



CENTURION BOATS
2026 OWNERS MANUAL

FUEL SYSTEMS

Boats manufactured for use in California for model year 2018 and after meet the California EVAP Emissions regulation for spark-ignition marine watercraft. Boats meeting this requirement will have the following label affixed near the helm.

WARNING

Operating, servicing and maintaining a recreational marine vessel can expose you to chemicals including engine exhaust, carbon monoxide, phthalates and lead, which are known to the State of California to cause cancer and birth defects or other reproductive harm. To minimize exposure, avoid breathing exhaust, service your vessel in a well-ventilated area and wear gloves or wash your hands frequently when servicing this vessel. For more information go to: www.P65warnings.ca.gov/marine

The fuel system in boats marketed in states other than California complies with U.S. EPA-mandated evaporative emission standards at time of manufacture using certified components.

CALIFORNIA AIR RESOURCES BOARD (CARB)

Outboard, sterndrive and inboard powered boats sold in the state of California are equipped with special components and certified to meet stricter environmental standards and exhaust emissions. All boats sold in California since 2009 are required to meet Super-Ultra-Low (four-star) emissions.

EXHAUST EMISSIONS



Sterndrive and inboard marine engine powered boats meeting CARB's exhaust emission standards are required to display the four-star label on the outside of the hull above the waterline. Outboard and personal watercraft marine engines may also comply with these standards.

DANGER

Carbon monoxide (CO) can cause brain damage or death. Engine and generator exhaust contains odorless and colorless carbon monoxide gas. Carbon monoxide will be around the back of the boat when engines or generators are running. Signs of carbon monoxide poisoning include nausea, headache, dizziness, drowsiness and lack of consciousness. Get fresh air if anyone shows signs of carbon monoxide poisoning. See engine manufacturer's manual for information regarding carbon monoxide poisoning.

TABLE OF CONTENTS

Introduction	1-1
Congratulations	1-1
About This Manual	1-1
About Your New Boat	1-3
Boat Terminology	1-3
Construction and Features	1-3
Hull Identification, Capacity and Safety Plates	1-5
Design Category	1-6
Disclaimer	1-7
References and Contact Information	1-7
Boat Information Form	1-10
Warranty	2-1
Limited Warranty Statement	2-1
Section 1. Disclaimer and Limitation of Implied Warranties:	2-1
Section 2. Limited Warranty (“Limited Warranty”) and its Duration:	2-2
Section 3. Engine/Power Train and Trailer/Trailer Component Parts:	2-3
Section 4. Limited Warranty Conditions, Limitations and Exclusions:	2-5
Section 5. Limitation of Liability:	2-8
Section 6. Warranty, Warranty Registration and Warranty Transfer	2-8
Safety	3-1
General Safety	3-2
Good Boating Practices	3-2
Tow Boat Safety	3-4
Water Sports Safety Code	3-5
Water Sport and Towing Safety	3-7
Water Sport Tips	3-13
Safety Decals and Statements	3-20
Safety Decals	3-20
Safety Statements	3-25
Safety Precautions	3-26
Carbon Monoxide (CO)	3-29

Required Boating Safety Equipment and Regulations	3-31
Fire Extinguisher	3-33
Life Jackets	3-34
Audible Signaling Devices	3-39
Visual Distress Signaling Devices	3-39
Engine Emergency Stop Switch and Lanyard	3-42
Navigational Lights	3-43
LED Lighting	3-43
Recommended Safety Equipment	3-44
Safety and Training	3-45
Situational Awareness	3-45
Driving Defensively	3-45
Boat-Sharing Safety	3-46
Small Boats and Swimmers	3-46
Knowing the Boat	3-46
Special Needs Passengers	3-47
Cruising Limitations	3-48
Hazard Information	3-48
Water Sports	3-49
Develop Water Sense	3-49
Platform Dragging	3-49
Water Sports Guidelines	3-50
Seating Locations	3-54
Designated Seating Positions	3-54
Boating Regulations and Your Responsibilities	4-1
Boat Owner / Operator Responsibilities	4-1
Safety	4-2
Registration	4-2
Insurance	4-2
Reporting Accidents	4-3
Boating Under the Influence	4-3
Operator's License and Education	4-3
Operation By Minors	4-4
Emergency Assistance	4-4
Negligent Operation	4-4
Protecting the Environment	4-5
MARPOL Treaty	4-6
Aquatic Invasive Species (AIS)	4-6
Paints	4-7

Cleaning Agents	4-7
Exhaust Emissions	4-7
Noise	4-8
Speed	4-8
Wake	4-8
Restricted Areas	4-8
Security Zones	4-8
Naval Vessel Protection Zones	4-8
Commercial Shipping Safety Zones	4-9
Bridges and Shipping Channels	4-9
America's Waterway Watch	4-9
Fishing	4-9
Monofilament Fishing Line	4-10
Emergencies	5-1
First Aid / Medical Emergencies	5-1
Emergency Preparation Checklist	5-1
Law of Salvage	5-1
Fire and Explosion	5-2
Man Overboard (MOB)	5-3
Capsizing and Flooding	5-4
Running Aground	5-5
Dangerous Weather	5-5
Engine or Boat System Failure	5-5
Accidents, Collisions and Giving Assistance	5-6
Towing on the Water	5-6
Hurricane and Severe Weather Preparedness	5-7
Protecting the Boat from Theft	5-8
Operating in Hazardous Conditions	6-1
Severe Weather	6-1
Storm Conditions	6-1
Fog Conditions	6-2
Reduced Visibility	6-2
Cold Weather	6-2
Water Hazards	6-3
Aquatic Vegetation / Weeds	6-3
Dams and Spillways	6-3
Shallow Water Operation	6-3
Markers, Warnings and Advisories	6-4
Boat Flags	6-4
Harbor Flags and Indicators	6-5

Navigation Rules and Aids	7-1
Rules of the Road	7-1
Right-of-Way	7-1
The General Prudential Rule	7-2
Audible Signals	7-2
Overtaking / Passing	7-3
Meeting Head-On	7-4
Crossing	7-5
Aids to Navigation	7-6
Buoys	7-6
Mooring Buoys	7-7
Daymarks / Dayboards	7-7
Lights and Lighted Structures	7-8
Markers	7-9
Navigational Lights and Night Operation	7-13
Helm and Controls	8-1
Helm	8-1
Switches and Breakers	8-4
Observer Seat Storage Compartment	8-4
Power Switch Panel	8-4
RI Switch Panel	8-5
NV Switch Panel	8-6
Fe Switch Panel	8-7
Engine Emergency Stop Switch and Lanyard	8-8
Neutral Start Safety Switch (Start-in-Gear Prevention)	8-9
Navigation Lights Switch	8-9
Blower Switch	8-9
Bilge Pump Switch	8-9
Horn Switch	8-9
Courtesy and Docking Light Switch	8-10
Tower Light Switch (Optional)	8-10
Trim Tab Switch (Optional)	8-10
Ballast Tank Switch (Optional)	8-10
Cockpit Heater Switch (Optional)	8-11
Shift and Throttle Controls	8-11
Captive Touch SxS HD Dash System (Ri Series Models)	8-13
Driver's Power Command Center	8-13
Dash Controls	8-13
Powering Up Your System	8-14

Accessories	8-14
Shutting Down Your System	8-14
Features	8-15
Centurion Ri Configuration	8-15
Right Display	8-15
Left Display	8-62
Centurion Fe Configuration	8-71
Display	8-71
Centurion Nv Configuration	8-106
Display	8-106
Features and Options	9-1
Tow Boat Technology	9-1
Centurion Articulating Tracking System (CATS)	9-1
Ballast Tank Plumbing and Pumps	9-2
Ballast Tank System (Optional)	9-2
Ramfill	9-4
Ramfill Ballast Operation	9-5
Plug N' Play Ballast System	9-5
Trim Tab / Stinger Wake Plate (Optional)	9-5
QuickSurf Pro	9-6
Stinger Wake Plate	9-7
Silent Stinger Wake Plate	9-8
Wake Tower (Optional)	9-8
Battle Advance Tower	9-9
Dropzone Auto Tower	9-9
Predator Power Tower	9-9
Steering System	9-10
Mechanical Steering	9-10
Hydraulic Steering	9-11
Electric Steering	9-11
Electronic Steering	9-11
Fuel System	9-12
Engine Cooling System	9-12
Engine Exhaust System	9-13
Engine Lubrication System	9-13
Electrical System	9-13
DC System	9-13
Batteries	9-14
Bilge Pump System	9-15
Propeller Strut	9-15

Table of Contents

Propellers	9-17
Propeller Selection and Replacement Guidelines	9-18
Engine Compartment Ventilation System	9-19
Cockpit Heater System (Optional)	9-19
Centurion Shift Driver Assist (Optional)	9-19
Operating the Boat	10-1
Before Getting Underway	10-1
Safety Equipment	10-1
Filing a Float Plan	10-2
Pre-Departure Safety Checklist	10-2
Boarding	10-3
Using the Boarding Platform / Ladder	10-4
Boat Loading	10-5
Fueling	10-6
Fuel Management	10-6
Fuel Suppliers	10-6
Static Electricity and the Fuel System	10-6
Fuel (Gasoline)	10-7
Before Refueling	10-8
Fueling	10-9
Refueling Built-In Fuel Tanks	10-9
After Refueling	10-9
Getting Underway	10-10
Starting	10-10
Steering	10-11
Shifting	10-12
Stopping	10-13
Accelerating and Running Underway	10-14
Checks During and After Operation	10-16
Docking	10-16
Mooring	10-17
Anchors and Anchoring	10-18
Lines and Knots	10-20
Trailering and Launching	11-1
Legal Considerations	11-1
Trailer Classification	11-1
Trailer Type	11-2
Trailer Gross Vehicle Weight Rating	11-2
Towing Vehicle	11-2
Vehicle Towing Hitch	11-2

Hitch Ball and Trailer Coupler	11-3
Safety Chains	11-4
Trailer Brakes	11-5
5-Pin Wiring Connector	11-5
Trailer Guidelines	11-6
Backing Up	11-9
Launching	11-9
Loading Guidelines	11-11
Reporting Safety Defects	11-11
General Care and Maintenance	12-1
Hull Discoloration	12-1
20-Hour Inspection	12-2
25-Hour Engine Inspection	12-2
Periodic Maintenance	12-3
Engine	12-3
Fuel System	12-3
V-Drive	12-4
Steering System	12-4
Electrical System	12-5
Batteries	12-5
Circuit Breakers and Fuses	12-8
Corrosion Protection	12-9
Galvanic Corrosion	12-9
Saltwater Corrosion	12-10
Hardware, Fasteners and Fittings	12-11
Stainless Steel and Chrome Hardware	12-11
Aluminum Hardware	12-12
General Maintenance and Cleaning	12-12
Replacement and/or Modification of	
Navigation Lights	12-12
Marine Growth	12-12
Cleaning	12-13
Hull	12-13
Upholstery	12-13
Canvas Covers and Bimini Tops	12-14
Carpet	12-14
Windshield	12-14
Bilge System	12-14
Bilge Pump	12-14
Cockpit Heater	12-14
Trim Tab / Stinger Wake Plate	12-14

Table of Contents

Window Channels.....	12-15
Teak	12-15
Ballast Tanks	12-15
Safety Equipment.....	12-16
General Boating Equipment.....	12-16
Trailer.....	12-17
Winterization and Storage.....	13-1
Winterization and Storage Preparation	13-1
Engine and V-Drive Winterization	13-3
Storing on a Cradle or Blocks	13-3
Storing on a Trailer	13-4
Storing During the Summer	13-4
Recommissioning After Storage	13-4
Lifting.....	13-6
Troubleshooting	14-1
Glossary of Nautical Terms.....	15-1
Index	I-1

CENTURION BOATS

Section 1

INTRODUCTION

CONGRATULATIONS

You have just become a member of the Centurion Boats family. This manual contains recommended maintenance procedures to be used in the care of your new boat. It is important that you read this information and familiarize yourself with all the boat systems prior to operating or hauling your new Centurion boat.

First read the warranty and disclaimer enclosed, then make sure your warranty activation card has been sent to Fineline Industries to activate your warranty. If you have any questions after reading this manual, please contact your local authorized Centurion dealer.

Our mission at Centurion Boats is to continually strive to build the finest product in the market place. We have set our standards high and would like you, our customer, to know that we build pride into every boat model manufactured here at Centurion Boats. One hundred percent customer satisfaction is the goal we strive to achieve daily.

ABOUT THIS MANUAL

Please keep this *Owner's Manual* on-board for future reference and pass it along to the new owner if you ever decide to sell the boat.

This manual has been written as a general guide to safe operating practices, boating regulations and maintenance techniques for recreational boating. If this is your first time owning or operating a boat, it is recommended that you contact the boat dealer or local boating agency to find out how to enroll in a boater safety course prior to operating the boat.

This manual is not intended to be used as a replacement for specific information and procedures covered in manuals provided by the manufacturer of the engine, accessories and other major equipment.

Section 1

Suppliers of some of the major components in your boat provide care and operation information that has been included with your boat in your *Owner's Information Kit*. Read the information in this manual and the information in the *Owner's Information Kit* completely before operating your boat or any equipment.



Because we are constantly working toward product improvement, this manual is intended to be a general guide only. The illustrations used in this manual may not match the equipment on the boat; they are intended only as general reference views.

This information is supplied with the understanding that the boat will be operated with good seamanship and attention to safe loading, safe operating conditions and safe speed. The manner in which the boat is loaded and operated is the responsibility of the operator. The following elements should be considered for inclusion in the owner/operator's manual.

ABOUT YOUR NEW BOAT

BOAT TERMINOLOGY

It is important that you understand, learn and use appropriate and common nautical terminology while boating to ensure operator safety and the safety of others.

See the *Glossary of Nautical Terms* section of this manual for additional boating terminology.

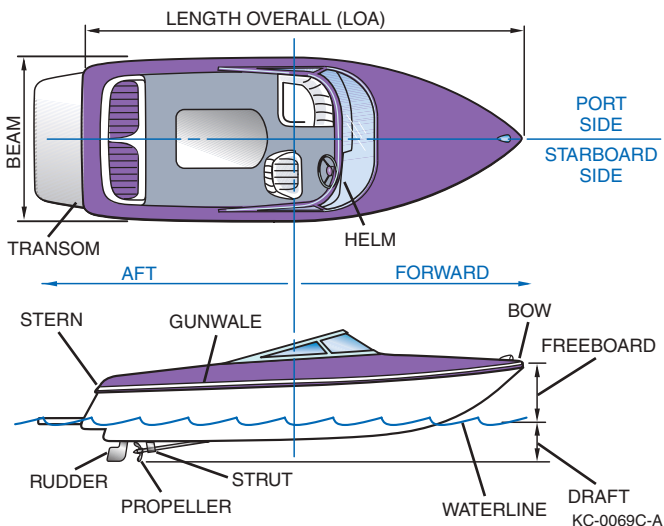

CONSTRUCTION AND FEATURES

Construction begins outside-in, with our Integrated Composite System (ICS). ICS is a 100% composite design that makes each Centurion Boat strong and uses a three-piece construction process — hull, inner liner and deck. During construction, gelcoat colors and full-contour graphics are sprayed into the molds, which ensure that Centurion tow boats' accents and graphics last all the way to the horizon.

After the gelcoat and fiberglass are applied and dried, giving the three ICS components solid form, the deck, hull and liner are removed from their molds and placed together. First, the inner liner is placed into the hull and bonded using a material called Plexus[®], which fuses fiberglass, creating an unbreakable seal. The inner liner is then injected with foam to reduce noise and vibration, and the injection points are sealed with additional fiberglass, ensuring there is no exposure to water while your boat is underway.

Section 1

Electrical wiring, gas tanks and underwater gear components are installed before the final ICS pieces are added. The deck is then placed in the hull using a “Reverse Shoebox” method, which reduces the influx of water into the boat through the rub rail and creates the strongest bond possible. Plexus is applied to the hull and deck and then tightened together using stainless steel screws, allowing the Plexus to take effect.

Final assembly is made with the installation of a Pleasurecraft Marine Engine Company (PCM) engine, final drive system components and interior boat features. When assembly is completed the boat is lake-tested and detailed.

Centurion Boats is dedicated to revolutionizing towboat performance. In our testing and development facilities we work passionately on the water to develop new ways to push Centurion Boats ahead of the pack. Visit us at: www.centurionboats.com

So, whether you're just cruising on one of our boats or seriously competing behind one, here are a few Centurion innovations that will help you carve the waves (Features not available on all models):

- **Integrated Composite System (ICS) Construction**
Integrated Composite System is composed of a three-piece process that combines hull, inner liner and deck, which results in 100% composite designs that are strong and light.
- **GatorStep Flooring**
GatorStep provides an excellent look and feel and uses marine-grade 3M™ adhesive, which provides unmatched stability.
- **Gelcoat Graphics**
Most graphics and colors are generated by a computer-rendered graphic system and are applied into the gelcoat. Centurion Boats stand alone when it comes to gelcoat graphics.

HULL IDENTIFICATION, CAPACITY AND SAFETY PLATES

Hull Identification Number

The hull identification number (HIN) is located on the upper right-hand side of the transom just below the rub rail.

The HIN must be clearly visible and may not be removed, altered or tampered with in any way as regulated by federal law.

In case of collision, theft or damage, report these numbers to the local authorities, your insurance agent and your dealer. Safeguard information about your boat by recording the HIN and model of your boat and model and serial numbers of the engine, trailer and accessories on the *Boat Information Form* on Page 1-10.



Certification Standards

The boat was built to meet federal USCG requirements and *may* be certified to more stringent American Boat & Yacht Council (ABYC) standards for the fuel, electrical, ventilation, flotation, horn, identification, capacity, placards and labels, powering, start-in-gear protection, navigation lights, backfire flame control and in most cases, fire extinguishers.

Section 1

The boat owner is responsible for other USCG-required safety items, which can vary depending on the size of the boat as follows:

- Fire Extinguishers
- Life Jackets
- Visual Distress Signals
- Audible Signaling Device. Boats greater than 65 feet (20 meters) in length must have a bell.

The boat manufacturer or dealer may provide some required safety items. Your boat *may not* be certified to ABYC standards; check the capacity plate for more information.

The person/load capacity is determined by the USCG. The capacity plate is usually located within clear visibility of the boat operator or helm area. The capacity plate indicates limits for loading the boat, which are enforceable by law. Never exceed the “U.S. Coast Guard Maximum Capacities” indicated on the capacity plate.

Boats in the National Marine Manufacturers Association (NMMA) Certification program up to 26 feet (7.9 meters), or a pontoon boat of any length, are certified to ABYC standards, have the USCG maximum rated load capacity on the certification plate and may contain EPA and/or CARB emission information. Do not exceed maximum person or weight capacities. Add the weight of all persons on board; the total weight must not exceed the maximum weight capacity, so it is possible that fewer people than the maximum number can safely ride in the boat.



KCB-0008

U.S. Coast Guard Safety Standards Compliance Plate

All power boats less than 20 feet (6 meters) must have a manufacturer’s compliance plate clearly indicating that your boat is in compliance with the USCG safety standards and the effective date of the compliance. The compliance plate may be combined onto one plate showing both the capacity plate and compliance information by the manufacturer.

DESIGN CATEGORY

Watersport tow boats are designed for use in typical conditions in sheltered waters; Category D. A watercraft given design category D is considered to be designed for a wind force up to, and including, 4 (Beaufort Scale) and significant wave height up to, and including, 1 foot (0,3 m), with occasional waves of 1.5 feet (0,5 m) maximum height. Wave heights over 1 foot (0.3 m) make tow boating uncomfortable. Waves over 3 feet (1.0 m) can be dangerous and should be avoided.

If you use your tow boat in the Great Lakes or ocean, you should confine your cruising primarily to bays and inlets and constantly monitor the weather for changes. A tow boat is not made to be a big water craft and as such can only be used if the water conditions are similar to an inland lake and only close to shore.

DISCLAIMER

This Owner's Manual is provided for information and educational purposes only and is not intended to offer or provide legal advice or create a contractual relationship. Please be aware that as a boat owner, you have responsibilities regarding the safety, maintenance, fitness and operation of the boat which cannot be delegated to anyone else. The extent of such responsibilities is ultimately determined by Federal law and regulations, the general maritime law of the United States, the laws and regulations of the states and territories of the United States, or the laws and regulations of the country where you operate the boat.

REFERENCES AND CONTACT INFORMATION

Use the following list of publications and organizations for reference and contact information concerning safe boating, navigational rules and other boating topics.

Publications

- Bottomley, Tom. *Boatman's Handbook*. Hearst Marine Book. Morrow
- Brotherton, Miner. *Twelve Volt Bible*. Seven Seas
- Calder, Nigel. *Boatowner's Mechanical and Electrical Manual*. McGraw-Hill Education
- Chapman, Charles F. and Maloney, E.S. *Chapman's Piloting, Seamanship and Small Boat Handling*. Hearst Marine Book. Morrow
- Hinz, Earl. *The Complete Book of Anchoring and Mooring*. Cornell Maritime Press
- National Fire Protection Association. *NFPA 302 Fire Protection Standard for Pleasure and Commercial Motor Craft*. National Fire Protection Association
- United States Coast Guard. *Navigational Rules for U.S. Waterways*. Visit <https://www.navcen.uscg.gov/> to view or download this publication.
- United States Coast Guard Auxiliary. *Boating Skills and Seamanship Thirteenth Edition*. United States Coast Guard
- Whiting, John and Bottomley, Tom. *Chapman's Log and Owner's Manual*. Hearst Marine Book

Section 1

Organizations

American Boat & Yacht Council

Boat building standards.
<http://abycinc.org>

American Red Cross

A resource for first aid training, emergency supplies and preparedness.
<http://www.redcross.org> or consult the local telephone directory

Boat Owners Association of The United States

Organization of recreational boaters offering marine services, education and protecting boater's rights.
<http://www.boatus.com/>

BoatU.S. Foundation for Boating Safety Hotline

Training and education outreach directly to boaters.
<http://www.boatus.org/>
Phone: 800-245-2628

National Association of State Boating Law Administrators

Boat safety training and education resources.
<http://www.nasbla.org>

National Marine Manufacturers Association

Boat, marine engine and accessory manufacturer trade association.
<http://www.nmma.org>

National Oceanic and Atmospheric Administration's National Weather Service

Nautical charting, weather, fishery, ocean and climate resources.
<http://www.noaa.gov>

National Safe Boating Council, Inc.

<http://www.safeboatingcouncil.org>

Sea Tow Services International, Inc.

Organization of recreational boaters providing towing and more.
<http://www.seatow.com>
Toll free: 800-473-2869

U.S. Coast Guard

<http://www.uscgboating.org> (To contact the U.S. Coast Guard for an emergency while on the water, always use the onboard VHF-FM radio channel 16. Use cell phones only as a secondary means of communication. Call 9-1-1 to reach rescue personnel.)

U.S. Coast Guard Auxiliary

Information on boating safety classes and boat safety checks.
<http://nws.cgaux.org>; Phone: 877-875-6296

U.S. Coast Guard Navigation Center (NAVCEN)

USCG navigation information.
<https://www.navcen.uscg.gov>

U.S. Coast Guard Office of Boating Safety

USCG resources for recreational boaters.
<http://www.uscgboating.org>

U.S. Coast Guard's America's Waterway Watch Program

A program for recreational boaters to assist the U.S. Department of Homeland Security in reporting suspicious activity on U.S. waterways; Phone: 877-249-2824

U.S. Government Publishing Office

<http://www.gpo.gov>
(For information and documentation on FCC rules and regulations and Skippers Course information, and other government, marine and nautical related documents)

U.S. Power Squadrons

Boating courses and knowledge resources.
<http://www.usps.org>; Phone: 888-367-8777

Water Sports Industry Association

Water sports education, safety and risk management.
<http://www.wsia.net>

BOAT INFORMATION FORM

BOAT	
Boat Manufacturer:	
Hull Colors:	
Weight:	
Length:	
Draft:	
Beam:	
Vertical Clearance:	
Dealer:	
Dealer Representative:	
Dealer Phone:	
Boat Model:	
Hull ID Number (HIN):	
Registration Number:	
Registration State:	
Purchase Date:	
Delivery Date:	
Warranty Expiration Date:	
Manufacturer Representative:	
Manufacturer Phone:	
ENGINE, DRIVE AND PROPELLER	
Engine Make:	
Engine Model Number:	
Engine Serial Number:	
Ignition Key Number:	
Drive Make:	
Drive Model Number:	
Drive Serial Number:	
Propeller	Make/Type:
	Size/Material:
	Part Number:

SYSTEMS	
Fuel Filter Part Number:	
Battery Make:	
Battery Size:	
TRAILER	
Trailer	Make:
	Model Number:
	Serial Number:
	GVWR:
	Tire Size:
ACCESSORIES	
Manufacturer:	
Model:	
Serial Number:	
Manufacturer:	
Model:	
Serial Number:	
Manufacturer:	
Model:	
Serial Number:	
Manufacturer:	
Model:	
Serial Number:	
Manufacturer:	
Model:	
Serial Number:	

This Page Intentionally Left Blank

CENTURION BOATS

Section 2

WARRANTY

LIMITED WARRANTY STATEMENT

SECTION 1. DISCLAIMER AND LIMITATION OF IMPLIED WARRANTIES:

THE EXPRESS LIMITED WARRANTY SET FORTH HEREIN BELOW IS EXCLUSIVE AND IN LIEU OF ALL OTHER WARRANTIES, TERMS AND CONDITIONS, EXPRESS OR IMPLIED, EITHER IN FACT OR BY OPERATION OF LAW, STATUTORY OR OTHERWISE. FINELINE INDUSTRIES, LLC. DISCLAIMS, AND THE OWNER HEREBY EXPRESSLY WAIVES, TO THE MAXIMUM EXTENT PERMITTED BY APPLICABLE LAW, ANY AND ALL OTHER WARRANTIES OR REPRESENTATIONS OF ANY KIND OR NATURE, INCLUDING, BUT NOT LIMITED TO, THE IMPLIED WARRANTIES OF MERCHANTABILITY AND FITNESS FOR A PARTICULAR PURPOSE. Some states or provinces do not allow the exclusion or limitation of implied warranties, as such the above limitations and exclusions may be limited in their application to Owner. When the implied warranties are not allowed to be excluded in their entirety, they will be limited to the duration of the express warranty periods applicable to the respective components.

This Limited Warranty gives you specific legal rights. You may have other rights, which vary from state to state.

SECTION 2. LIMITED WARRANTY (“LIMITED WARRANTY”) AND ITS DURATION:

Fineline Industries, LLC. (“Centurion”) warrants to the original retail purchaser that the following components of each new and unused boat manufactured by Centurion shall be free from material defects in materials and workmanship to the extent set forth below, under normal use and service when operated and maintained in accordance with Centurion’s instructions, beginning on the date of the original retail delivery date of the boat by purchaser from an authorized Centurion dealer for the period indicated in this Section:

- **Lifetime Limited Warranty:** Fineline Industries, LLC, exclusive manufacturer of Centurion Boats, and also referred to as Centurion herein, warrants to the original purchaser, of each new Centurion boat, that the deck, hull, and stringer system, as originally manufactured by Centurion, shall, under normal authorized use, remain free from structural defect in material and workmanship. For purposes of this warranty, the terms “Fineline Industries, LLC” and its trademark “Centurion” are used interchangeably to refer to Fineline Industries, LLC., exclusive manufacturer of Centurion brand boats.
- **Gel Coat Two (2) Year:** For a period of two (2) years commencing on the date the boat is delivered by the first retail purchaser through an authorized Centurion dealer, the boat’s gel coat finish, under normal authorized use, shall remain free from defect in material and workmanship (including: cracks NOT caused by negligence, impact or collision). This warranty right is subject to and conditioned upon the owner having provided regular maintenance and care to this component as described in the Centurion Owner’s Manual. This Gel Coat limited warranty shall not extend to, and Centurion hereby expressly disclaims responsibility for, Gel Coat damages including finish blistering, discoloration, thermal cracking, fading or osmosis. Centurion Boats uses the highest-grade gel coat materials. Conditions can develop where the bottom of the boat may show signs of discoloration and/or blisters if the boat is left in the water for extended periods of time; therefore, a proper barrier coat and bottom paint should be used whenever it is anticipated that the boat will be left in the water for an extended period of time. If you have not applied a bottom paint or barrier coat we recommend that you do not leave the boat in the water for an extended period of time without removing, drying and cleaning. Damaged or discoloration to the gel coat from moisture or other impurities between the gel coat and storage cover.

- **Five (5) Year Base Limited Warranty:** Except for the engine, transmission and components parts described elsewhere, Centurion warrants to the original retail purchaser or authorized transferee (as described below) that the components of each new Centurion boat, as originally manufactured by Centurion and not modified by Owner, shall under normal use and service be free of defect in material and workmanship for a period of five (5) years or five hundred (500) hours (whichever occurs first) from the date of delivery to the original retail purchaser. The components identified herein below are subject to the following warranty terms, policies and conditions:
 - Instrumentation, including touch screens, and gauges, is warranted for 3 years parts and labor and an additional 2 years for parts only.
 - Audio and electronics systems are warranted for 3 years.
 - Non-Skid flooring is warranted for 3 years against all adhesion.
 - Upholstery vinyl and stitching material is warranted for 3 years parts and labor and an additional 2 years for parts. (Do not use any Citrus based cleaners this will void warranty)
 - Mooring cover has a 1 year manufacture warranty from defects in material and workmanship and 10 year limited warranty on WeatherMax 80 fabric from color or strength loss from normal usage through Great Lakes Boat Top
 - Roswell tower's are warranted for 5 years Limited Parts & Structure, 2 years Limited Esthetic and 3 years Limited Wearables
 - Bimini, Roswell is 5 years Limited Structure and 1 year Limited Canvas
 - Bimini, SewLong, guarantee's their products to be free of any defects in material or craftsmanship for regularly maintained products under normal use and environmental conditions for the expected life of the product.
 - Centurion Surge Thruster System by ezDrive; ezDrive Thruster issues to the original purchaser, a 2 year limited warranty for pleasure use and 1 year for commercial use on the purchase of the ezDrive.
 - RECON (Remote Engagement Continuous Optimization Newwork) telematics by Osmosis 5 year warranty.

SECTION 3. ENGINE/POWER TRAIN AND TRAILER/TRAILER COMPONENT PARTS:

- **Engine/Power Train:**

The engines used in Centurion boats are not manufactured or warranted by Centurion. They are supplied to Centurion by Pleasurecraft Marine Engine Company (PCM), which offers a separate warranty to owners with the following coverage by engine from the date of the original retail purchase of the boat for the engine and power train.

Section 2

ENGINE	COVERAGE
Centurion Power by GM Marine 100% Freshwater Cooled ZZ5 5.3L/400lb-ft/2:1GR/1.25" DS	5 yrs/ 1000 hrs.
Centurion Power by GM Marine 100% Freshwater Cooled ZZ5 Saltwater Ed 5.3L/405lb-ft/2:1GR/1.25" DS (4wk leadtime after confirmation)	5 yrs/ 1000 hrs.
Centurion Power by PCM Marine 100% Freshwater Cooled ZZ6 6.2L/465lb-ft/2:1GR/1.25" DS	5 yrs/ 1000 hrs.
Centurion Power by PCM Marine 100% Freshwater Cooled ZZ6 Engine, 6.2L DI V-Drive, Catalyst, BSO Certified "International Only"	5 yrs/ 1000 hrs.
Centurion Power by PCM 100% Freshwater Cooled ZZ6 Saltwater Ed 6.2L/465lb-ft/2:1GR/1.25" DS (4wk leadtime after confirmation)	5 yrs/ 1000 hrs.
Centurion Power by GM Marine 100% Freshwater Cooled Saltwater Ed ZZ8S 6.2L/665lb-ft/1.72:1 GR	5 yrs/ 1000 hrs.
Centurion Power by GM Marine 100% Freshwater Cooled ZZ8S 6.2L/665lb-ft/1.72:1 GR	5 yrs/ 1000 hrs.

Centurion provides no independent warranty with regard to the engine and transmission; however, the owner may contact Centurion to obtain contact information for making claims or inquiries under the applicable engine manufacturer's warranty. Owner should refer to Pleasurecraft Marine Engine Company Owner's Manual and warranty documents for further information on terms and conditions of the engine/power train warranty.

- **Trailer and Trailer Component Parts:**
BoatMate Trailers:

Trailer and trailer component parts are not manufactured or warranted by Centurion. Boatmate Trailers, LLC ("Boatmate") will facilitate all warranty claims based on the coverage set forth by the encompassing terms, conditions, and limitations for the duration of 5 years from the in-service date or 6 years from the date of manufacture, whichever comes first. The in-service date refers to the first date in which the trailer is either delivered to the ultimate purchaser or used as a commercial or demonstrator trailer. In the case of a component manufacturer providing a Limited Lifetime Warranty, once the 5 Year Limited Boatmate Trailer Warranty expires lifetime warranty claims will need to be filed with the appropriate Manufacturer offering said warranty.

SECTION 4. LIMITED WARRANTY CONDITIONS, LIMITATIONS AND EXCLUSIONS:

This Limited Warranty, as further described in Section 2, constitutes the final, complete and exclusive statement of warranty terms, and supersedes any and all prior written and oral statements or representations concerning the warranty on the boat. Centurion neither assumes or authorizes any other person to extend or expand upon any warranty right or grant further warranty rights on the boat or its components.

Centurion reserves the right to improve its products through changes in design or material without being obligated to incorporate such changes in products of prior manufacture.

The Limited Warranty set forth in Section 2 (including all subsections therein) DOES NOT cover or extend to any of the following:

- All warranty repairs must be performed in the country of purchase. This applies to the original first owner purchase only. Warranty will not be honored in cross-international-borders on first purchases. (This will not apply to 2nd owner warranty transfers. All 2nd owner transfers must be done at a authorized dealer).
 - Normal maintenance of boat, or any component thereof, including but not limited to, vinyl care, alignment, adjustments, connectors, corrosion, discoloration, and wear items including, but not limited to, non-skid material, battery, bushings, packing material, bulbs, seals, gaskets, impellers, carpet backing, wearable tower accessories/parts.
 - Damage to boat due to using a non-Centurion authorized mooring cover including but not limited to vinyl or gelcoat;
 - Damage caused by misuse, neglect, negligence, accident, collision or impact with any object.

Section 2

- Damages caused by heat, fire, explosion or freezing/thermal cracking, including, but not limited to, damages resulting from the failure to perform proper winterization of the boat and proper storing of boat during extreme temperature conditions;
- Damage caused by the use of improper or contaminated fuel or fluids;
- Damage caused by failure to maintain the boat in accordance with the maintenance provisions in the Owner's Manual, by improper maintenance of the boat or by service furnished from unauthorized repair and service providers;
- Damage caused by the installation of non-Centurion materials, components or parts. Damage caused by aftermarket cleaning products or non-Centurion approved additives;
- Damage caused by the failure to comply with any recall or request for repair;
- Damage caused by lightning, hail, rain, flooding, wind, sand, floods, extreme temperatures or other environmental or natural conditions;
- Damage caused by theft or vandalism;
- Damage caused by atmospheric fallout, chemical treatments, tree sap, salt, ocean spray, corrosion caused by salt water, mold, or animal droppings;
- Damage resulting from the use of the boat for any racing, speed, commercial competition or performance demonstration;
- Damage resulting from use of the boat for rental, commercial or industrial purposes; and the use of the boat for anything other than recreational purposes;
- Damage due to insufficient or improper maintenance, including use of oils, lubricants or fluids other than those recommended in the boat's Owner's Manual;
- Damage to any component parts and accessories not manufactured by Centurion, including but not limited to, the engine, drivetrain, transmission, propeller, shift and throttle control levers and cables, pumps, blowers, windshields, canvas, tower and accessories, instrumentation and steering systems; however, such items may be warranted by the individual manufacturer, and where applicable, Centurion will furnish the owner with a copy of the manufacturer's warranty;
- Damage caused by davits, a hoist system or boat lift of any kind that is utilized to support the boat;
- Manufacturing variations or imperfections in cosmetic, convenience or aesthetic components or features of the boat, including the gel coat finish, which have no substantial impact on the use, value or safety. As the gel coat finish is applied manually by a Centurion craftsman, minor distortions or imperfections may be found in certain areas of the boat. Such distortions and imperfections are considered normal and not subject to warranty coverage and repair;

Damage to paint, varnishes, gel coat surfaces and colors, chrome-plated or anodized finishes, floor and floor covers and any other surface coatings, as well as damage resulting from in-water storage without proper barrier coat and bottom paints.

NOTE — Although Centurion uses the highest-grade gel coat materials, a condition may develop where the bottom of the boat may show signs of discoloration and/or blisters if the boat is left in the water for long periods of time. To properly protect the boat, we recommend boat users apply a proper barrier coat and bottom paint whenever it is anticipated that the boat will be left in the water for an extended period of time without removing, drying and cleaning. Damaged or discoloration to the gelcoat from moisture or other impurities between the gelcoat and storage cover.

- Damage caused by overloading, improperly weighting or overpowering the boat;
- Damage caused by use of any trailer not sold through Centurion for the boat;
- Damage caused by water intrusion into any part of the boat (including the glove box);
- Damage caused by dealer-installed or consumer-installed options or accessories;
- Any and all expenses including, but not limited to, costs incurred for haul-out, launching, towing, and storage charges, telephone, expedited shipping of replacement parts, or rental charges of any type (including slip fees);

The following events will discharge Centurion from its obligations under the Centurion Limited Warranty:

- Unauthorized disconnection, tampering with, or altering of the boat's hour meter;
- Unauthorized disabling of any Centurion installed warning device or system;
- Unauthorized disconnection, disturbance or compromise of any wires, hoses, tubes, cables, looms or other components of the boat's electrical or fuel systems;
- Determination by any state or federal entity or private insurance carrier that the boat is a total loss of value or fit only for salvage.

The Limited Warranty does not provide coverage to any boat which has ever been:

- A repossession from a retail customer;
- Purchased from a salvage yard;
- Purchased from an auction;
- Purchased from an insurance company that obtained the product as a result of an insurance claim.

The Limited Warranty does not cover the costs of maintenance, which includes, but is not limited to, boat inspections, lubrication, engine tune-ups, replacement of filters, coolants, spark plugs, bulbs, fuses, impellers, packing material, cleaning and polishing.

SECTION 5. LIMITATION OF LIABILITY:

- **Liability Limitation-Exclusion of Consequential Damages:** This Limited Warranty is for the benefit of the owner and Centurion, and shall not create or evidence any right in any third party. TO THE MAXIMUM EXTENT PERMITTED BY APPLICABLE LAW, CENTURION SHALL IN NO EVENT BE LIABLE FOR ANY INCIDENTAL, CONSEQUENTIAL, SPECIAL, INDIRECT, PUNITIVE OR EXEMPLARY DAMAGES OR LOST PROFITS WHATSOEVER ARISING OUT OF THE USE OR INABILITY TO USE THE BOAT OR ANY COMPONENT PART THEREOF, OR FOR ANY BREACH OF THIS LIMITED WARRANTY OR OTHERWISE, EVEN IF CENTURION HAS BEEN ADVISED OF THE POSSIBILITY OF SUCH DAMAGES OR SUCH DAMAGES COULD REASONABLY HAVE BEEN FORESEEABLE BY CENTURION. [Disclaimer: Some states do not allow the exclusion or limitation of incidental or consequential damages, so the above limitation or exclusion may not apply to you.]

SECTION 6. WARRANTY, WARRANTY REGISTRATION AND WARRANTY TRANSFER

- **Warranty:** In order to obtain warranty service under this Limited Warranty, the owner must notify the selling dealer in writing within (30) days after the discovery of any claimed defect and prior to initiating any repair. Centurion reserves the right to inspect and/or to require further evaluation and/or information regarding a warranty claim against a boat prior to its repair as well as designate the place of the warranty repair.

If you need assistance locating an authorized Centurion service facility, please visit our Centurion website at www.centurionboats.com or call Centurion at (209)384-0255.

Fineline Industries, LLC
Attention: Warranty/Customer Service Department
2047 Grogan Avenue
Merced, CA 95341
(209) 384-0255

Subject to the terms of this Limited Warranty, any covered boat or component part with a material defect in materials or workmanship that is returned to an authorized Centurion dealer's service department during the covered warranty period will be repaired or replaced, in Centurion's sole discretion, without charge to the customer. This provision is subject to the following terms and conditions:

- Centurion shall be responsible only to repair or replace those items that are defective, in Centurion's sole discretion, upon examination by a Centurion authorized dealer's service department or Centurion's own factory personnel;
- Centurion warrants its repairs and replacements only for the remainder of the applicable warranty period;

- Centurion shall, in its sole discretion, fulfill its responsibility to repair or replace any defective item at its authorized dealer's service department;
- The owner shall be responsible for all costs associated with the transportation of the boat, towing bills, trailer or component part(s) to the authorized Centurion service department and for any return transportation.
- **Warranty Registration:** Within seventy-two hours (72) of the first retail delivery date of a Centurion boat, the boat must be registered for product warranty purposes under applicable federal law, and the following steps must be performed in order to complete the warranty registration process for all Centurion boats:
 - Dealer is obligated to complete the warranty registration for the retail purchaser (boat owner) using Centurion's on-line dealer warranty system. The warranty registration card must be signed by the boat owner and scanned and submitted online in connection with the warranty registration for the boat owner.
 - Centurion should be notified promptly by owner of any change in address.

NOTE — This warranty is expressly conditioned upon the completion of the electronic registration to Centurion. This will enable Centurion to notify owners of any necessary performance or safety modifications to your boat, and to verify ownership in case a warranty claim is filed.

As the boat owner, you should ensure that the dealer has complied with this requirement. Warranty registration is vital.

- **Warranty Transfer:** In accordance with the provisions of the Centurion Limited Warranty, if the Centurion boat is subsequently sold by the original retail purchaser, a transferable warranty will be offered to the second retail owner only for the remaining unexpired warranty coverage provided under the Limited Warranty. This does not include the Gel Coat Two (2) Year or the Lifetime Warranty on the Structural Components (deck, hull, and stringers) as described in Section 2. The original retail purchaser can transfer on the condition that the sale of the boat by the original retail purchaser occurs within five (5) years or five hundred (500) hours (whichever occurs first) of the date of the original retail delivery of the boat. The Limited Warranty cannot be transferred on further retail sales or sales which are completed after the fifth (5th) year of ownership.
 - The Limited Warranty will be transferred upon the receipt and verification of:
 - ◆ The completed form below;
 - ◆ A copy of the sales agreement/invoice;
 - ◆ A payment of \$400, made payable to the Authorized Centurion Dealer

The transfer registration **MUST BE RECEIVED WITHIN 15 DAYS OF THE DELIVERY DATE**. With timely submission or transfer data, the warranty will be transferred retroactive to the delivery date.

This Page Intentionally Left Blank

CENTURION BOATS

Section 3

SAFETY

Safety is the number-one priority for Centurion Boats. Every Centurion boat is built to meet all applicable safety standards for water sports use; however, built-in safety mechanisms are never a substitute for good judgment. As a boat operator, you always take the responsibility upon yourself to operate your boat in a safe manner. Centurion continually strives to provide you with the best technology and information to keep you safe. If you ever have any safety-related questions, suggestions or concerns, please contact us directly.

Fineline Industries, LLC

2047 Grogan Avenue

Merced, CA 95341

Phone: 209-384-0255

GENERAL SAFETY

The popularity of boating and other water sports has undergone an explosion of growth in the past few years, making safety an important issue for everyone who shares in the use of the waterways.

 **WARNING** *Operation Hazard: Read and understand this Basic Boating and Safety Manual, the Engine Operator's Manual and all manufacturer-supplied information regarding the operation of equipment. The boat operator must understand all safety information responsibilities, regulations, controls and operating instructions before attempting to operate the boat. Improper operation could result in death or serious injury.*

The safety content and precautions listed in this manual and on the boat are not all-inclusive. If a procedure, method, tool or part is not specifically recommended, the operator must feel confident that it is safe for them and others, and that the boat will not be damaged or become unsafe as a result of the operator's decision. REMEMBER – ALWAYS ASSESS EACH SITUATION AND USE SOUND JUDGMENT!

The boat operator is responsible for their own safety, as well as that of passengers and other boaters.

GOOD BOATING PRACTICES

Boating-related accidents are generally caused by the operator's failure to follow basic safety rules or written precautions. Most accidents can be avoided if the operator is completely familiar with the boat, its operation and the navigational rules of the road and can recognize potentially hazardous situations.

In addition to everyday safety, failure to observe safety recommendations may result in severe personal injury or death to the operator or to others. Use caution and sound judgment when operating the boat. Do not take unnecessary chances! Failure to adhere to these warnings could result in death or severe injury to the operator and/or others.

Read this entire manual and be aware of other specific safety guidelines not listed in this manual. Seek additional safety information from the USCG and state and local authorities. In addition to specific safety statements noted in this manual, a general list of safety guidelines and recommendations is listed below:

- The boat must comply with USCG safety equipment regulations.
- Before each outing, check all safety equipment such as fire extinguishers, life jackets, flares, distress flags, flashlights and engine emergency stop switch. Make sure they are operable, in good condition, readily visible and easily accessed.
- Onboard equipment must always conform to the governing federal, state and local regulations.

- Never allow any type of spark or open flame on board. It may result in fire or explosion.
- Take the keys/FOBs when leaving the boat to keep untrained and unauthorized persons from operating the boat.
- Know how to react correctly to adverse weather conditions, have good navigation skills and follow navigational rules as defined by USCG, state and local regulations.
- Check local weather reports before casting off. Do not leave the dock area when strong winds and electrical storms are in the area or predicted to be in the area.
- Seek shelter from open water if lightning is an imminent threat.
- Tell someone of the travel plans before departing.
- Know the weight capacity of the boat. Never overload the boat.
- Never operate the boat while under the influence of drugs or alcohol.
- Look before turning the boat. The boater is obligated to maintain a course and speed unless it is safe to alter course and speed. Look before turning.
- Operators must read and understand all operating manuals supplied with the boat before operation.
- Whenever planning an outing, make sure that at least one passenger is familiar with the operation and safety aspects of the boat in case of emergency.
- Passengers should never sit in front of the operator; always avoid obstructing the operator's view.
- Show all passengers the location of emergency equipment and explain how to use it.
- Never allow passengers to drag their feet or hands in the water, or sit on the bow, bow pulpit, railing, deck or gunwale while the engine is running.
- Never use or hold on to the boarding platform while the engine is running.
- Never stand or allow passengers to stand in the boat or sit on the transom, seat backs, engine cover or sides of the boat while the engine is running. The operator or others may be thrown from the boat.
- Children and nonswimmers must wear a life jacket at all times.
- Never leave children in the boat without adult supervision.
- Improper operation of the boat is extremely dangerous.
- Securely attach the engine emergency stop switch lanyard around your leg or to a part of your clothing such as a belt loop, when operating the boat. Instruct others on how to start the boat if you as an operator are thrown overboard. Consider having an extra lanyard readily available on board since the system cannot be overridden without the lanyard that is on the person who is now overboard.
- Operate slowly in congested areas such as marinas and mooring areas.

- The bow may be slippery. Do not go forward while the engine is running.
- Slow down when crossing waves or wake in order to minimize the impact on passengers and the boat.
- Never replace the boat's marine parts with automotive parts (if applicable).
- Drain the ballast tanks on a fully ballasted boat if the engine is going to be shut down for more than 5 minutes. For more details, see *Stopping* on page 10-13.
- Never remove or modify any components of the fuel system. Always have qualified personnel perform fuel system maintenance. Tampering with fuel components may cause a hazardous condition.
- Avoid contact with engine exhaust gases—engine exhaust contains carbon monoxide.
- Never operate the engine in a confined space.
- Never go under the boat cover with the engine running or shortly after the engine has been running.
- Allow adequate ventilation with fresh air before entering any enclosed areas.
- Watch for other boats, swimmers and obstructions in the water. Stay away from other boats and personal watercraft (PWCs).
- Never swim near a boat when the engine is running. Even if the boat is in the NEUTRAL position, the propeller may still be turning and carbon monoxide may be present.
- Never dive from the boat without being absolutely sure of the depth of the water; severe injury or death may occur from striking the bottom or submerged objects.
- Never wrap ski lines or mooring lines around any body part. You could become entangled in the line if you fall overboard while the boat is moving.
- Keep track of ski lines and dock lines so they do not become entangled in the propeller.
- Have an experienced operator at the helm and always have at least three people present for safe towing—one to drive, one to observe, and one to ski or ride.

TOW BOAT SAFETY

Avoid an incident by being completely knowledgeable about your boat, its operation, the additional equipment you use, and the waterway you are using, and learn to recognize potentially hazardous situations. Maintain control of your boat at all times. Keep a sound mind during an emergency and always think safety. Use caution and common sense when operating your boat. Don't take unnecessary chances!

Likewise, persons being towed must know the signals, maintain situational awareness of their surroundings and practice safe starting, boarding, skiing and stopping practices. No matter your ability, the enjoyment of towed water sports can quickly turn into an emergency situation if the precautions are not observed.

Failure to follow and adhere to warnings may result in severe injury or death to you and/or others.

WATER SPORTS SAFETY CODE

Before you get in the water: Skiing or riding instruction is recommended before use. Instruction will teach general safety guidelines and proper skiing or riding techniques, which may reduce your risk of injury. For more information on skiing or riding schools, contact your dealer, Association or local ski club.

- Know the federal, state and local laws that apply to your area.
- If you are not familiar with a waterway, ask someone who is knowledgeable to tell you about any hidden dangers or things to avoid.
- Whether you plan to be in a watercraft or skiing/riding behind one, it is important you are wearing a properly fitted life jacket (PFD) approved by your country's agency, United States Coast Guard (USCG), International Organization for Standardization (ISO), etc.
- Inspect all equipment prior to each use: check bindings, fins, tube, attachment, tow rope and flotation device. Do not use if damaged.

Watercraft safety: A knowledgeable and responsible driver along with a separate observer is the most important safety device on any watercraft.

- Never operate a watercraft, ski or ride under the influence of alcohol or drugs.
- Only use water ballast and people for additional weight.
- Never exceed the passenger or weight limitations of the watercraft.
- Never allow passengers to hang outside the watercraft or towed device or sit on the gunwales or anywhere outside of the normal seating area.
- Never allow water to overflow the bow or gunwales of the watercraft.
- Uneven weight distribution or additional weight may affect the handling of the watercraft.

Carbon monoxide: The exhaust from the engine on a watercraft contains carbon monoxide (CO), which is a colorless, odorless and poisonous gas. Excessive exposure to CO can cause severe injury or death. Follow this advice to avoid injury.

- Never "Platform Drag" by holding onto the boarding platform or being dragged directly behind the watercraft. This is where CO will be.
- Do not sit on the watercraft transom or boarding platform while the engine is running.

Section 3

- Make sure the engine is properly tuned and running well. An improperly tuned engine produces excessive exhaust and CO.
- If you smell engine exhaust do not stay in that position.
- Go to the USCG's website (www.uscgboating.org) for more information on how to help protect yourself and others from the dangers of CO.

Tow ropes: Tow ropes come in different lengths and strengths for different activities. Make sure any rope you are using is suited for that activity and that it is in good condition.

- Never use a rope that is frayed, knotted, unraveling or discolored from use or being left in the sun. If a rope breaks while in use, it can recoil at the skier/rider being towed or into the watercraft where it might strike passengers. Replace tow ropes with any sign of damage.
- Never use a tow rope with elastic or bungee material to pull skiers or riders
- Rope should be attached to the watercraft in an approved fashion with hardware designed for towing. Refer to your watercraft manual for instructions on proper tow rope attachment.
- Always keep people and tow ropes away from the propeller, even when idling.
- If a tow rope should become entangled in a propeller, shut off the engine, remove the key and secure it in a safe location before retrieving the rope.
- Tow ropes should be neatly stowed in the boat when not in use.

Preparing to ski or ride: Always have a person other than the driver act as an observer to look out for the skier/rider.

- Be sure the driver is aware of the experience and ability level of the skier/rider.
- The driver, observer and skier/rider need to agree on hand signals before skiing or riding. Signals should include READY, STOP, SPEED UP and SLOW DOWN.
- Start the engine only after making sure that no one in the water is near the propeller.
- **Turn off the engine when people are getting into or out of the watercraft, or in the water near the watercraft.**
- Always make sure the tow rope is not wrapped around anyone's hands, arms, legs or other parts of the body.
- Start the watercraft and move slowly to remove slack until the tow rope is tight.
- When the skier/rider signals READY (Hit It) and there is no traffic ahead, take off in a straight line. Adjust the speed according to the signals given by the skier/rider.

Skiing or riding: The watercraft and skier/rider should always maintain a sufficient distance from obstacles so a skier/rider falling or coasting and/or watercraft will not encounter any obstacle.

- Do not use in shallow water or near shore, docks, pilings, swimmers, other watercraft or any other obstacles.
- Use only on water.
- Never attempt land or dock starts or stops. This will increase your risk of injury or death.
- Always wear a properly fitted life jacket approved by your country's agency, USCG, ISO, etc. Consider investing in specialized ski clothing and a competition life jacket for added safety.
- The faster you ski or ride, the greater your risk of injury. The skier/ rider should be towed at an appropriate speed for his or her ability level.
- Never make sharp turns that may cause a slingshot effect on the skier/ rider's speed.

Fallen skier or rider: Falling during water sports is commonplace and injuries from a variety of causes can occur.

- If the skier/ rider does not immediately indicate that they are "OK", assume that they need assistance.
- Circle a fallen skier/ rider slowly to return the tow rope handle or pick up the fallen skier/ rider.
- **Turn off the engine** when near a fallen skier/ rider.
- Always keep the fallen skier/ rider in view and on the driver's side of the watercraft
- Display a red or orange skier-down flag to alert other vessels that a skier/ rider is down if required by the state in which you are operating.

The warnings and practices in the Water Sports Safety Code represent common risks encountered by users. The code does not cover all instances of risk or danger. Please use common sense and good judgment. These concepts are explored in greater depth in the pages that follow.

WATER SPORT AND TOWING SAFETY

Boat operators, skiers and boarders must all be aware of current boating and water sport rules and pay constant attention to safe operating procedures and skiing practices at all times. If skiing or boarding is a new sport to you, seek certified training before starting. Be sure to thoroughly read all information provided by the water sport equipment manufacturer.

Always remember that the majority of water sports injuries are the result of impacts with other objects. Know the area you are boating in.

Always maintain clear vision where you are going and be aware of what is going on around you. Constant vigilance will go a long way toward preventing accidents. Skiers, boarders and other water sports participants must always wear a USCG-approved life jacket. It's the law!

Platform Dragging

Read, understand and be familiar with the information contained on warning labels on the boat and on the water sports equipment used, and adhere to the safe operation practices on them. The USCG issued a SAFETY ALERT on August 28, 2001 that covers some of the issues of improper use of the boarding platform.



Carbon Monoxide / Propeller Injury Accident: “Platform Dragging” places the individual in a position directly exposed to the carbon monoxide in the engine’s exhaust. It is the equivalent of dragging directly behind the bumper of a truck on roller skates. This may result in a loss of coherent responses and even death. In addition, “Platform Dragging” dangerously exposes the individual to a possible propeller injury.

Propeller Strikes

Recreational boating has become even more popular in the last several years, and the types of injuries that can occur from unsafe boating have increased. These injuries include exposure to carbon monoxide, rotating parts or hot engine components. Injuries such as these are dangerous and add to the belief that boating can be unsafe. Knowledge and taking precautions before boating can increase safety on the water and provide a lifetime of boating enjoyment.

Boat manufacturers and safe boating agencies strive to keep boating and water sports as safe as possible by providing guidelines. Still, it is the boating enthusiast’s responsibility to follow these guidelines. The responsibility of the operators, participants or bystanders is to protect themselves from danger by observing warnings and keeping all safety equipment in place and ready to use.

Contact with rotating propellers is one of the most dangerous hazards, which occurs from negligence of operators, passengers and bystanders. A propeller is designed to travel in the water and rotates at a speed that can cause death if it comes into contact with a human. Severing, deep lacerations, blood loss, trauma and exposure to microorganisms in the water that enter the bloodstream can result in death or serious injury.

STOP PROPELLER STRIKES by always using caution and:

- OBSERVING all warnings and keeping all safety equipment in use and in place.
- STOPPING the engine when swimmers are near the boat and in the water.
- MAKING SURE all passengers are seated on a horizontal seat cushion whenever the boat is in gear or moving.
- NOT ALLOWING passengers to enter the water when the engine is running.
- USING the boat’s emergency stop switch at all times.
- MAKING SURE all operators are properly trained and qualified to operate the boat.

- KEEPING your eyes on your path as well as the water sports participant.
- NOT ALLOWING water sports participants to be in the path of other boaters.
- STAYING CLEAR of swimmers and other water sports participants by maintaining visual surveillance.
- KNOWING the correct water sports hand signals.
- NOT ALLOWING children under 11 years of age to occupy the open bow area unless accompanied by an adult.
- USING an observer during water sports activities.

Water Sports Responsibility Code

BE AWARE

There are risks in boating and water sports that good judgment and personal awareness can help reduce. To increase your enjoyment of water sports, follow the ten elements of the Code.

In water sports, it is your responsibility to:

- ALWAYS familiarize yourself with applicable laws, waterways and inherent risks.
- ALWAYS have a capable observer in addition to driver, and agreed on hand signals.
- ALWAYS wear a properly fitted life jacket approved by your country's agency.
- ALWAYS read user's manual and inspect equipment before use.
- ALWAYS ski and ride under control, at proper speeds, and within your limits.
- ALWAYS turn ignition off when anyone is near watercraft power drive unit.
- ALWAYS stay clear of engine exhaust to avoid carbon monoxide poisoning.
- NEVER "Platform Drag" or touch swim platform while the engine is running.
- NEVER ski or ride near swimmers, shallow water, other boats or obstacles.
- NEVER operate watercraft, ski or ride under the influence of alcohol.

Know Water Sports Hand Signals

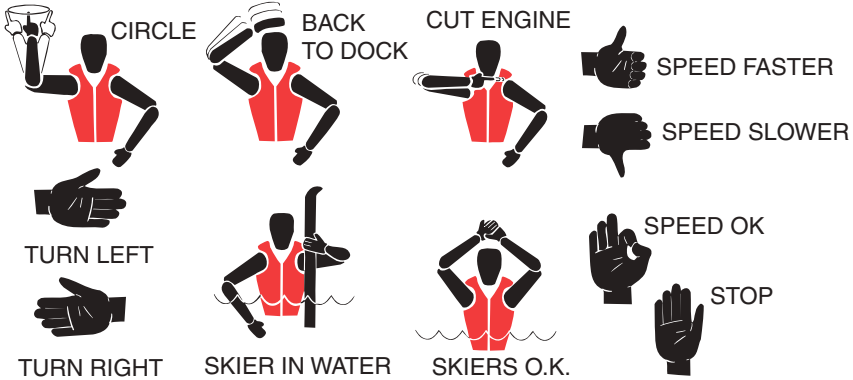

KC-0016C-A

Falling Tips for Water Sports

- Sudden falls happen. DO NOT put any body parts (arms, legs, head) inside the rope handle.
- Tighten your life jacket straps for a snug fit.
- Let the handle go as soon as you sense you're about to fall. Falling is better than dragging.
- Roll with it. Bow your head, bend your knees, tuck in your arms and make like a beach ball.
- Signal the observer to let them know you are OK after a fall.
- After you fall, lift your ski or board above the water so other boaters can see you.
- When learning advanced maneuvers, it's best to seek training from a professional.
- A little advice will cut down on falls, shorten your learning time and reduce the chances of an injury.

Driver - Best Practices

BE AWARE

Many watersports boats are designed with hulls best suited for calmer conditions. It's best to avoid large bodies of water where rough chop is a risk.

The boat driver plays a critical role in the enjoyment and safety of all towed water sports participants. Do not allow inexperienced drivers to drive for skiers/riders without thorough instruction and training. We encourage all boat operators to take a boater's education course. See your state's boating authority for available courses or other operating requirements.

- Wait for a clear boat path ahead of you before accelerating.
- Make sure to use the proper rope for the sport. A rope designed to pull a skier is not the recommended rope for towing a tube.
- If skiing, boarding or tubing with more than one person, make sure all tow ropes are the same length.
- Keep a 100-foot buffer zone on all sides of the boat and stay in water that is safe for the skier/rider and draft of your boat.
- Make sure the tow line unwinds smoothly without getting snagged on anyone or anything.
- Idle forward to make the rope tight.
- Accelerate only when the tow rope is completely tight and the skier/rider has given the "hit it" signal. The words GO and NO can be easily confused with wind, water and engine noise all around you. It is best to find another signal other than GO to tell the driver to power up. HIT IT or BOAT DRIVER are better options.
- Always approach fallen skiers/riders in the water from the driver's side, so the driver does not lose sight of them.
- **TURN OFF ENGINE** when a skier/rider is near the boat, rather than running the engine in NEUTRAL. An accidental bump of the throttle when the engine is running could put the boat in gear.
- DO NOT let the tow rope slip under the boat and become tangled in the propeller. It is a good practice to keep a knife on board should this situation occur.
- Always pay attention to the water ahead, the traffic around you and your onboard observer. Your observer must always keep you aware of the skier/rider status.
- DO NOT whip skiers or riders near shores, docks, other boats or fixed obstructions; they can glide 100 feet or more after they let go of the rope.



DANGER

Entanglement Hazard: Accelerating before the rope is 100% tight, and the skier/rider gives the "HIT IT" signal, can result in skiers/riders becoming entangled in the rope. Entanglement in the rope can result in severe injuries or death.

Section 3

Driving Pattern

Drivers who want to minimize the rough water for the skier/rider should utilize a dog-bone pattern when driving. A dog-bone pattern follows the same path from one end of the course to the other, with tight controlled turns at each end. Use this pattern where few other boats are operating. In areas where many boats are operating, use a large racetrack pattern.

Check with local lake laws before you drive any pattern. Some areas require drivers to drive skiers/riders in preset patterns.

Use in light traffic areas

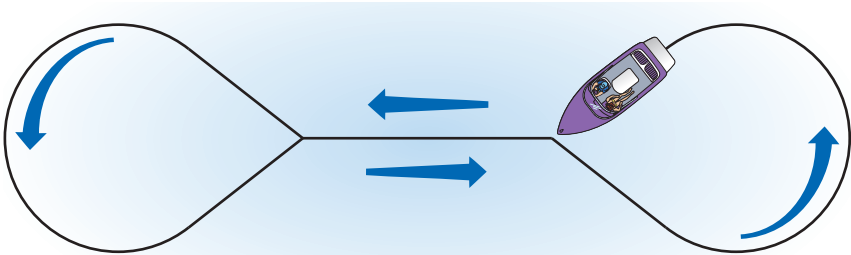

KC-0317C-A

Use in light traffic areas

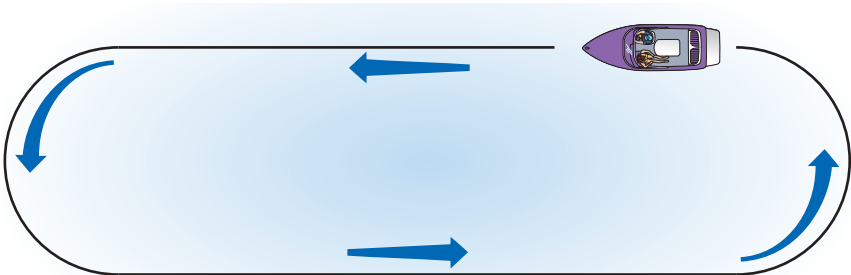

KC-0358

Driver Position

1. Always keep your right hand on the throttle, even if you have a speed control device engaged, so you have immediate control of the throttle.
2. Always keep your left hand on the steering wheel, preferably at the 10 o'clock position. If you take it off, the light-pressure steering you enjoy becomes sensitive to even small torques on the rudder. This could cause the boat to take unexpected turns.
3. Sit firmly in the driver's seat, never on the seat backs, gunwale, sun deck or anywhere else where one big wake could eject you from the craft.
4. Alternate your eyes between the mirror, to watch the skier/rider, and your boat path. Watching your wake in the mirror can help ensure a straight boat path. Continually watch all directions for boats or other obstructions.
5. Monitor the gauges, including water temperature and oil pressure, to make sure the engine is running smoothly. Keep the fuel gauge over 1/4 tank to prevent sloshing gas giving a false reading.
6. It is the driver's responsibility to keep all passengers seated in a proper seat while the boat is underway. DO NOT allow passengers to sit on the seat backs, gunwale, sun deck or motor box. Sitting in these positions will often encourage a visit from your local water patrol, and may result in a ticket. DO NOT allow small children to sit in the bow area when the boat is underway without adult supervision.

WATER SPORT TIPS

These tips are designed to help speed your learning, while ensuring safety. Practice, training from a professional and advice from experienced boaters are the best tools for learning safety when it comes to water sports.

For recreational boats, water sports include any activity performed in the water such as skiing, kneeboarding, wakeboarding, wakesurfing, hydrofoiling, swimming, diving, snorkeling or gliding using a device that may be pulled by a boat. Boats equipped with a ski pylon or tower tow point can be used for most water sports in accordance with the capacity limits listed on the label.

Inflatables, also known as tubes, have some unique safety considerations and require the use of both stern eye strong points in combination with a proper tube harness and tow rope; see *Inflatables/Tube Tips* in this section for more information. Parasails and kites require specialized equipment and training and should never be used with a recreational boat.

REMEMBER: It's important to follow the manufacturer's recommendations for the intended use of the water sport equipment.

REMEMBER: It is illegal in many states to participate in towed water sports without a USCG-approved life jacket.

BE AWARE

You are responsible for your own wakes. Be considerate of other boaters, especially small fishing boats, canoes and kayaks that can overturn easily. Also, be aware of your wakes in relation to swimmers, docks and boats tied to docks.

Water Skiing

A rush of acceleration as you cut across the wakes will cause you to go faster than the speed of the boat. You can slice it up in open water, or navigate the slalom course if you want to track your progress in the competitive side of the sport.

When water skiing, keep the following tips in mind:

- **Speed:** Faster than wakeboarding, but still only requires about 20-24 mph on combo skis or a shaped slalom ski. More advanced slalom skiers can go anywhere from the mid 20s to a top speed of 36 mph.
- **Line length:** 75 feet is a good place to start, but adjust it accordingly to find the mellowest, most ski-friendly part of the wake on your boat. Serious skiers obsess over taking that line length ever shorter, while still attempting to reach the buoys in a slalom course.
- **Driving tips:** Guide the boat straight, since today's towboats handle almost like on a rail. Speed controls also promote consistent speeds. Follow the same path back and forth to stay on the smoothest water. Drivers should hold speed commensurate with the level of the skier.
- **Ballast:** Equal weight means equal wakes. If you're a 175-pound driver, make sure you have a balanced load on the opposite side (a 125-pound passenger with 50 pounds of ballast, etc.). Lighten the load in the back of the boat to prevent the hull from digging in, creating larger-than-intended wakes.

Deep water start: Go into a crouched position, with combo skis or slalom ski underneath you and legs very bent. Point the ski tip out of the water toward the boat. Don't worry if a slalom ski isn't straight up and down. Keep part of it touching the tow rope, then as the boat starts, it will correct itself and center along the tow-rope line.

With arms straight, and knees bent, let the boat pull you up and onto the water, rather than pushing on the ski or leaning back against the pull.

What to do next: After the driver and the skiers have their fill of casual skiing in open water, try driving straight down the middle of a slalom course as the skier swings back and forth around special turn buoys. It's addictive.

For more detailed and comprehensive instruction and additional ideas, visit: Basic Skills Challenge series: <http://www.usawaterski.org/basicskillschallengeseries.htm>. Instructional articles can be viewed at: <http://www.usawaterski.org/pages/instruction.html>.

Wakeboarding

Wakeboarding is like surfing, snowboarding, and flying all rolled into one—only you're being pulled behind a boat at full throttle! With every carve, jump, and trick, you're skimming the water all while soaking up the sun and good vibes.

When wakeboarding, don't forget your:

- **Speed:** For the first time with kids, 12 mph; around 18-24 mph for adults. Accelerate slightly if you need to adjust the wake so that it has a clean edge (not foamy) near the front foot of the rider.
- **Line length:** 65 feet is a good length for beginners, who will appreciate being back where the wakes are softer and farther apart, though many riders start at around 50 feet (the shorter rope length can make it easier to get up). More experienced riders may want to be at about 75-80 feet, where the wakes are more defined and wider.
- **Driving tips:** Drive straight to establish consistent wakes for the rider to enjoy. The observer should always be facing the rider so the driver can focus on that path and the speed. Slow but steady acceleration is best for wakeboarding.
- **Ballast:** Factory-installed systems allow you to safely add hundreds of pounds of water weight in ideal spots on the boat and shape the wakes for each rider's preference. Weigh down the stern equal to the bow to best maintain your boat's handling, taking into account passenger seating. A water-filled ballast bag is the best way to add weight. **DO NOT USE** ballast that sinks, such as a bucket of concrete, or lead.



WARNING *Overloading Hazard: Empty the ballast system before trailering your boat. The extra weight of ballast water may overload the capacity of your trailer and cause an unsafe condition that can lead to an accident, injury or death.*

Always stay within Coast Guard recommendations for your boat's weight capacity. When adding aftermarket ballast systems, maximum boat load capacity **MUST BE** reduced. Reduce passengers and/or equipment by the additional weight of water intended to be taken into the ballast system.

To help prevent the spread of invasive species, DO NOT transport lake water in your ballast system from lake to lake.

What a wakeboarder does first: Keep knees bent, arms straight, shoulders back and both feet under you on the board (this will result in the long axis of the board being perpendicular to the tow rope). Look straight ahead (not at your feet) and keep the handle low at your front hip as you let the boat pull you out of the water. As you rise onto the water, the board will automatically rotate to be in line with the tow rope. Now you can stand up, with knees still bent slightly, keeping your weight equal over both feet. Let your upper body stay motionless, with shoulders level and perpendicular to the tow rope.

Section 3

What to do next: Cross the wake slowly, but staying on edge to get a feel of how to use the wake as a launch ramp for larger moves. Jump the wake to build your confidence. (It is often helpful to shorten the rope when learning this, as the wakes are narrower.)

For additional information visit: <http://www.thewwa.com/about/> or <http://www.usawaterski.org/BasicSkills/LearnToWakeboard.pdf>

Wakeskating

While wakeboarding is similar to snow-boarding in that the rider's feet are physically strapped to the board, wakeskating brings the spirit of skateboarding to the water (sans wheels). Unleashing an arsenal of skate moves, you're never tied down.

When wakeskating, keep the following tips in mind:

- **Speed:** Ease off a little from wakeboarding speeds to keep the speedometer in the mid-teens.
- **Line length:** This can vary, but start with 65 feet to see how it works for you.
- **Driving tips:** Again, like wakeboarding, follow a straight path for consistent wakes. What a wakeskater does first: Put the board under your feet under the water; then pretend you're sitting down with bent knees. As the boat starts forward, the board will rise onto the water as you stay crouched to set your balance. Stand up, with knees still slightly bent, eyes ahead and your hands near your forward hip. Riders often wear tennis shoes or wakeskate shoes for better traction on the board.

What to do next: Try a world of moves, anything from an “ollie” to a “pop shuvit” to a “kick flip” to riding rails. New maneuvers are constantly being invented in this new sport.

Helmets: Because a wakeskate is not attached to your feet, it can impact your head or other body parts in a fall. Helmets are strongly recommended when wakeskating.

Inflatables

Towed inflatables commonly called “tubes,” come in all shapes and sizes now, from traditional doughnuts to rocket-ship cones. It's all so you and your friends can enjoy a new thrill or a relaxing ride. Regardless of the type of tube, they all produce tremendous stress on the tow point and rope, far greater than devices like water skis.

When tubing, keep the following tips in mind:

- **Speed:** 8 mph for small children; 20 mph is about the limit for adults. Settle in at 15-18 mph for a safe yet adrenaline-pumping ride. Don't forget your life jacket – falls can take your breath away on a tube.

- **Line length:** 60 feet can give you the best of all worlds, close enough to the boat for a sense of control yet far enough for the feeling of freedom on the rampy wakes. Be sure to use a specifically designed tube rope made to support the weight and drag of a tube and the number of people riding the tube.
- **Driving tips:** A leisurely “S” shape gives tubers who can't really control their own motion the chance to swing across the wakes and travel side to side without the need for wild spins and hairpin turns. Slowing the boat down when approaching large wakes can keep inexperienced riders from getting thrown from the tube when they are not ready for it.
- Follow the general water sports safety guidelines in this section for operating the engine, using life jackets, using a spotter, guarding against rope entanglement, reviewing equipment condition before use, understanding rider skill levels, and abiding by regulations for distances to other boats, docks and shore lines.
- Do NOT attempt to intentionally cause a tube rider to fall and use extreme caution with multiple riders to prevent slamming riders together.
- Do NOT use ski tow pylons or tower tow points for tubes. Use both port and starboard stern eye strong points with a tube tow harness to attach the tube tow rope. Add a floating ball to the tow rope to keep the rope on top of the water and improve performance.
- Check the tube air pressure often and maintain the manufacturer's recommended level as listed on the device. Pressure levels can change rapidly from sun and shade; too low and it creates additional drag, too high and it may cause tube failure.
- Tow only one tube at a time.
- Read and understand the user's manual for the tube; instruct children on the Do's and Don'ts.

What a tuber does first: Start on a big family-friendly traditional shape, introducing the kids and friends to tubing. Lie on your stomach to plant yourself firmly on the tube, and hang on to the handles.

What to do next: Grab a new shape with extra-big handles to hang onto; then find a lot of open water, turn some bigger “S” turns and “let loose,” without letting go, of course.

REMEMBER: It's important to follow the manufacturer's recommendations for inflation, as well as the intended use of the water sport equipment.



DANGER

Entanglement Hazard: Never accelerate the towboat or watercraft unless the tow rope is completely tight. Failure to follow this warning can result in rope burns, loss of limbs or even death.

Barefooting

There's nothing like the sensation of "walking" on water. Since your feet have less surface area than a ski or board, so you'll need to go faster and be more cautious. Because of the speeds involved, the extra protection of neoprene ski vest and shorts in addition to a competition-grade life jacket are highly recommended.

When barefooting, keep the following tips in mind:

- **Speed:** A general guideline for speed is the barefooter's weight divided by 10 then add 20. A 150-pound person would go approximately 35 mph. Those faster speeds, usually ranging from 30 to 45 mph, require extra caution, especially with knowing how to fall and looking out for debris in the water.
- **Line length:** 100 feet, use the length to get back to the calmer water.
- **Driving tips:** It takes finesse to manage just the right gradual (but not too strong) acceleration to get a barefooter out of the water, then a steady throttling-up to climb to footing speed.

What a barefooter does first, three ways to get going:

1. Start on a kneeboard or a wakeskate in a forward-seating position and slowly come up to speed to plane while setting your feet in the water slowly.
2. Step off a single slalom ski.
3. If you really want to shorten the learning curve, find an experienced instructor with a boom attached to the boat.

To stay on the water, have your feet shoulder-width apart and your knees bent at a right angle. Position your feet forward of your body; some experimentation of feet position will be necessary before you find the "sweet spot."

What to do next: Don't just stand still, move! Learning to shift your weight and the handle leads to fun maneuvers such as one-foot wake crossings, tumble-turns and jumps.

For additional information visit:

<http://www.usawaterski.org/pages/divisions/barefoot/main.htm> and

<http://www.usawaterski.org/BasicSkills/LearnToBarefoot.pdf>

Wakesurfing

Water lovers with ocean envy are getting hooked on wakesurfing, creating their own mini waves with their boats.

When wakesurfing, keep these tips in mind:

- **Speed:** Relatively slow, about 10 mph to churn up surfable wakes without outrunning the surfer.

- **Line length:** Start with 10-15 feet behind the platform to put you onto a beefy section of the wake, but far enough back to get you as clear as possible from the platform of the boat. Make sure to use a rope designed for wakesurfing. Wakesurf ropes offer a thick braid that is easier to pull yourself into the proper spot on the wake.



CAUTION *Entanglement Hazard: DO NOT use the thin, non-stretch ropes intended for wakeboarding. Thin ropes can be dangerous when you are pulling yourself into the wake.*

- **Driving tips:** Adjust ballast and passengers to favor the stern, but not so much to risk taking on water. Keep straight and steady with no sudden slowdowns. A slight turn toward the side the rider is on can help shape the wakes better for surfing on some boats. Each boat is different here, so experiment with different things to make the wakes as good as possible.

REMEMBER: Never use the gunwales for seating. Doing this is dangerous and most water patrols will ticket you for this behavior.

- **Ballast:** Factory-installed systems allow you to safely add hundreds of pounds of water weight in ideal spots on the boat and shape the wakes for each rider's preference. Weigh down the stern equal to the bow to best maintain your boat's handling, taking into account passenger seating. A water-filled ballast bag is the best way to add weight. DO NOT USE ballast that sinks, such as a bucket of concrete, or lead.



WARNING *Overloading Hazard: Empty the ballast system before trailering your boat. The extra weight of ballast water may overload the capacity of your trailer and cause an unsafe condition that can lead to an accident, injury or death.*

Always stay within Coast Guard recommendations for your boat's weight capacity. When adding aftermarket ballast systems, maximum boat load capacity MUST BE reduced. Reduce passengers and/or equipment by the additional weight of water intended to be taken into the ballast system.

To help prevent the spread of invasive species, DO NOT transport lake water in your ballast system or trailer from lake to lake.

What a wakesurfer does first: Figure out which wake, the left or the right, offers the most natural riding for you and the best definition. Most riders ride "toes in" to the wake. Keep your knees very bent, and your rope very low as you start. Ride into the wall on the wake until you feel the wake push you, without any pull on the rope. At that point, the rider can throw the rope back into the boat, and surf with total freedom.

What to do next: Create your own fusion of skate, wakeboard and surf moves.



Entanglement Hazard: Surfers will often experiment with rope length to find the sweet spot on the wake. Never coil excess rope around your hands or arms while wakesurfing. Always throw the rope away from your body in a fall. A fall into a coiled rope can cause severe injury to any extremity.

Wake Responsibly

1. Stay at least 150 feet away from the shoreline, docks or other structures.
2. Keep music at reasonable levels. Sound travels well over water. If it's loud enough to hear at 80 feet back, it is likely loud enough for homeowners to hear, too.
3. Minimize repetitive passes on any one portion of shoreline. Once you've run the same line for a while, move on to another area.

Remember, you are responsible for your own wake.

SAFETY DECALS AND STATEMENTS

SAFETY DECALS

The boat is affixed with various hazard and safety labels at the time of manufacture. These labels appear in specific locations on the boat and on equipment where safety is of particular concern. All operators of the boat must read and understand all hazard and safety labels and advise all passengers on the safety concerns and proper practices. Hazard and safety labels must remain legible. If the operator suspects a label is missing or damaged they should contact the dealer for replacement.

PART NUMBER	LOCATION
301951	Bow center seat base
301776	Cooler lid
301943	Inside port tower base
301932	Inside stbd rear hatch
301944	Inside stbd tower base
301948	Port observer seat walk thru panel
304086	Port observer seat walk thru panel
302551	Port observer seat walk thru panel
322264	Port observer seat walk thru panel
304124	Port observer seat walk thru panel
302384	Port observer seat walk thru panel

PART NUMBER	LOCATION
302385	Port observer seat walk thru panel
302386	Port observer seat walk thru panel
302387	Port observer seat walk thru panel
302388	Port observer seat walk thru panel
302389	Port observer seat walk thru panel
302974	Port observer seat walk thru panel
301942	Port rear tower center section
302423	Port rear transom
304087	Stbd inside windshield
301955	Stbd rear tower center section
302390	Stbd rear transom

Caution Check List

For maximum enjoyment and safety, check each of the items BEFORE you start your engine:

- DRAIN PLUG (Securely in place)**
- LIFE SAVING DEVICES (One for every person on board?)**
- STEERING SYSTEM (Working smoothly and properly?)**
- FUEL SYSTEM (Adequate fuel? Leaks? Fumes?)**
- BATTERY (Fully charged? Cable terminals clean and tight?)**
- ENGINE (In neutral?)**
- CAPACITY PLATE (Are you overloaded or overpowered?)**
- WEATHER CONDITIONS (Safe to go out?)**
- ELECTRICAL CONDITIONS (Lights, horn, pump, etc.?)**
- EMERGENCY GEAR (Fire extinguisher, bailer, paddle, anchor & line, signaling device, tool kit, etc.)**
- INSPECT BILGE PUMP (Will water exit boat and is pump free of debris?)**

⚠ DANGER



Carbon monoxide (CO) can cause brain damage or death.
 Engine and generator exhaust contains odorless and colorless carbon monoxide gas.
 Carbon monoxide will be around the back of the boat when engines or generators are running.
 Move to fresh air, if you feel nausea, headache, dizziness, or drowsiness.

U31285-01

302423

⚠ WARNING

ROTATING PROPELLER MAY CAUSE SERIOUS INJURY OR DEATH.
 SHUT OFF ENGINE WHEN NEAR PERSONS IN THE WATER.

301948

⚠ WARNING

GASOLINE VAPORS CAN EXPLODE.
 BEFORE STARTING ENGINE OPERATE BLOWER FOR 4 MINUTES AND CHECK ENGINE COMPARTMENT BILGE FOR GASOLINE VAPORS.

304087

NOTICE

ALL FASTENERS ATTACHING SPEAKERS, RACKS, AND LIGHTS SHOULD BE CHECKED FOR SNUGNESS DAILY BEFORE USING YOUR BOAT. ALL OTHER FASTENERS SHOULD BE CHECKED EVERY 10 HOURS OF USE.

301942

MEETS U.S. EPA EVAP STANDARDS USING CERTIFIED COMPONENTS
 FINELINE IND., MERCED, CA

304086

WARNING!

AVOID SERIOUS INJURY OR DEATH. UNEXPECTED SEAT ROTATION MAY CAUSE EJECTION OF OCCUPANT. LOCK SWIVEL WHEN SPEED EXCEEDS 5 MPH.

302551

⚠ WARNING

DO NOT TOW ANY TYPE OF INFLATABLE, MULTIPLE PERSONS, OR A KITE DEVICE WITH YOUR TOWER. THIS TOWER WAS DESIGNED FOR TOWING A SINGLE WAKE BOARDER OR WAKE SURFER.

301943

EMISSIONS CONTROL SYSTEM INFORMATION

MEETS U.S. EPA EVAP STANDARDS USING CERTIFIED COMPONENTS AND MEETS 2025 MY CALIFORNIA EVAP EMISSIONS REGULATIONS FOR SPARK-IGNITION MARINE WATERCRAFT

MANUFACTURER: CENTURION & SUPREME BOATS

CALIFORNIA EVAP FAMILY: PCSBPVSSL001

EMISSION CONTROL SYSTEM: CARBON CANISTER, PLASTIC TANK

322264

DANGER

PINCH POINT

301776

CNTRN-0058D-A

⚠ WARNING

DO NOT USE YOUR TOWER TO SECURE YOUR BOAT TO A DOCK OR PIER OR TO TOW ANOTHER BOAT.

301944

NOTICE

DO NOT TRANSPORT BOAT WITH TOWER IN DOWN POSITION. STATIC STORAGE ONLY.

301955

WARNING

LEAKING FUEL IS A FIRE AND EXPLOSION HAZARD. INSPECT SYSTEM REGULARLY. EXAMINE FUEL TANKS FOR LEAKS OR CORROSION AT LEAST ANNUALLY.

301932

**BOW SECTION LIMIT
2 PERSONS OR 370 LBS.**
78-181

301951

⚠ WARNING

Failure to follow these warnings could cause serious injury or death



ONLY USE THIS TOW PYLON FOR WATERSKIING, BOARDING, OR RECREATIONAL TOWABLES.

Do not use this tow pylon for parasailing, kite flying, pyramids, group pulls, barefoot/teaching booms, pylon extensions or towing other boats.

DO NOT SIT IN THE PATH OF THE TOW LINE when it is in use.

304124

⚠ WARNING

Failure to follow these warnings could cause serious injury or death

Lock the tower in place and secure all hardware before and during use.

DO NOT TOW MORE THAN 1 PERSON OR 350 POUNDS at one time from this tow tower.

Only use this tow tower for waterskiing, or boarding.

Do not use this tow tower for parasailing, kite flying, pyramids, group pulls, or towing other boats.

Do not climb on, sit on, stand on, jump off of or dive off the tow tower.

302384

⚠ WARNING

A wide variety of components used on this vessel contain or emit chemicals known to the State of California to cause cancer and birth defects and other reproductive harm.

EXAMPLES INCLUDE:

- Engine and generator exhaust
- Engine and generator fuel, and other liquids such as coolants and oil, especially used motor oil
- Cooking fuels
- Cleaners, paints, and substances used for vessel repair
- Waste materials that result from wear of vessel components
- Lead from battery terminals and from other sources such as ballast or fishing sinkers

TO AVOID HARM:

- Keep away from engine, generator, and cooking fuel exhaust fumes
- Wash areas thoroughly with soap and water after handling the substances above

UB096

302974

⚠ WARNING

Failure to follow these warnings could cause serious injury or death



REMAIN PROPERLY SEATED AND HOLD ON to available handrails while boat is moving to avoid falling overboard or being ejected from the boat. Do not sit on gunwales or deck edges.

DO NOT OVERLOAD THE BOAT. Occupants and gear must be evenly distributed on both sides of the boat to avoid poor handling, sudden loss of control, swamping and/or capsizing.

Refer to and obey your specific model's designated occupant positions depicted in the Owner's Manual.

KEEP LIMBS AND BODY CLEAR OF ALL TOW LINES at all times to avoid entanglement and other types of injuries.

USCG APPROVED LIFE JACKETS should be on board for all passengers and all towed participants.

302386

CNTRN-0059E-A

Section 3

WARNING

Failure to follow these warnings could cause serious injury or death



REMAIN PROPERLY SEATED AND HOLD ON TO AVAILABLE HANDRAILS while boat is moving to avoid falling overboard or being ejected from the boat. Do not sit on gunwales or deck edges.

DO NOT EXCEED THE BOW CAPACITY of 2 persons or 350 pounds. Overloading the bow of the boat can cause loss of control, swamping and/or capsizing.

DO NOT OBSTRUCT OPERATOR VISIBILITY. Operators must have a clear view in front of them to avoid collisions.



USCG APPROVED LIFE JACKETS should be on board for all passengers and all towed participants.

302385

ANGER



CONTACT WITH A SPINNING PROPELLER WILL CAUSE SERIOUS INJURY OR DEATH.

Stay clear of boat and stay off swim platform while engine is running.



CARBON MONOXIDE (CO) CAN CAUSE BRAIN DAMAGE OR DEATH.

Engine exhaust contains odorless and colorless carbon monoxide gas.

Carbon monoxide will be around the back of the boat when engines or generators are running.

MOVE TO FRESH AIR if you feel nausea, headache, dizziness, or drowsiness.

302387

ANGER



CONTACT WITH A SPINNING PROPELLER WILL CAUSE SERIOUS INJURY OR DEATH.

Do not run engine while people are in the water or on the swim platform.

Do not back toward a person in the water.

302388

WARNING

Failure to follow these warnings could cause severe injury or death







- GASOLINE VAPORS CAN EXPLODE. BEFORE STARTING ENGINE:**
 - OPERATE BLOWER for 5 minutes.
 - CHECK THE ENGINE COMPARTMENT for gasoline vapors by sight and smell.
- OPERATE BLOWER to clear gasoline vapors from engine compartment when engine is at idle, while below cruising speed and after stopping engine.
- CARBON MONOXIDE (CO) CAN CAUSE BRAIN DAMAGE OR DEATH.**
 - Engine exhaust contains odorless and colorless carbon monoxide gas.
 - Signs of carbon monoxide poisoning include nausea, headache, dizziness, drowsiness, and lack of consciousness.
 - MOVE TO FRESH AIR if anyone shows signs of carbon monoxide poisoning.
 - SEE OWNER'S MANUAL for additional information regarding carbon monoxide poisoning.
- CHECK WEATHER FORECAST BEFORE DEPARTING DOCK and heed all weather advisories.
- WEAR SAFETY LANYARD at all times while operating boat to prevent unintended boat operation.
- NEVER OPERATE WHILE UNDER THE INFLUENCE of drugs or alcohol.
- DO NOT OVERLOAD THE BOAT. ENSURE THAT WEIGHT IS PROPERLY AND EVENLY DISTRIBUTED fore and aft and on both sides of the boat to avoid gear handling, sudden loss of control, swamping and/or capsizing.
- USCG APPROVED LIFE JACKETS SHALL BE ON BOARD FOR ALL PASSENGERS AND TOWED PARTICIPANTS.
- MAKE SURE THAT ALL PASSENGERS ARE PROPERLY SEATED WHILE UNDERWAY. To avoid passengers falling overboard or being ejected from the boat, do not allow passengers to sit on seat backs, gunwales or submax deck edges while boat is moving.
- REDUCE SPEED BEFORE ATTEMPTING SUDDEN OR SHARP TURNS, AND MAINTAIN SAFE SPEEDS for water conditions and equipment at all times. Maneuverability at high speeds is limited, and sudden turns may cause loss of boat control.
- KEEP PROPER LOOKOUT and SAFE DISTANCE for the conditions at all times to avoid collisions.
- OBEY APPLICABLE NAVIGATION RULES AND BOATING LAWS.
- USE CAUTION AND PROPER LIGHTING during nighttime boating and boating in adverse weather.
- READ THE OWNER'S MANUAL AND COMPLETE THE BOATER'S PRE-OPERATION CHECKLIST prior to boat operation.

302389

ANGER



CONTACT WITH A SPINNING PROPELLER WILL CAUSE INJURY OR DEATH.

Do not enter or exit the water when the engine is running.

Do not get on the swim platform when the engine is running.

Do not swim towards the back of the boat if the engine is running.

302390

CNTRN-0060-A

SAFETY STATEMENTS

There is no substitute for sound judgment and careful practices. Improper practices or carelessness can cause burns, cuts, mutilation, asphyxiation, other bodily injury or death. This information contains general safety precautions and guidelines that must be followed to reduce risk to personal safety. Special safety precautions are listed in specific procedures. Read and understand all of the safety precautions before operation or performing repairs or maintenance.



NOTE — This safety alert symbol appears with most safety statements. It means attention, become alert, your safety is involved! Please read and abide by the message that follows the safety alert symbol.



DANGER

Indicates a hazardous situation that, if not avoided, will result in death or serious injury.



WARNING

Indicates a hazardous situation that, if not avoided, could result in death or serious injury.



CAUTION

Indicates a hazardous situation that, if not avoided, could result in minor or moderate injury.

NOTICE

Indicates a situation that can cause damage to the boat and accessories and/or the environment, or cause the equipment to operate improperly.

SAFETY PRECAUTIONS



DANGER

The safety messages that follow have **DANGER** level hazards. These safety messages describe hazardous situations that, if not avoided, will result in death or serious injury.



Training Hazard: Do not permit anyone to launch, operate or retrieve the boat without proper training.

- Read and understand this *Basic Boating and Safety Manual* and all manufacturer-supplied information before operating or servicing the boat to ensure that you follow safe operating practices and maintenance procedures.
- Safety signs and labels are additional reminders for safe operating and maintenance techniques.
- See the boat dealer for additional training.



Exhaust Hazard: Carbon monoxide (CO) is a colorless and odorless gas produced by all engines, fuel-burning appliances and any material that contains carbon and is burned. Direct or prolonged exposure to carbon monoxide will cause brain damage or death.



Electrocution Hazard: Docks and other boats nearby can carry sources of electricity. Faulty wiring or the use of damaged electrical cords and other devices not approved as “shore or marine rated” can cause the surrounding water source to become energized from electricity leakage. Never enter the water or swim in a marina.



WARNING

The safety messages that follow have **WARNING** level hazards. These safety messages describe hazardous situations that, if not avoided, could result in death or serious injury.



Fire/Explosion Hazard: Gasoline is extremely flammable and highly explosive under certain conditions.

- Compartments for fuel, flammable liquids or gases must be properly ventilated to prevent explosive vapors from accumulating. Most vapors are heavier than air. If not in a vapor-tight locker vented overboard, vapors will accumulate in the bilge, posing a fire and explosion hazard.
- Inspect fuel system for leaks at least once a year.



Fire/Explosion Hazard: Hydrogen gases produced by a lead-acid battery while it is charging, or the engine is running, can cause an explosion and/or a fire.

- **Always wear personal protective equipment when working on or around batteries.**
- **Keep the area around the battery well-ventilated.**
- **Do not smoke or bring an open flame or any other form of ignition near a battery.**
- **Do not check for a dead battery by placing a metal object between the battery posts. Sparks could cause an explosion.**
- **Do not place your head directly above a battery when making or breaking electrical connections.**
- **Always charge the battery outside of the boat.**
- **Do not use a battery booster to start the engine.**



Sever Hazard: Make sure nobody is near the propeller before starting the engine(s).

- **Do not allow swimmers to approach or use the ladder when the engine is running.**
- **The operator should walk to the stern and check the water for people near the propeller, as people in the water may not always be noticeable from the helm.**
- **Turn off the engine(s) before allowing people to board or exit the boat. The propeller may continue rotating even when the engine is idling or in NEUTRAL.**
- **Show passengers the location of the propeller and teach them to keep their distance from it at all times, even when the propeller is not in motion.**
- **Show passengers the propeller warning labels around the boat and discuss propeller dangers.**
- **Be particularly alert when boating in high-traffic areas and never operate in swimming zones.**
- **Exercise caution when operating near boats that are towing skiers and tubers.**
- **Never allow passengers to sit in areas where they could fall overboard, including the bow, gunwale, transom, seat backs, or other locations.**
- **Carefully watch children aboard the boat at all times.**
- **Instruct passengers on the rules for using the swim platform, boarding ladders and seats. If possible, instruct them to stay seated at all times while the engine is running.**



Man Overboard Hazard: Always remain seated in the boat manufacturer's designated seating arrangement, use handholds and never block the view of the boat operator while underway. The boat's bow, gunwale, transom platform and seat backs are not intended for use while underway.

- If someone falls overboard, slowly turn the boat around while keeping an eye on the victim. Ask a passenger to help monitor the victim. Always STOP THE ENGINE before rescuing a victim from the water.
- Never put the engine in REVERSE to retrieve a person from the water. Slowly circle back to the person again if necessary.



Entanglement Hazard: Rotating or moving parts can entangle or sever body parts.

- Do not wear jewelry, unbuttoned cuffs, ties or loose-fitting clothing.
- Tie long hair back when working near moving or rotating parts such as the flywheel or propeller shaft.
- Keep hands, feet and tools away from all moving parts.
- Keep all guards in place when the engine is operating.
- Use caution when working with ski or mooring lines so they do not become entangled with the propeller.



Exposure Hazard: Wear personal protective equipment, including appropriate clothing, gloves, work shoes, eye and hearing protection, as required by the current task.



Control Hazard: Do not operate the boat while you are under the influence of alcohol or drugs or if feeling ill. Federal laws prohibit operating a boat under the influence of alcohol or drugs. These laws are vigorously enforced.



CAUTION

The safety messages that follow have CAUTION level hazards. These safety messages describe hazardous situations that, if not avoided, could result in minor or moderate injury.



Slip/Trip Hazard: Keep the boat free of water, oil, mud and other foreign matter. Do not wax deck and swim platform surfaces. Remove anything that creates slippery areas around the boat.

NOTICE

The safety messages that follow have NOTICE level hazards. These messages are used to indicate a situation that can cause damage to the boat and accessories and/or the environment, or cause the equipment to operate improperly.

- *Unapproved modifications to the boat or systems may impair the boat's safety and performance characteristics and shorten the boat's life. Any alterations to the boat may void its warranty. Always consult the boat manufacturer before making modifications or adding equipment.*
- *ALWAYS be environmentally responsible. Follow the guidelines of the EPA or other governmental agencies for the proper disposal of hazardous materials such as engine oil and fuel. Collect all trash and dispose properly on shore. Keep our waters clean! Consult the local authorities or reclamation facility.*

CARBON MONOXIDE (CO)**DANGER**

Exhaust Hazard: CO gas is colorless, odorless and extremely dangerous. All engines and fuel-burning appliances produce CO as exhaust. Direct and prolonged exposure to CO will cause brain damage or death. Always avoid exposing your passengers or yourself to CO.

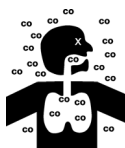

Even with the best boat design and construction, plus the utmost care in inspection, operation and maintenance, hazardous levels of CO may still be present in accommodation areas under certain conditions. To reduce CO accumulation, always provide adequate ventilation in the boat interior by opening the deck hatches, windows or canvas.

Do not confuse carbon monoxide poisoning with seasickness, intoxication or heat stress. If someone complains of irritated eyes, headache, nausea, weakness, dizziness or drowsiness, or you suspect carbon monoxide poisoning, immediately move the person to fresh air, investigate the cause and take corrective action. Seek medical attention if necessary.

Always use a CO detector in confined areas where there is a possibility of CO buildup, such as enclosed canvas, sleeping quarters, galleys and head compartments. Regularly check the condition of the CO detector for proper operation.

Make sure that all passengers know what the CO detector alarm sounds like. If the alarm sounds, shut down engines and generator, move passengers to fresh air for at least 10 minutes, reset the alarm and investigate the cause. Ventilate the space thoroughly before restarting engines and generator.

Test the carbon monoxide detector operation before each trip, at least once a week and after the boat has been in storage. Also have the CO detectors professionally tested at regular intervals. Most CO detectors are required to be replaced every 5 years – see the OEM manual.

Potential Causes of CO Poisoning While Under Way

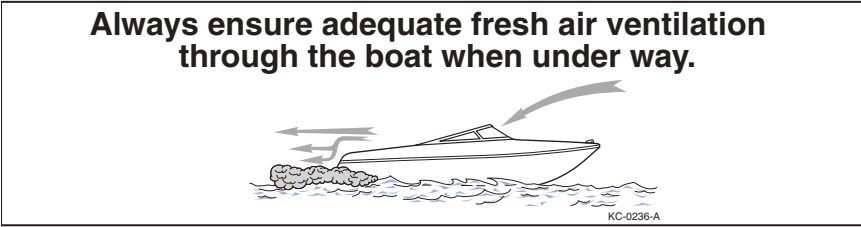
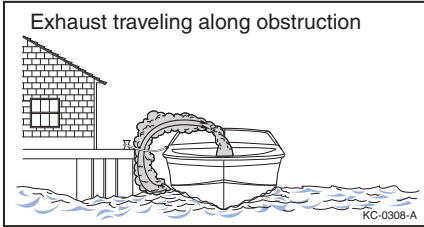
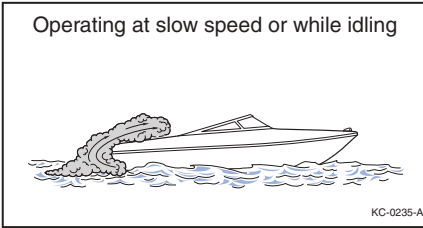
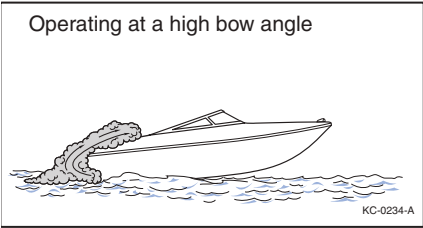
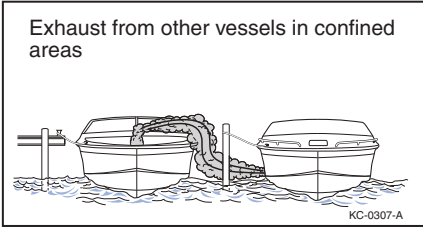
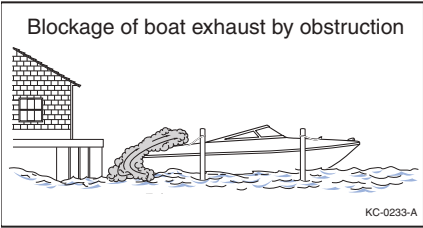

KC-0301-B

REQUIRED BOATING SAFETY EQUIPMENT AND REGULATIONS

**U.S. Coast Guard Minimum Onboard Safety Equipment Required
(Your boat may be equipped with one or more requirements by the manufacturer, but it is the boat owner's responsibility to have these items on board.)**

	CLASS A: LESS THAN 16 FT (4.9 M)	CLASS 1: 16 TO LESS THAN 26 FT (4.9 TO LESS THAN 7.9 M)	CLASS 2: 26 TO LESS THAN 40 FT (7.9 TO LESS THAN 12.2 M)	CLASS 3: 40 TO 65 FT (12.2 TO 19.8 M)
LIFE JACKETS AND PERSONAL FLOTATION DEVICES (PFDs)	One U.S. Coast Guard-approved wearable life jacket for each person on board	One U.S. Coast Guard-approved wearable life jacket for each person on board and one throwable PFD device		
VISUAL DISTRESS SIGNALING DEVICES	One (1) electric distress light OR three (3) day and night combination red flares	One orange distress flag or one electric distress light OR three floating or handheld orange smoke signals and one electric distress light OR three day and night combination red flares, handheld, parachute or meteor type		
AUDIBLE SIGNALING DEVICES	A boat less than 39.4 ft (12 m) must have on board an efficient sound-producing device. (Example: hand or mouth whistle OR a compressed or powered air horn)			A boat 39.4 ft (12 m) but less than 65.6 ft (20 m) in length must carry a power whistle OR powered air horn
NAVIGATION LIGHTS	Regulations require that navigational lights be clearly lit and properly displayed at all times between sunset and sunrise and always when operating in reduced visibility while boating			

Section 3

	CLASS A: LESS THAN 16 FT (4.9 M)	CLASS 1: 16 TO LESS THAN 26 FT (4.9 TO LESS THAN 7.9 M)	CLASS 2: 26 TO LESS THAN 40 FT (7.9 TO LESS THAN 12.2 M)	CLASS 3: 40 TO 65 FT (12.2 TO 19.8 M)
FIRE EXTINGUISHERS	<p>One 5-B type (U.S. Coast Guard-approved)</p> <p>If the boat meets any one or more of the following conditions, the boat must carry one 5-B type USCG-approved extinguisher on board:</p> <ul style="list-style-type: none"> • Inboard/sterndrive engine powered • Has closed compartments where portable fuel tanks can be stored • Has double bottom construction that has areas where air or gases can be open or trapped • Has an enclosed living space • Has compartments where flammable, combustible or explosive materials are stored • Has permanent fuel tanks installed • Boat is 26 ft (7.9 m) or more in length 		<p>One 20-B OR two 5-B type (USCG-approved) (A fixed extinguishing system is equal to one 5-B.)</p>	<p>One 20-B AND one 5-B OR three 5-B type (USCG-approved) (A fixed extinguishing system is equal to one 5-B.)</p>
ENGINE CUT-OFF SWITCH	<p>Powered boats less than 26' (7.9 m) operating in Federal waters must be equipped with an engine cut-off switch and operator interface.</p>		<p>N/A</p>	

FIRE EXTINGUISHER

USCG-approved fire extinguishers are required on all Class I, II and III boats. Mount all handheld fire extinguishers in readily accessible areas away from the engine compartment and other combustible devices. All passengers must know the location and operating procedure of each extinguisher. Follow the manufacturer's instructions for proper use and operation of the fire extinguisher.

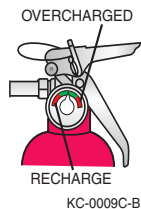

All fire extinguishers used on marine boats must be classified to extinguish type B fires (gasoline, oil or grease). The size and number of required fire extinguishers depend on the size of the boat. The two type B fire extinguishers commonly used are 5-B and 20-B. Type B fire extinguishers are classified by the different extinguishing compound amounts used in each.

Check the fire extinguisher condition and pressure gauge regularly, if not before every trip, to ensure that the fire extinguisher is in good operating condition and is fully charged. If the fire extinguisher is damaged or not properly pressurized, replace it. Disposable (non-rechargeable) fire extinguishers with a date of manufacture stamped on the bottle older than 12 years must be removed from service and no longer count towards the minimum carriage requirements. Expired extinguishers may be carried aboard for backup if they are otherwise still in good operating condition.

The graphic shown identifies the location of the fire extinguisher. Be sure to read and familiarize yourself with the operating instructions on the fire extinguisher nameplate. Inspect the fire extinguisher monthly. Verify that the fire extinguisher:



- Is visible and access is unobstructed
- Is properly mounted and secure
- Nameplate is legible
- Pull pin and/or original visual inspection tamper seal is installed and still intact
- Pressure gauge needle reads within the green operable area
- Discharge nozzle and/or hose assembly is unobstructed and securely attached

For additional information, see the Fire Extinguisher Manual supplied in the Skipper's Kit.

See the *U.S. Coast Guard Minimum Onboard Personal Safety Equipment Required* section of this manual for specific onboard requirements.

LIFE JACKETS

Boaters enjoy the feel of sun and spray, so it's tempting to boat without wearing a life jacket, especially on nice days. However, the failure to wear life jackets is by far the number one cause of boating fatalities.

Modern life jackets are available in a wide variety of shapes, colors, sizes and technologies. Many are thin and flexible. Some are built right into fishing vests or hunter coats. Others are inflatable and as compact as a scarf or fanny pack until they hit water and automatically fill with air. Ensure all passengers on board understand where the life jackets are located and how to put them on and use them.

There's no excuse for not wearing a life jacket on the water. Boat dealers or marine stores are the best sources for guidance when selecting this most important piece of safety equipment.

Starting in 2020, the U.S. Coast Guard working in cooperation with Transport Canada started transitioning to new life jacket labeling based on a performance classification system acceptable in both countries. If you have older approved life jackets, devices are approved in one country or the other, but not both. U.S.-approved devices are still acceptable in the U.S., and Canadian-approved devices are still acceptable in Canada when used in accordance with the approval label.

Always check and read the manufacturer's information booklet and label provided with all new life jackets. They will provide valuable information, including size, type, intended use, approval, inspection, and care information. For more information, go to <http://wearitlifejacket.com/>.

Things to Know about Life Jackets:

- Life jackets are now classified as wearable or throwable on the label.
- We recommend that all boaters and passengers wear a life jacket at all times while boating.
- Certain life jackets are designed to keep the head above water and help you remain in a position that permits proper breathing.
- To meet USCG requirements, a boat must have an approved life jacket for each person aboard. Boats 16 feet (4.9 meters) and over must have at least one throwable device as well.
- All states have regulations regarding children wearing life jackets. Special life jackets for children are available and based on the weight of the child.
- Adult-sized life jackets will not work for children. To work correctly, a life jacket must be worn, fit snugly and not allow the child's chin or ears to slip through.
- Test life jackets for wear and buoyancy at least once each year. Discard waterlogged, faded, leaky or damaged jackets.
- Properly stow life jackets but make them easily accessible.

- A life jacket, especially a snug-fitting flotation coat or deck-suit style jacket, can help people survive in cold water.
- Various types of life jackets are also available for pets.
- A life jacket can save a boater's life, but only if the boater wears it. Set the example and wear it whenever near the water.

Life Jackets Must Be:

- New jackets must be USCG or Transport Canada approved
- In good and serviceable condition
- Appropriately sized for the intended user
- Appropriate for the water activity
- Snug-fitting
- The best life jacket is the one you will wear

Accessibility

- Throwable devices must be immediately available for use in emergency situations.
- Wearable life jackets must be readily accessible.
- Boaters must be able to locate and put them on in a reasonable amount of time in an emergency.
- They should not be stowed in plastic bags, in locked or closed compartments, or have other gear stowed on top of them.

Child Life Jacket Federal Requirements

No person may operate a recreational boat underway with any child under 13 years old aboard unless each such child is either: (1) Wearing an appropriate PFD approved by the Coast Guard; or (2) Below decks or in an enclosed cabin.

Some states require that children wear life jackets at all times; check with the state boating safety authorities.

Since children grow quickly, many boat launches now feature free use of children's life jackets in several different weight categories.



SCAN ME VIDEO

KCB-0130

Life Jacket Requirements for Certain Boating Activities Under State Laws

The USCG recommends, and many states require, wearing USCG-approved life jackets:

- For waterskiing and other towed/surf activities, use a life jacket designed for waterskiing. **It is illegal in many states to participate in towed water sports without a USCG-approved life jacket. Be aware that some specialized water sports vests are NOT USCG-approved and should be worn in addition to a USCG-approved life jacket.**
- While operating personal watercraft (PWC) use a life jacket marked for PWC or waterskiing use.

Check with the state boating safety authorities. Other rules may apply if boating in an area under the jurisdiction of the Army Corps of Engineers or a federal, state or local park authority. Special local rules are usually posted at the boat launch.

The new life jacket labels make it easier for the boat owner to choose the appropriate sizes and types of jackets for the boat. Labels may be in English, French Canadian or both languages depending on where they are marketed, but all will use icons for key performance indicators.

Size

Chest size is used on ADULT devices to further define the fit not used on all others. Weight is used to define the basic size groups of:

- INFANT <30 LBS
- CHILD 30-50 LBS
- YOUTH 50-90 LBS
- ADULT >90 LBS

Performance Level

The performance level indicates the amount of floatation provided. The higher the number, the more floatation at the increase in bulk.

- Lower numbers are more comfortable to wear and are a good choice for near-shore, calm water boating.
- Mid numbers offer more stability for people who do not swim and for novice swimmers and are a better choice for coastal boating.
- Higher numbers have the greatest floatation and are the best choice for remote areas where rescue times may be long, for non-swimmers, and for offshore use.

Turnability

Typically, jackets with low performance levels will not turn an unconscious person face-up. Jackets with mid performance levels may not turn an unconscious person face-up. Jackets with high performance levels will turn an unconscious person face-up.

Warnings

Some life jackets are not approved for waterskiing, tubing, wakeboarding, white-water paddling, or use on a personal watercraft.

Find More Information

Additional information on the life jacket in the owner's manual and web sources.

Manufacturer and Approval Information

Manufacturer's information for possible future recalls. USCG approval number and certification agency to assure the jacket meets the law and is safe to use.

Use, Care and Storage Information

A summary of the use, care and storage information contained in the owner's manual.

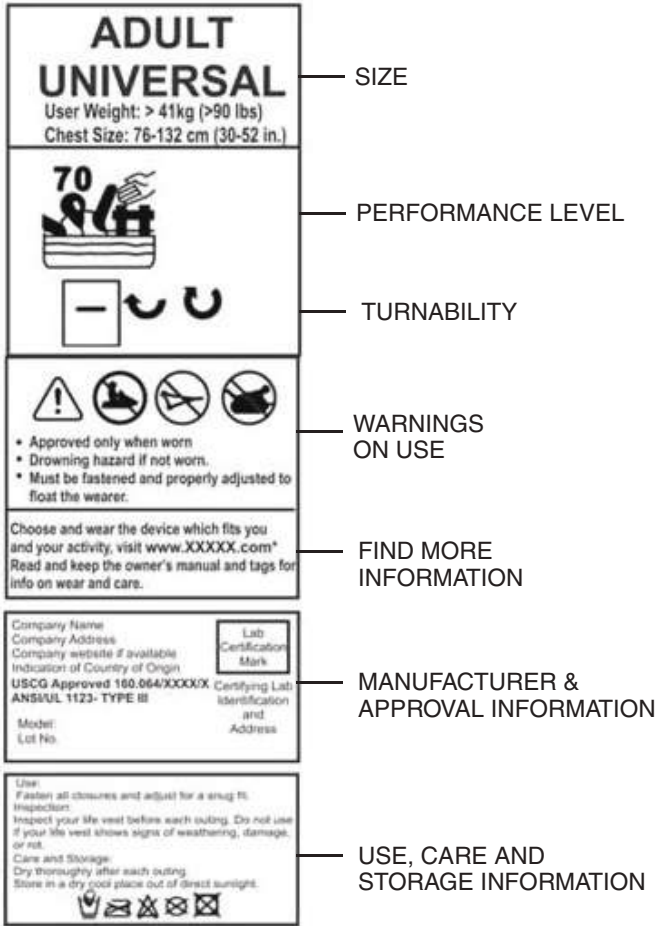

KCB-0129

Inflatable Life Jackets

U.S. Coast Guard-approved inflatable life jackets are authorized for use by persons 16 years of age and older (check the label).

- They require regular maintenance. Also, pay attention to the condition of the inflator.
- They must have a full cylinder and all status indicators on the inflator must be green. If all status indicators are not green, the device is not serviceable and does not satisfy the legal requirements for the wearable life jacket carriage requirement.
- They must be worn at all times.

AUDIBLE SIGNALING DEVICES

Audible (sound) signals are required to be on board all boats to alert other boats of your presence or intentions. A boat less than 39.4 feet (12 meters) must always have an efficient sound-producing device on board (Example: hand or mouth whistle, or a compressed or powered air horn).

A boat at least 39.4 feet (12 meters) but less than 65.6 feet (20 meters) operating in inland waterways must always have a power whistle or powered air horn and a bell on board.

All devices must be acceptable for use in marine environments, audible for 1/2 nautical mile and maintain a continuous four- to six-second sound duration. The diameter of the bell's mouth must be a minimum of 7.9 inches (20.0 centimeters).

Ensure all passengers understand how to operate all audible distress signaling devices on board. Keep these devices in a readily accessible area and within immediate reach at all times when boating.

See the *U.S. Coast Guard Minimum Onboard Personal Safety Equipment Required* section of this manual for specific onboard requirements and see the *Navigational Lights and Night Operation* section of this manual for usage information.

VISUAL DISTRESS SIGNALING DEVICES

There are a variety of VDS devices for day, night, or day and night use. Pyrotechnic devices can be dangerous if used improperly; read the instructions before using. Pyrotechnic devices expire and must be replaced every few years, as stamped on the unit. Be sure to properly dispose of old pyrotechnics.

Distress lights and strobes are equipped with batteries that must be replaced every few years, as stamped on the unit.

Section 3

Advancements in technology have led to a number of electronic VDS devices (eVDSD). These devices are battery-powered and contain one or more LED lights and possibly other features. While eVDSDs are not “USCG Approved,” they are accepted as “equivalent” if compliant with RTCM Standard 13200.0 for nighttime use. Several can be equipped with a VDS flag for day/night use and/or a whistle for audible signaling. Talk to your boat dealer about the best device for your use.

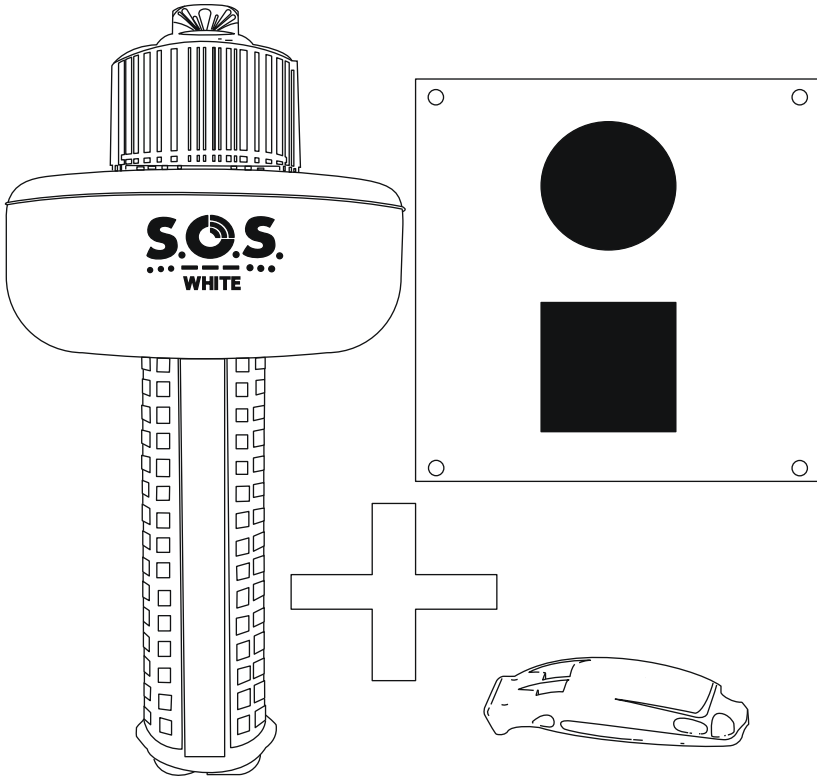

KCB-0131

Boats less than 16 feet (4.9 meters) must have USCG-approved visual distress signals (VDS) on board when operating between sunset and sunrise in coastal waters, including ocean bays, gulfs and sounds, as well as the Great Lakes, seas, bays and river mouths that are 2 or more miles wide and only to the point proceeding inland where the water narrows to less than 2 miles. Visit the U.S. Coast Guard website for additional information on specific VDS requirements for the boat.

Ensure all passengers on board understand how to operate all VDS. Keep VDS in a readily accessible area and within immediate reach at all times when boating.

VISUAL DISTRESS SIGNALS

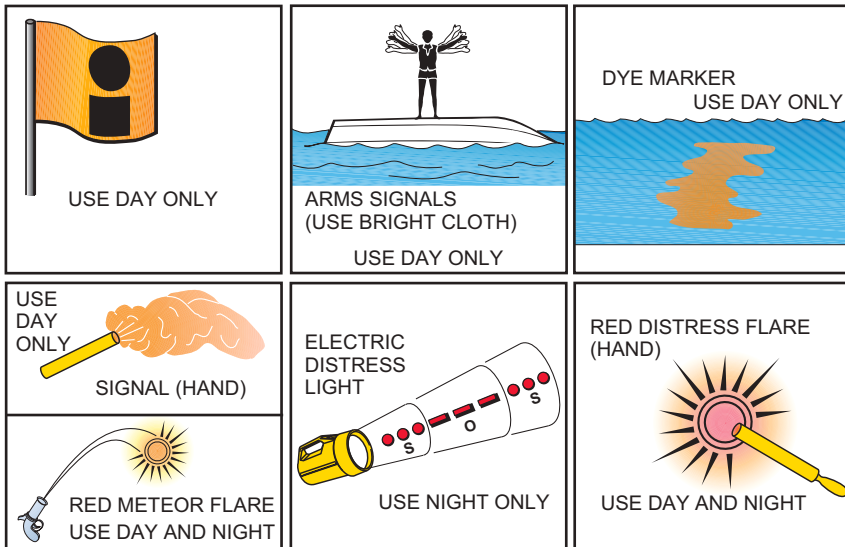

KC-0008C-B

Regulations prohibit using pyrotechnic VDS or any VDS in non-emergency situations.

VDS must be:

- USCG-approved
- In proper operating condition
- Safely stowed and readily available
- Within the clearly marked expiration date stamp on the device (where applicable)

Types of VDS vary by emergency situation. VDS are classified as either pyrotechnic or non-pyrotechnic.

NOTE — Some pyrotechnics may be restricted on certain bodies of water. Check with local authorities, or visit the National Association of State Boating Law Administrators (NASBLA) website: <http://www.nasbla.org> or the U.S. Coast Guard website: <http://www.uscg.mil> for additional information.

See the *U.S. Coast Guard Minimum Onboard Personal Safety Equipment Required* section of this manual for specific onboard requirements.

ENGINE EMERGENCY STOP SWITCH AND LANYARD

The engine cut-off switch (ECOS) is an extremely important safety device. The engine cut-off switch link (ECOSL) is a device which connects the operator to the engine cut-off switch. This may be a physical lanyard or an electronic fob. Use the engine cut-off switch when operating the boat's engine. These safety devices prevent the boat from becoming a runaway if the operator is accidentally thrown from the seat or away from the helm. The USCG recommends and many states require the use of the cut-off switch by law. Check with local and state authorities about usage requirements to avoid potential fines.

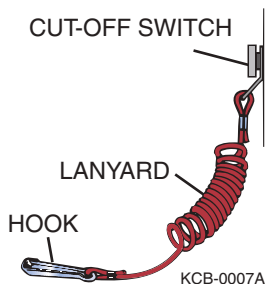

Starting April 1, 2021, individuals operating most types of powered boats less than 26' (7.9 m) in Federal waters are required to use an engine cut-off switch and lanyard while the boat is on plane or above displacement speed.

- Tiller-steered models may have a switch mounted on the tiller handle with a wrist lanyard.
- Side-mount controls may have a switch on the control box with a “clip-on” lanyard.
- Larger boats may have a helm-mounted switch with a “clip-on” lanyard.
- Some boats may have a wireless switch with an electronic FOB attached to the operator.

Consider having an extra lanyard or other rearming device readily available on board since the system cannot be overridden without the lanyard that is on the person who is now overboard. Rearming or bypassing the engine cut-off switch should not require continuous input from the operator.

⚠ WARNING **Control Hazard: Never remove or modify the engine cut-off switch and/or lanyard.**

- ***Always check the switch for proper operation. With the engine running in neutral, pull the lanyard. If the engine does not stop, have the switch repaired before continuing to operate the boat. Never operate the boat if the engine cut-off switch does not work.***
- ***Avoid accidentally pulling the cord lanyard during normal operation. Loss of engine power means loss of most steering control. Also, without engine power, the boat could slow rapidly. This could cause people and objects in the boat to be thrown forward.***

NAVIGATIONAL LIGHTS

Navigational lights are intended to alert other boats to your presence and course and their use is essential to boating safety and the prevention of collisions. Knowledge of navigation lights is necessary for the boat operator. Regulations require that navigational lights be clearly lit and properly displayed at all times between sunset and sunrise, and always when operating in reduced visibility. The placement, shape and visibility requirements of navigational lights vary depending on boat size, type, activity and the body of water. Do not allow passengers, gear or stowed items to block navigation lights. Check with local authorities, or visit the NASBLA or U.S. Coast Guard website for additional information.

If the boat is equipped with bow and/or stern pole style plug-in lights, be sure to orient the pole properly in the receptacle and lock in place. The white light is for the stern and the combination red/green light is for the bow, center. If using separate bow lights, the red light is for the front left (port), and the green light is for the front right (starboard). After inserting, check for proper operation of the lights.

For additional information, see the *Navigational Lights and Night Operation* section of this manual.

LED LIGHTING

The navigational lighting required by the USCG from sunset to sunrise and in inclement weather is extremely important to boat navigation. The lighting rules are not only designed to indicate direction and right-of-way, but are also designed to prevent night blindness and confusion with navigational aid, emergency and shore-based lights.

The arrival of inexpensive LED lights and red/green/blue (RGB) controllers suitable for “show” use has become extremely popular with boaters. Installing supplemental lighting for “show” can be very dangerous, confusing and distracting to other boaters, and may be illegal. The operator is responsible for complying with local laws and must be familiar with local marine lighting regulations that are constantly evolving before use. Keep these points in mind for show lighting:

- Do Not install lighting outside of the boat above the waterline.
- Do Not install lighting inside the boat above the gunnels where the light source can be seen directly from outside the boat.
- Use caution when changing RGB light color, as some light colors may not be compliant with certain local ordinances; blue lighting is typically reserved for law enforcement use only.
- Be sure to switch off show lighting and lighted accessories such as speakers (not navigation lights) when underway. Most states allow the use of underwater lighting while underway.
- Use only factory-installed, low-intensity courtesy lighting or “mood” lighting when underway.

NOTICE

Never use onboard accessory equipment containing LED lighting when underway.

RECOMMENDED SAFETY EQUIPMENT

Carry and know how to use the following equipment in addition to the required equipment on board at all times as an extra safety precaution:



Anchor and line with minimum 75 feet (23 meters) of line	GPS Global Positioning Device
Auxiliary starting battery	Insect repellent
Binoculars	Local charts and compass
Boat hook	Mirror, whistle and strobe light
Cellular phone with waterproof case and lanyard	Mooring lines
Compass	Navigational and interior light bulbs
Dock fenders	Oar/paddles
Dry bag	Propeller, nut and washer
Duct and electrical tape	Radio
Electrical wire	Sharp folding pocket knife
Emergency food and water	Solar USB charger and cable
Emergency Position Indicating Radio Beacon (EPIRB)	Spark plugs
Engine lubricant	Sunglasses and sun block
Extra drain plug	Thermal clothing
Extra transom plug	Throwable life ring
First aid kit and manual	Tool kit including propeller replacement tools
Flashlight and radio batteries	Tow line
Foul weather gear/clothing	VHF-FM/AM with weather band radio
Fuses	Waterproof flashlight

SAFETY AND TRAINING

There is a vast amount of recreational boating regulatory, safety and training information online, and much of it is free. This information covers laws, aids to navigation, rules of the road, hands-on boating safety courses, boat safety checks and much more for both novices and experienced boaters. Go to the following sites for more information:

- United States Coast Guard
www.uscgboating.org
- United States Power Squadron
www.usps.org
- BoatU.S. Foundation
www.boatus.org

SITUATIONAL AWARENESS

A good captain knows that it is important to continuously observe the surroundings and traffic when operating. Good captains also use their eyes to track things around the boat and their ears to hear engine and mechanical issues. Technology should only be used to supplement the conditions and events happening around you and is not meant to replace situational awareness. While available technology and automation help captains see the big picture, the captain is responsible for knowing what is going on around the boat. If possible, post a lookout or lookouts when underway.

Do not get immersed in the boat's technology or blindly follow GPS routes without keeping watch or consulting depth charts. Study the manuals for each piece of equipment and monitor the information for the task at hand, be it depth, traffic, infrared camera, engine data, course or weather.

DRIVING DEFENSIVELY

When operating a boat, adopting a defensive driving approach is essential for ensuring the safety of everyone on board and around you. Defensive boating involves anticipating potential hazards and taking proactive measures to avoid accidents. Always be aware of your surroundings, including other boats, swimmers, and obstacles in the water. Maintain a safe speed, especially in crowded or unfamiliar areas, and keep a safe distance from other vessels. Regularly check your mirrors and blind spots, and use your horn or signals to communicate your intentions to other boaters. The goal is to prevent accidents before they happen by staying vigilant and prepared.

BOAT-SHARING SAFETY

Sharing boats is becoming more popular in the boating culture. Boating has seen an influx of new, inexperienced and untrained boaters due to peer-to-peer boat-sharing apps and boat clubs. It is increasingly probable that someone on the water “tried” boating because it looked fun. Many of the boat owners sharing their boats do little more than cover safety equipment, starting, stopping and docking instructions. With shares lasting half a day or less, there is little time for much training, let alone covering the rules of the road and navigation.

Boat-sharing is in a legal gray area and is not clearly defined in maritime law. Enforcement of existing rules is nearly impossible and almost always after-the-fact. Operators should assume that the other boat operator is untrained and should drive defensively. Boaters choosing to share their boat should discuss the issue with their insurance agent first and consider a mandatory captain requirement. Use only reputable sharing services and frequently check for new or updated USCG and state requirements.

SMALL BOATS AND SWIMMERS

Canoes, kayaks, paddleboards and swimming inflatables have become impulse purchases for many, as they appear fun to use and prices have fallen. Most of these operators are new to the sport and have no training on rules of the road or navigation. This is further complicated by the low, thin profile that makes these small boats difficult to see, especially in the sun, glare and rough water. Operators should keep a close lookout for these boats, swimmers and other boats. Assume that the person is untrained and give them plenty of space.

KNOWING THE BOAT

Be thoroughly familiar with onboard systems and other equipment, especially the critical systems and equipment such as throttle and shift controls, steering, backup steering, running lights, fuel filters, sea strainers, and all emergency safety equipment. Should an emergency arise, the captain will need to act safely and efficiently.

SPECIAL NEEDS PASSENGERS

Keep these special precautions in mind when enjoying a day on the water with passengers who have special needs.

Toddlers

- Never leave children in the boat without adult supervision.
- Must weigh at least 18 pounds (8.2 kilograms), since that is the smallest children's life jacket approved by the USCG. Life jacket must be worn whenever near the water.
- Any device the child is placed in must have flotation.
- Child-proof the boat just like a home. Be sure all gates and compartments are closed and latched.
- Keep a close watch on the child's reaction to speed and conditions and react accordingly.
- Use a higher than normal SPF waterproof sunscreen and re-apply more often than usual.
- Find a safe area to put the child down without risk of going overboard. Allow the child to get accustomed to the surroundings before launching/leaving.
- Keep trips short, but let them have some fun if possible.

Pregnant Women

- Go boating during the day and in calm seas.
- Avoid sharp turns and slow down for large wakes.
- Drink more water than usual to stay hydrated.
- It is a good idea to stay seated in the accommodation deck area while underway.
- Stay close to the home port in the third trimester.

People with Handicaps and Elderly People

Depending on the disability, there are many marine-specialized options available to make boats safer and friendlier. Researching on the internet for your specific needs is the best way to start.

Pets

- Not all pets can swim; consider a life jacket.
- If playing fetch in the water, get a pet-friendly boarding ramp to make re-boarding easier.
- Provide a shaded area and plenty of fresh drinking water.
- Consider foot protection for hot sand and boat surfaces.
- Allow the pet to get accustomed to the surroundings before launching/leaving. Keep the first outing short to allow the pet to get used to the boating environment.

CRUISING LIMITATIONS

- Scan constantly for people, objects and other watercraft. Be alert for conditions that limit your visibility or block your vision of others.
- Operate defensively at safe speeds and keep a safe distance from people, objects and other watercraft.
- Do not follow directly behind other watercraft.
- Do not go near others to spray or splash them with water.
- Avoid sharp turns or other maneuvers that make it hard for others to avoid you or understand where you are going.
- Avoid areas with submerged objects or shallow water.
- Operate within your limits and avoid aggressive maneuvers to reduce the risk of loss of control, ejection and collision.
- This is a sophisticated boat—not a toy. Sharp turns or jumping waves or wakes can increase the risk of back/spinal injury (paralysis), facial injuries, broken legs, ankles and other bones. Do not jump waves or wakes.
- Do not operate the boat in rough water, bad weather or when visibility is poor; this may lead to an accident causing injury or death. Be alert to the possibility of bad weather. Take note of weather forecasts and the prevailing weather conditions before setting out in the boat.
- Leave a “float plan” with a responsible person on shore. Tell where you plan to go and when you plan to arrive, and provide a description of your boat. Advise this person if your plans change and also when you arrive to prevent false alarms. Refer to *Float Plan* in this manual for additional information.

HAZARD INFORMATION

- Never start the engine or let it run for any length of time in an enclosed area. Exhaust fumes contain carbon monoxide, a colorless, odorless gas that may cause death within a short time. Always operate the boat in an open area.
- Do not use the reverse function to slow down or stop the boat, as it could cause you to lose control, be ejected or impact the steering wheel or other parts of the boat. This could increase the risk of serious injury. It could also damage the shift mechanism.
- Reverse can be used to slow down or stop during slow speed maneuvering, such as when docking. Once the engine is idling, shift to REVERSE and gradually increase engine speed. Make sure that there are no obstacles or people behind you before shifting into REVERSE.
- Stop the engine and remove the clip from the engine cut-off switch before removing any debris or weeds that may have collected around the propeller.

WATER SPORTS

DEVELOP WATER SENSE

What is water sense? Water sense is developed by familiarizing yourself with the boat, driving, water, equipment and maintaining vigilance.

Familiarize yourself and follow The Watersport Responsibility Code.



WARNING Control

Hazard: It is unlawful to participate in water sports while under the influence of alcohol or other drugs.



KCB-0098

Some boats are not designed or recommended to be used for water sports. For recreational boats, water sports include any activity performed in the water such as waterskiing, kneeboarding, wakeboarding, wakesurfing, hydrofoiling, swimming, diving, snorkeling or gliding using a device that may be pulled by a boat. Boats equipped with a ski pylon, tower or hard top tow point, or a transom-mounted ski tow eye can be used for most water sports in accordance with the capacity limits listed on the label.

Inflatables, also known as tubes, have some unique safety considerations and require the use of both stern eye strong points in combination with a proper tube harness and tow rope; see *Inflatables/Tube Tips* in this section for more information. Parasails and kites require specialized equipment and training and should never be used with a recreational boat.

Check with local and state authorities or water sports clubs and affiliations for additional information.

PLATFORM DRAGGING

These dangerous and even fatal activities can lead to any or all of the following, as well as other dangers not listed here:

- Carbon monoxide poisoning
- Severe injury from a rotating propeller
- Drowning or entrapment under the water

NOTICE

It is UNLAWFUL to be on or holding on to the boarding platform, swim deck, swim step, swim ladder or any portion of the exterior of the transom at any time while the boat is running or underway in any direction and at any speed.

 **WARNING** *Personal Injury Hazard: Body, teak or platform dragging is extremely dangerous and can be fatal. Never hold on to the transom of a boat while in the water when the boat is running or underway.*

- *Do not use the boarding platform or ladder for any purpose other than boarding the boat or entering the water.*
- *Do not use the boarding platform or ladder while the engine is running.*
- *Do not swim under the boarding platform when the engine is running.*

WATER SPORTS GUIDELINES

Boat Operator, Occupants and Participants

The following water sports guidelines only cover the general conditions that frequently arise. The participants must respond to the constantly changing weather and the conditions of the sea by using reasonable and safe judgment in light of the circumstances.

- Always ensure that all water sports participants and occupants of the boat, especially the operator, are fully aware at all times of the participants' condition and location in the water, as well as the surrounding environment.
- Make safety the primary concern of all involved during the activity. Only allow safe and capable participants to engage in the activity.
- The boat operator and water sports participants must always know their limitations in the activity and never exceed them.
- Never perform water sports in or near:
 - Congested areas
 - Restricted areas
 - Navigation or other waterway markers
 - Other boats
 - Other water sports participants
 - Obstructions in the water
 - Shorelines
 - Shallow water
 - Hazardous weather conditions
 - Hazardous waterways, rapid moving water, dams, spillways, etc.
 - Areas or times of restricted visibility
 - Hours between sunset and sunrise
 - Locations too far from shore that could hinder immediate rescue or emergency help if needed

- Always engage in water sports activities in safe waterways only.
- Always attach the water sports tow rope to approved attachment points on the boat.
- Never jump from a boat that is moving at any speed, and do not enter or exit the water when the engine is running.
- Never use different length ropes simultaneously for water sports activities.
- Always make sure that participants know and use approved skiing hand signals and common skiing courtesy.
- Before starting, always agree to speed and communication hand signals between the boat operator, spotter/observer and participants.
- Before starting, always inspect the water sports equipment and tow eye, tow point and tow line for safe operating condition, or damage that may lead to failure.

Boat Operator Specific Guidelines

The following guidelines are for the boat operator while a participant is in the water.

- Always have a “spotter” (designated observer) other than the boat operator on board to ensure the safety of the participants in the water and provide communication to and from the boat operator and the participants.
- Always turn the engine off from a safe distance when approaching participants in the water and allow them to reach the boat. Never run the engine near a person in the water.
- Never operate the boat in reverse to retrieve anyone in the water.
- Always return immediately to a fallen water sports participant. Always approach the participant on the operator’s side while keeping the participant in view from a direction opposite the wind or seas.
- Never drive directly at a person in the water or directly behind another boat.
- Always maintain a safe distance from people and objects in and on the water.
- Always look in the direction you plan to turn before turning the boat to pick up a fallen skier.
- Never retrieve any object from the water while the engine is running.
- Always keep the skier in view when the skier is entering or exiting the boat.
- Always watch the skier as the line begins to tighten (in case the rope wraps around ski or skier).
- Always look ahead before starting.
- Always start from a safe place with good forward and peripheral visibility.

Section 3

- Always check direction of steering before starting, ensuring that the boat steers straight.
- Always be aware of what is occurring in front of the boat, and of a participant's condition.
- Always display a "skier down" flag whenever a skier is in the water and not skiing.
- Always follow the approved towing pattern for the waterway in which you are operating.

Additional Guidelines for Participants in the Water

The following guidelines are for the water sports participant.

- Never participate in water sports if you cannot swim.
- Always wear a bright-colored USCG-approved activity life jacket at all times. Wear suitable protective clothing or gear and/or a wet suit to prevent impact injuries, abrasions and hypothermia.
- Never approach or enter the boat if the engine is running.
- Always avoid the boat's propeller. Even when the propeller is not rotating, its sharp edges can cause serious injury.
- Never put any part of your body through the handle of the ski line or wrap the line around any part of your body.
- Never enter the water from a boat that is running or moving at any speed.
- Always indicate that you are clear of the boat prior to the operator starting the boat or putting the boat into gear and tightening the rope.

Water Sports Safety

IMPORTANT

The following water sports safety warnings and practices represent some (but not all) common risks encountered by users. Always use common sense and good judgment.

Before skiers/riders get in the water: Waterskiing or riding instruction is recommended in advance. Instruction will teach general safety guidelines and proper waterskiing or riding techniques, which may reduce their risk of injury. For more information on waterskiing or riding schools, contact the dealer, association or local waterskiing club.

Inspect all equipment prior to each use. Check bindings, fins, tube, attachment, tow rope and flotation device. Do not use if damaged.

Special boat considerations: A knowledgeable and responsible driver along with a separate observer is the most important safety device on any boat.

- Some states have specific regulations for allowable propulsion systems that can be used for tow sports, especially wakesurfing. It is the operator's responsibility to know the applicable regulations.
- Never exceed the passenger or weight limitations of the boat.
- Never allow passengers to hang outside the boat or towed device or sit on the gunwales or anywhere outside of the normal seating area.
- Never allow water to overflow the bow or gunwales of the boat.
- Uneven weight distribution or additional weight may affect the handling of the boat.

Using the Boarding Platform / Ladder



WARNING *Personal Injury Hazard: Always turn the engine off whenever anyone is in the water near the boat.*

To board, carefully deploy and use the boarding ladder if available. You may also pull yourself onto the boarding platform to enter the cockpit of the boat. Boats equipped with a boarding platform have a few extra precautions to be aware of:

- NEVER allow anyone on the boarding platform or in the water near the platform while the engine is running.
- NEVER attempt to surf on or off the platform while the engine is running.
- NEVER “platform drag” or touch the boarding platform from the water while the engine is running.
- NEVER exceed the weight capacity of the boarding platform. All boarding platforms have weight limits. If there is no capacity decal, ask the dealer.
- Boarding platforms may be wet and slippery. Advise passengers to use caution and any available handholds when using the platform. Never apply wax to the working deck portion of the platform.
- If the boarding platform is equipped with a ladder, be sure the ladder is fully retracted and secured before operating the boat.
- If the boarding platform is removable, be sure it is properly secured before operating the boat.

SEATING LOCATIONS

Your tow boat is a high-performance craft capable of rapid acceleration, high speeds and tight turns. The operator is responsible for the safety of passengers and must instruct on the proper seating locations and the use of handholds. The number of persons onboard must be determined by the combined weight of passengers, gear and ballast and must not exceed the maximum weight capacity listed on the capacity plate. With full ballast, full fuel and gear for 5 adult skiers, the maximum number of persons based on weight may be 6, even though the capacity plate lists 11.

Passengers must always be seated in the proper locations, on the horizontal seat surface, and use the provided hand-holds while underway. The operator must pay special attention when children are riding in the bow seats as water conditions can change rapidly causing an unsafe condition. Small children should never be allowed to ride in the bow seats without adult supervision. Refer to the designated people placement for your model.

DESIGNATED SEATING POSITIONS

Centurion Ri265

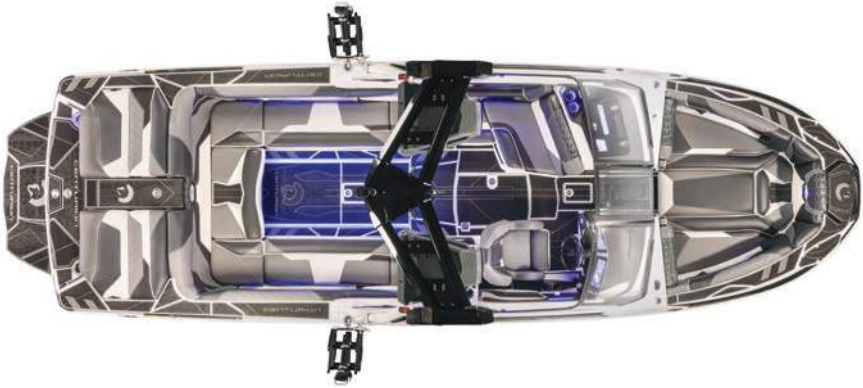

Yacht Certified

Centurion Ri245*

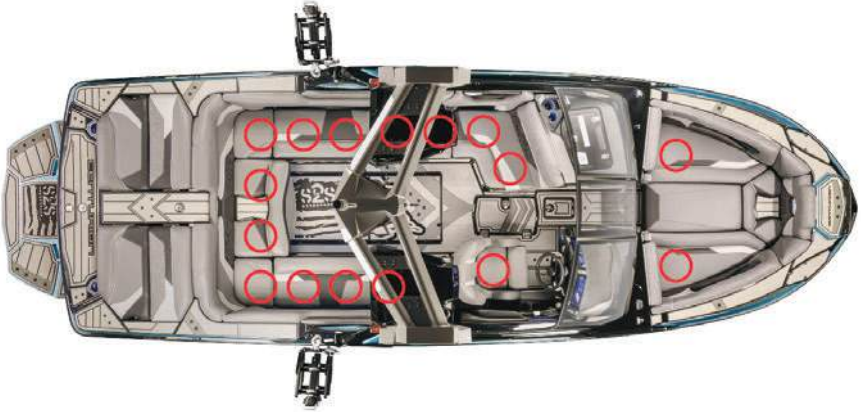

Centurion Ri230*

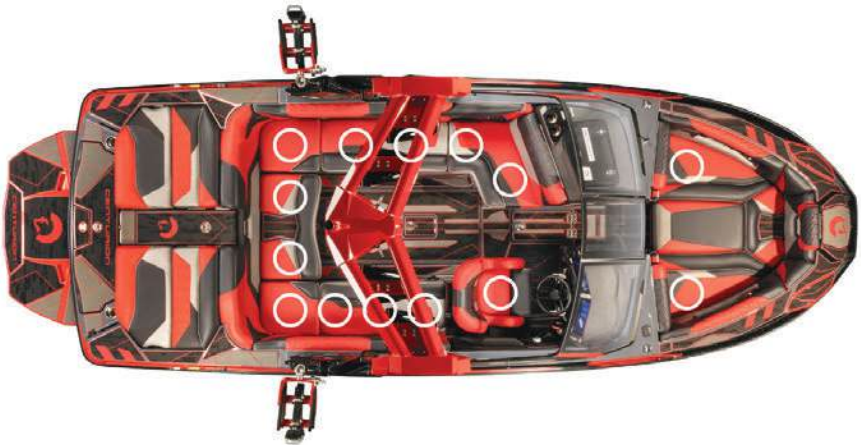

* The seating charts shown in these photos represent only the seats located within the boat, beneath the tower. It does not include or imply seating on top of the tower. We do not advertise or encourage passengers to sit on the tower.

Section 3

Centurion Fe25



Centurion Fe23



Centurion Fe22



Centurion Nv243

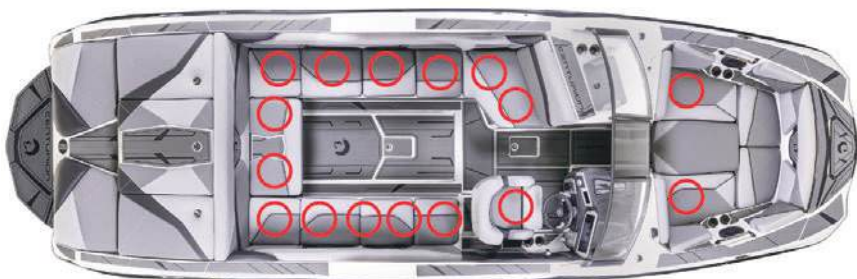

Centurion Nv233

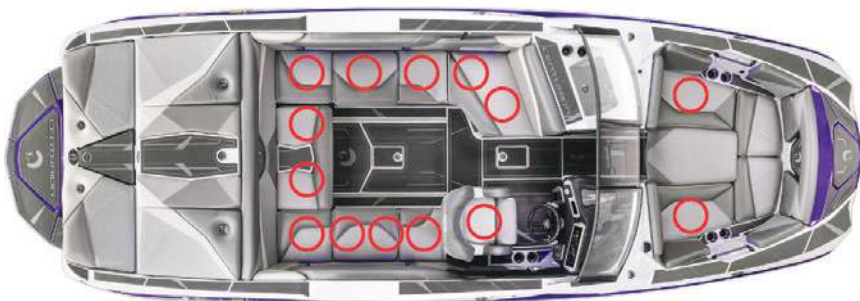

Centurion Nv213



This Page Intentionally Left Blank

CENTURION BOATS

Section 4

BOATING REGULATIONS AND YOUR RESPONSIBILITIES

The U.S. Coast Guard (USCG) is the federal authority on U.S. coastal and inland waterways, but state and local regulations may exist that exceed USCG regulations. The purpose of all these regulations is to assist the boating public and maintain navigational order on waterways.

Many state equipment requirements go beyond USCG requirements. Contact state and local boating authorities for further information. Equipment requirements for coastal and inland waters differ. Check with local authorities or the USCG for further information about coastal water requirements.

Boating regulations are enforced by USCG, state and local authorities. Operators/owners are subject to marine navigation regulations for both federal and state waterways. Operators/owners must comply if enforcement officers signal them to stop the boat or if they ask to board the boat.

Many USCG, state and local resources are available. For additional and current information on regulations, safety and navigation, contact the local USCG unit or local marine authority.

See the *References and Contact Information* section of this manual for a list of resources.

BOAT OWNER / OPERATOR RESPONSIBILITIES

As a boat owner/operator, understand and be aware of USCG federal regulations as well as state and local regulations where operating the boat. Boating regulations include, but are not limited to, boat regulations, boat equipment regulations and navigational regulations.

Operators/owners must have on board at all times all mandatory safety and boat equipment as regulated by the governing authorities. All equipment must be maintained in proper working order.

SAFETY

Boat owners/operators are legally responsible for their safety, the safety of their passengers and the safety of other boaters. In addition, they are responsible for the operation and navigation of the boat under all operating conditions. The boat must be in compliance with USCG safety equipment regulations.

REGISTRATION

The USCG requires that all power boats operated on the navigable waters of the United States be currently registered in the state in which they are principally used. Many states require current registration in that state whenever boating on waters within their state boundary. Always contact state boating authorities (and authorities in neighboring states) for registration information on boats and trailers.

Registration numbers must be current and clearly displayed on the boat according to the defined regulations. Registration certificates must be current and on board at all times.

State and local authorities may require additional registration for boating on certain waterways. Check with state and local authorities for additional registration information.

For more information visit:

- U.S. Coast Guard Office of Boating Safety:
<http://www.uscgboating.org>
- National Association of State Boating Law Administrators:
<http://www.nasbla.org>

INSURANCE

Boat owners are legally responsible for any damage or injury caused when they operate the boat when an accident or collision occurs. They are also legally responsible even when someone else operates the boat and causes damage or injury. Individual states have laws detailing minimum insurance needs. Contact the insurance agent to verify the type of insurance needed BEFORE operating the new boat.

Boating Regulations and Your Responsibilities

REPORTING ACCIDENTS

The USCG requires the owner/operator of a boat involved in an accident to report the incident to the proper marine law enforcement agency for the state in which the accident occurred. If a person dies or disappears as a result of a recreational boating accident, the boat owner/operator must immediately notify the nearest state boating authority. If a person dies or has injuries requiring more than first aid, the owner/operator must file a formal report within 48 hours of the accident. An owner/operator has 10 days to file a formal report for accidents exceeding \$500 in property damage or complete loss of the boat. Go to <http://uscgboating.org/recreational-boaters/>, Accident Reporting, for information and form download.

BOATING UNDER THE INFLUENCE



KCB-0011

Federal and state laws prohibit the operation of a boat while under the influence of alcohol or drugs, and authorities actively enforce these regulations. If the operator's blood alcohol content is at or above the legal limit, violators are subject to civil and criminal penalties and imprisonment. Operating a boat under the influence can also result in a loss of motor vehicle driving privileges.

Alcohol and drugs slow reaction time and affect judgment. This type of impaired operation may result in death or severe personal injury.

Owners/operators are responsible for their passengers, including alcohol and drug use and onboard behavior.

Regulations and penalties for operators and passengers may vary from state to state. Contact local and state boating authorities for specific information.

OPERATOR'S LICENSE AND EDUCATION

This manual does not provide complete training on all aspects of boating safety, operation or regulations. Boating authorities highly recommend that all boat operators and passengers seek additional training in boating safety and seamanship from a USCG-approved course.

Licensing requirements can vary widely from state to state. Most states require operators under the age of 18 to be licensed; however, some states require all operators to be licensed and have the license on the boat during operation. Some states require boat operators to complete a boating education/safety course to obtain a safety certificate before licensure. Pay special attention if you will be operating on boundary waters shared by two or more states, as the requirements may change once you cross the boundary.

Check with state and local authorities for requirements of an operator's license, certificate or training before you or anyone operates the boat.

Section 4

See the *References and Contact Information* section of this manual for a list of some of the agencies and organizations that offer water/boating safety courses, first aid/CPR, or other recommended training and/or information.

OPERATION BY MINORS

Minors must always be supervised by an adult whenever operating a boat. Many states have laws regarding the minimum age and licensing requirements of minors. Regulations may vary from state to state. Contact local and state boating authorities for specific information.

EMERGENCY ASSISTANCE

An operator seeing a distress signal or suspecting a boat is in trouble must assume it is a real emergency and render assistance immediately as long as it can be done safely.

In accordance with Federal law, in U.S. waters, the operator must render assistance to any individual found at sea in danger of being lost, so far as the operator can do so without serious danger to the operator's vessel or individuals on board. An operator who fails to render such assistance can be fined not more than \$1,000, imprisoned for not more than 2 years, or both. The 1971 Boating Safety Act grants protection to a "Good Samaritan" boater providing good faith assistance, and absolves the boater from any civil liability arising from such assistance.

Under general maritime law in international waters on the other hand, if the operator undertakes to perform acts to rescue or aid those in distress, the operator is subject to liability for reckless or wanton conduct or, for failure to exercise reasonable care (negligence) if he worsens the position of the victim.

NOTICE

The operator in charge of the boat is obligated to provide assistance to any individual in danger if such assistance can be provided safely. Carefully assess the situation at hand and assist if possible. If the operator does not possess the skills to safely assist another boat in trouble with the highest degree of care, call for help and stay in the area until help arrives.

NEGLIGENT OPERATION

Federal law prohibits the negligent or grossly negligent operation of a boat and/or interference with the safe operation of a boat so as to endanger lives and/or property. Some actions that may constitute grossly negligent operation (criminal offense) are:

- Operating a boat in a designated swimming area
- Excessive speed in the vicinity of other boats or in regulated waters
- Hazardous waterskiing or other water sports practices

Boating Regulations and Your Responsibilities

- Bow riding, or riding on a seat back, gunwale, boarding platform or transom
- Operating a boat while under the influence of alcohol or drugs (severe penalties may be imposed for boating under the influence [BUI])

Other actions that constitute negligent operation, such as, but not limited to:

- Failure to use handhold
- Overloading or improper loading
- Using a boat in weather or sea conditions beyond the intended design of the boat or beyond the skill or experience of the operator
- Continued operation with operator's visibility blocked or impaired
- Modification to boat causing an unsafe operating condition

PROTECTING THE ENVIRONMENT

Our lake, river and ocean resources must be protected to be enjoyed by future generations. Boat owners/operators are responsible for protecting the natural environment and wildlife by keeping waterways clean.

U.S. waters are covered by several water pollution regulations administered by numerous federal and state agencies. Laws vary between local, inland, coastal, ocean and international waters. Laws can be enforced by local and state authorities as well as the USCG. For recreational boats, U.S. Federal Water Pollution Control, Oil Pollution Control and Refuse Acts cover U.S. waters, and the MARPOL treaty covers international waters. In any case, pollution prevention centers around three areas:

- Sewage pollution
- Garbage (solid waste) pollution
- Oil pollution

As a boater, make it a point NOT to dump or discharge ANYTHING into waters and tell passengers to respect this rule. Return all trash after boating and dispose of it properly on shore.

DISCHARGE OF OIL PROHIBITED

The Federal Water Pollution Control Act prohibits the discharge of oil or oily waste into or upon the navigable waters of the United States, or the waters of the contiguous zone, or which may affect natural resources belonging to, or under the exclusive management authority of the United States. If such discharge causes a film or discoloration of the surface of the water, or causes a sludge or emulsion beneath the surface of the water. Violators are subject to substantial civil penalties and/or criminal sanctions including fines and imprisonment.

KC-6020

MARPOL TREATY

The USCG enforces the International Convention for the Prevention of Pollution from ships, commonly referred to as the MARPOL Treaty (MARine POLLution). This treaty prohibits the overboard dumping of all ship-generated plastics, chemicals, garbage and oil. Contact the USCG for further information.

AQUATIC INVASIVE SPECIES (AIS)



KC-6027

Aquatic Invasive Species (AIS) are plants and animals that occur in waters in which they are not native and whose introduction causes or is likely to cause economic or environmental damage or harm to human health. AIS have a negative impact on the waterway, its native species, and recreational and commercial uses of the waterway. As responsible boaters and citizens, each boat owner should do their part to prevent the spread of these aquatic hitchhikers.

In many cases, it is also required by law. Check local regulations for any waterway where you will boat.

After each boating trip, follow these three simple steps before you leave the water access to stop the spread of AIS: Clean, Drain, and Dry. This is the boater's way to help protect the environment from the damage that AIS can cause.

Clean

- Inspect and remove all aquatic plants, animals, mud, and debris from the boat, engine, trailer, anchor, and any watersports equipment.
- Rinse, scrub or wash, as appropriate, away from storm drains, ditches, or waterways.
- Rinse watercraft, trailer, and equipment with hot water, when possible.
- Flush motor according to owner's manual.

Drain

Completely drain all water from the boat and its compartments, including but not limited to the bilge, wells, lockers, ballast tanks or bags, bait containers, engines, and outdrives.

Dry

Allow the boat to completely dry before visiting any other bodies of water. Water-borne organisms cannot survive long periods of dryness.

NOTE — Some localities may require inspection or decontamination before and/or after launching. Check state and local laws and regulations for requirements prior to traveling to go boating.

Boating Regulations and Your Responsibilities

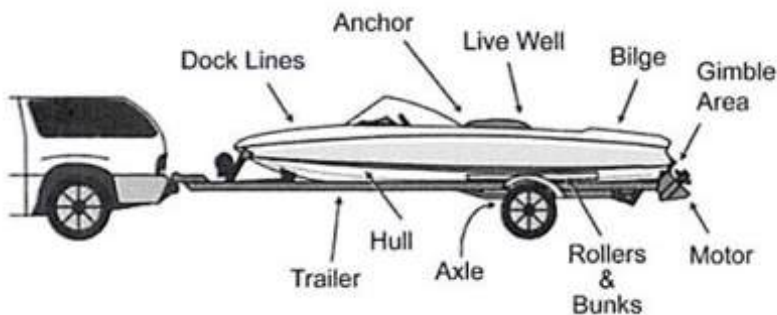

PAINTS

Boat owners are responsible for the environmental regulations that may govern the use of antifouling paint. If the boat is kept in water where marine growth is a problem, the use of antifouling paint may reduce the growth rate. Regulations may vary from state to state. Contact local and state boating authorities for specific information.

CLEANING AGENTS

Boat owners are responsible for the environmental regulations that may govern the use of cleaning agents. There are many “green” cleaner choices available for most any material on the boat. If using household cleaners, use them sparingly and never discharge them into waterways. Do not mix cleaners and be sure to use plenty of ventilation in enclosed areas. Avoid using chlorine, solvents and products that contain phosphates, as well as non-biodegradable or petroleum-based products. Regulations may vary from state to state. Contact local and state boating authorities for specific information.

EXHAUST EMISSIONS

Boat owners are responsible for the exhaust emissions from the boat. Increased exhaust (hydrocarbon) emissions, which are regulated by the EPA, pollute the water and air. Contact the dealer and the engine manufacturer for more information. Additional restrictions may apply and vary from state to state. Contact local and state boating authorities for specific information.

NOISE

Boat owners/operators are responsible for the noise the boat creates. Many state and local boating authorities enforce noise limits that may restrict engine noise, radio volume or even loud talking. Regulations may vary from state to state. Contact local and state boating authorities for specific information.

SPEED

Boat owners/operators are responsible for maintaining the boat under control at a safe speed. Many state and local boating authorities enforce speed limits. Regulations may vary from state to state. Contact local and state boating authorities for specific information.

WAKE

Boat owners/operators are responsible for the wake the boat creates. Regulations may vary from state to state. Contact local and state boating authorities for specific information, as owners/operators may be responsible for any damage or injury their wake causes. Always be alert for no-wake zones and be courteous of others while boating. Excessive and unexpected wakes can cause dangerous and even life-threatening situations.

RESTRICTED AREAS

SECURITY ZONES

Operators must avoid all waterways and areas that are restricted, such as military installations, power plants and petroleum and chemical facilities. Because of the threat of terrorism, the U.S. Coast Guard has implemented and will continue to enforce strict limits on boats near U.S. Navy and U.S. Coast Guard ships and other potential targets.

NAVAL VESSEL PROTECTION ZONES

Do not approach within 100 yards of any U.S. Naval vessel. Slow to minimum speed within 500 yards of any U.S. Naval vessel. Operators needing to approach within 100 yards to ensure a safe passage in accordance with the Navigation Rules must contact the U.S. Naval vessel or the U.S. Coast Guard escort vessel on the boat's VHF radio (channel 16) for authorization.

Boating Regulations and Your Responsibilities

COMMERCIAL SHIPPING SAFETY ZONES

Do not operate the boat near cruise liners or certain waterfront commercial installations such as ferry terminals. Observe and avoid all security zones and commercial port operations.

BRIDGES AND SHIPPING CHANNELS

Do not stop or anchor beneath bridges or in shipping channels. Operators doing so should expect to be asked to move and/or be boarded by law enforcement officials. Anchoring in these areas is dangerous for the operator and others on the water.

AMERICA'S WATERWAY WATCH

Boat operators can help the U.S. Coast Guard in keeping waterways and coastal installations safe and secure. Boat operators can do this by participating in America's Waterway Watch (AWW). Boaters reporting suspicious activities to AWW should call 877-24WATCH if noticing suspicious activity or behavior on or near the water.

In cases of immediate danger to life or property, call the U.S. Coast Guard on channel 16 VHF-FM or dial 911 for emergencies.

FISHING

Fishing can be very exciting and distracting for the operator when the action gets intense. Operators must always be conscious of the primary responsibility, which is the safe operation of the boat and the safety of passengers and other boats in the area.

Always make sure the helm is properly manned and is never left unattended while trolling. If the boat is equipped with a tower, exercise caution and sound judgment whenever someone is in the tower. Remember, weight in the tower raises the boat's center of gravity and the boat's motion is greatly exaggerated for the person in a tower.

An operator fishing in an area that is crowded with other fishing boats may have difficulty following the rules of the road. This situation can become especially difficult when many boats are trolling. Being courteous and exercising sound judgment is essential. Avoid trying to assert the right-of-way and concentrate on staying clear of other boats. Prevent the boat from becoming entangled in lines and from cutting into lines. Also keep in mind that fishing line wrapped around a propeller shaft can damage seals in the engine lower unit.

There is currently a tremendous drain on our fishing resources. Excessive fishing and hunting, as well as pollution, have strained the fish and game population. Help out by keeping only what you will eat; practice catch-and-release and obey bag limits.

MONOFILAMENT FISHING LINE

Wildlife can experience harm from becoming entangled in or ingesting monofilament fishing line if it is left in the water or on shore. Line in the water can also endanger swimmers and divers and become tangled in boat propellers, causing damage. It can last for years in water, posing a threat for a long time. Fishing line can remain a problem even if put in the trash, because birds can take it from an open bin and become entangled or it can entangle wildlife at landfills.

Many states and private boating/wildlife organizations sponsor programs to collect used line for recycling into new products. Operators who carry used line or happen upon it while boating can dispose of it in recycling bins located at many marinas, launches, tackle shops and state service centers.

CENTURION BOATS

Section 5

EMERGENCIES

Before operating the boat, review *Safety in Section 3*.

Be prepared to deal with emergencies before they happen. Try to formulate a plan for each type of emergency in advance in order to make decisions quickly and without hesitation. Precious moments lost can mean the difference between losing and saving a life.

FIRST AID / MEDICAL EMERGENCIES

Every second counts toward preventing injury or death in case of a medical emergency. Boaters must have proper training and take necessary preventive measures to properly assist in times of need. Carrying an adequate and current first aid kit is critical in the immediate response and care of someone in need of medical attention. Always have dry blankets readily accessible to help prevent hypothermia. For additional information on medical, first aid and safety training such as CPR, contact your state and local authorities, or visit the Red Cross website:

<http://www.redcross.org>.

EMERGENCY PREPARATION CHECKLIST

In addition to a safety equipment list, have an emergency checklist on board to assist in times of emergency. Use the following topics as a guideline to develop a list of emergency procedures and instructions for the use of visual and audible distress signaling devices, radios, first aid kits and all related information that could assist you or others in the event of an emergency.

LAW OF SALVAGE

If boaters require assistance while cruising in the Great Lakes, coastal or ocean waters, they should use caution **before** allowing any towing company or private agency to pass a line to the boat. The law of salvage says, among other things, *"...any vessel, if rendered assistance from a towing company or private agency, can be forced to relinquish a portion of the vessel's worth for the assistance received."* While this is very rare with recreational boats, it can happen.

Before taking the line boaters must establish that they do not agree to any salvage rights and wish to be assisted on a contract basis. Boaters must then establish the contract price and payment terms. Boaters should accept the tow line only when the captain of the company/agency acknowledges the contract price and payment. Most tow companies are reputable and post terms and pricing on their websites.

If boating in the Great Lakes, coastal or ocean waters, it is a good idea to have a membership in a national towing service. This membership can significantly reduce the costs of towing if ever needed.

FIRE AND EXPLOSION

For additional information on extinguishing fires and specific fire extinguisher requirements, see *Fire Extinguisher* on page 3-33.

 **WARNING** *Fire/Explosion Hazard: Gasoline is extremely flammable and highly explosive under certain conditions.*

- Do not smoke or allow open flames or sparks nearby when refueling.
- Do not store fuel in any containers or compartments which are not designated for fuel storage.
- Static electricity can be generated while fueling and can cause a fire or explosion. To prevent electrostatic spark when refueling, make sure the nozzle is in contact with the fill pipe at all times.
- Avoid damaging fuel lines and connectors and make sure fuel does not contact hot engine parts.
- Do not confuse the fuel fill deck plate with the water or waste fill plates, if equipped. All deck plates are properly labeled. If fuel is accidentally pumped into any other deck plate, do not attempt to pump it out. Water and waste pumps are not designed to pump fuel and a fire or explosion could result. Contact the dealer to have the fuel professionally removed.
- USCG-approved fire extinguishers are required on all Class I, II and III boats.

A fire or explosion may occur when least expected. The decision to abandon the boat or stay to fight the fire is difficult and depends on many factors. Formulate a fire plan in advance to make that decision quickly and without hesitation. Keep in mind the following guidelines:



KC-0252C-A

- Many fires are the result of gasoline and oil accumulating in the bilge, careless fueling practices and electrical problems. In the event of a fire, try to stop the boat and turn off the engine as quickly and safely as possible. Immediately use a fire extinguisher at the base of the flames in a sweeping motion to reduce or extinguish the fire. Ensure that all passengers are safe from immediate danger and are wearing life jackets. If the fire is located in the engine compartment (if equipped), make sure the bilge blower (if equipped) is off and do not open the engine cover.
- Once the fire is extinguished, check for other immediate fire threats and personal injuries and call for assistance immediately.
- If you are unable to easily extinguish the fire, or if the fire is uncontrollable, attempt to get yourself and all passengers off the boat and into the water. If possible, ensure that all passengers are wearing life jackets or have access to one by the time they are in the water. Before leaving the boat, if possible, verify that there is no immediate danger of fuel sitting or burning on the water's surface where you and your passengers will be floating. Immediately swim to a safe position upwind from the boat and use distress signals to get assistance.

MAN OVERBOARD (MOB)

A high percentage of boating fatalities are the result of people falling overboard, many of whom were not wearing life jackets. If someone falls into the water unexpectedly, react quickly, as every second counts toward preventing injury or death. Keep these guidelines in mind:

- Brief passengers before leaving the dock on the proper procedures should someone fall overboard. Add this briefing to the passenger safety equipment overview.
- At the first sign that a person has fallen overboard, loudly yell "man overboard" and state which side of the boat such as "man overboard—port!" In heavy seas, throw a floatable item toward the MOB as quickly as possible to serve as a marker.

Section 5

- The operator should immediately reduce speed and determine whether or not to come to a full stop or circle around.
 - If stopped, throw a flotation device (a throwable type is best, but any can be used) to the victim, shut down the engines, and throw the victim a line if necessary.
 - If circling around, assign one passenger to throw a flotation device as a marker, keep the victim in sight and continuously point to the victim. Carefully navigate back to the victim, staying at a safe distance, and position the boat safely to retrieve the victim. Keep current, wind and waves in mind so the victim drifts toward the boat. Shut down the engines and throw the victim a line if necessary.
- Move passengers to the rescue side of the boat to assist the victim back into the boat.
- Avoid going into the water to assist the victim unless there is no other way to retrieve the victim. If a rescuer must go into the water, the rescuer should be wearing a life jacket. The rescuer should also be prepared for the possibility of being pulled under water by the victim if the victim is panicking.

CAPSIZING AND FLOODING

A boat may capsize or flood when least expected. Formulate a plan in advance in case of capsizing or flooding. Review the following guidelines:

- If the boat capsizes, locate all passengers and guide them to a safe flotation device or the forward hull if the boat is floating upside down.
- If possible, provide life jackets to all persons in the water and assess them for alertness and injuries.
- **STAY WITH THE BOAT!** Climb up on the hull and try to get assistance.
- Do not try to swim to shore, as it can be farther than it appears.

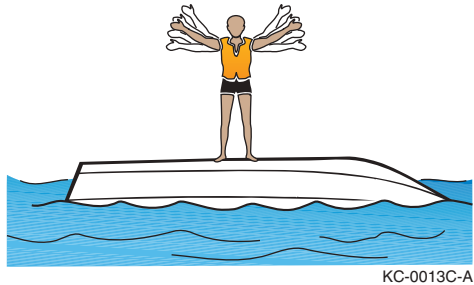

KC-0013C-A

If the boat starts to flood, slow the boat to a safe speed and stop as quickly as possible. Activate the bilge pump(s) immediately. Try to locate the cause of the flooding. If the cause is not readily apparent or not easily corrected, head for shore or shallow water as quickly as possible and call for help.

RUNNING AGROUND

When a boat runs aground, the stop is usually abrupt. Because passengers are not secured to a seat, abruptly stopping a boat while in motion can cause serious personal injury or even death. First, turn off the engine(s) immediately, locate all passengers and attend to any injuries, calling for emergency assistance as needed. Then, assess the damage to the boat and determine if there are any other immediate threats such as water leaking into the boat, or fuel or flammable materials leaking into the water or inside the boat. Immediately call for assistance if threats exist that could endanger the safety of passengers.

If there are no immediate safety threats to passengers and the boat is not damaged, attempt to propel it away from the obstacle. If the engine or drive system has been damaged and the engine restarts, be aware of excessive vibrations or uncommon noises, which usually indicate damage to the drive system. If this is the case, it is not safe to proceed. Call for emergency or professional towing assistance immediately.

 **WARNING** *Personal Injury Hazard: DO NOT attach tow lines to cleats, watersport line point, wake tower, or eyes used for docking; use only designated strong points. Death or serious injury could occur if lines and/or hardware fail while they are under extreme tension.*

If the engine restarts and the boat can be navigated safely back to port, proceed slowly to port and be ready to call for emergency assistance if needed. Even if the boat and engine appear to be in good operating condition after running aground, have the boat inspected by a qualified marine technician BEFORE returning it to service. Damage may have occurred that is not obvious to you as an operator.

DANGEROUS WEATHER

Take special precautions when encountering or operating in dangerous or hazardous weather conditions.

See the *Severe Weather* section of this manual for additional information.

ENGINE OR BOAT SYSTEM FAILURE

In the event of an engine or boat system failure and when not in immediate danger, try to troubleshoot or identify the problem before calling for assistance.

See the *Troubleshooting* section of this manual for additional information.

ACCIDENTS, COLLISIONS AND GIVING ASSISTANCE

A collision or accident may occur when least expected. Formulate a course of action in advance in case of a collision or accident. Keep in mind the following guidelines:

- If an accident or collision occurs involving the boat, locate all passengers first and verify and secure their safety. Check for injuries and provide all passengers with a flotation device.
- After determining that passengers are not in danger, provide assistance to passengers on the other boat.
- Immediately call for help and then assess the damage to the boats. Render necessary assistance to prevent further damage or personal injury.

The USCG requires the owner/operator of a boat involved in an accident to report the incident immediately to the proper marine law enforcement agency for the state in which the accident occurred.

See the *Reporting Accidents* section of this manual for additional information.

An operator who witnesses or is aware of an accident or collision while boating must report it immediately and provide assistance.

Operators seeing a distress signal or suspecting a boat is in trouble must assume it is a real emergency and render assistance immediately. After determining that a real emergency exists, call for help immediately and then provide assistance to all passengers to ensure their safety.

TOWING ON THE WATER

In situations where an operator is asked to tow or be towed for any reason, assess the situation and try to contact a professional towing service or other emergency assistance first. When encountering a boat in distress, always offer emergency or safety assistance and/or call for assistance for the distressed parties if necessary. Towing or being towed presents an increased risk of personal injury and boat damage.

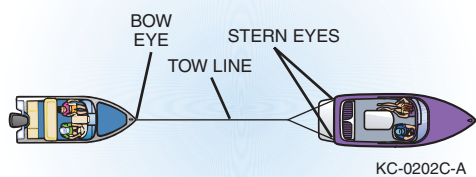

WARNING *Personal Injury Hazard: DO NOT attach tow lines to cleats, watersport line point, wake tower, or eyes used for docking; use only designated strong points. Death or serious injury could occur if lines and/or hardware fail while they are under extreme tension.*

Follow these guidelines when towing or being towed:

- Use extreme caution when throwing weighted lines to a boat in distress. When in rough seas, use a light throwing line with a weight secured on the throwing end and a heavier towing line secured to the other end.
- Never attempt to tow a boat larger or heavier than your own.
- Never attempt to tow a grounded, damaged or capsized boat.
- Use a tow line that is rated at least four times the gross weight of the boat being towed.
- Make sure tow lines are in good condition and are free of damage, cuts or abrasions.
- Attach a tow line to the designated strong point on the disabled boat. Never attach a tow line to any point on the disabled boat other than the designated strong point. Strong points are typically the bow and stern eyes on boats under 26' and are usually labeled.
- When attaching to the stern strong points, wrap the tow line with chafing gear where it rubs against the boat or any corners.
- Leave at least two boat lengths between the boats for adequate movement.
- Never allow anyone to be in line with the tow line. If the line breaks, pulls free or the hardware fails, dangerous recoil could occur, resulting in severe injury or death to anyone in its path.
- Adjust the tow line to match wave action. Keep the boats on the crest or in the trough of the waves at the same time. In protected, calm waters, shorten the line for better handling.
- Tow at moderate speed, allowing for adverse wind and wave conditions.
- Have the operator of the towed boat steer with you if possible.
- Have a person on the tow boat watch the disabled vehicle and, if necessary, be available to signal the operator of the disabled boat.

Check with local and state authorities prior to towing for additional regulations and restrictions on towing other boats or equipment.

HURRICANE AND SEVERE WEATHER PREPAREDNESS

If keeping the boat in a region susceptible to hurricanes or severe weather (such as in the Great Lakes), have a well-thought-out plan for the boat long before the season starts. Consider the following:

- Boaters new to the area should talk to neighbors and local officials on what to expect.
- Boaters should talk to the dealer and marina about supplies, equipment and services available.

- Assemble the boat, contacts and insurance information and copy documents for safekeeping.
- If keeping the boat on the water, prepare a hurricane mooring package with extra lines, fenders and chafing protectors, as it is usually the boat owner's responsibility to provide mooring gear in a marina. Plan on doubling the normal lines (bow, stern and spring) and fenders as a minimum. Remember, once a hurricane watch is posted, the local supply of lines and fenders will be quickly depleted.
- Remove electronics, canvas and loose items such as fighting chairs.
- Remove flammable, explosive or hazardous materials.

PROTECTING THE BOAT FROM THEFT

Thefts of boats, propulsion units and electronics are on the rise due to the high values and easy resale. While thieves still target boats on trailers at homes or on lake properties, marinas, storage facilities and dealerships are now being targeted because of the concentration of high-quality outboards and electronics available. Consider the following to make it difficult for thieves:

- Remove expensive electronics or cover with a sturdy, lockable cover.
- Use locking devices on outboard motor mounts and propellers.
- Use security fasteners that require a special tool for removal when mounting devices.
- Survey the marina or storage facility for obvious security lapses. Discuss concerns with personnel or find a new location.
- Talk to neighbors at home or the marina/storage facility and provide them with a cell phone number and other contact information.
- If leaving the boat in the water, install a boat monitoring system with GPS tracking. Many propulsion unit manufacturers now offer this as an option on boats with electronic controls.
- Consult an insurance agent and local authorities for more recommendations.

CENTURION BOATS

Section 6

OPERATING IN HAZARDOUS CONDITIONS

Before operating the boat, review *Safety in Section 3*.

SEVERE WEATHER

Getting caught in severe weather can be dangerous and even fatal. Check with local weather stations, the USCG or weather-service broadcasts (162.55 or 162.40 MHz) for the latest conditions. Check the weather not only before you go out on the water, but also periodically while you are on the water. Consult the following websites for weather information:

- www.weather.com
- www.weather.gov
- www.navcen.uscg.gov

Enable National Oceanic and Atmospheric Administration (NOAA) weather alerts on radios, phones and other electronic devices for advance warnings. If weather is approaching, instruct all passengers to wear a life jacket; close all windows, hatches and doors; remain seated; use handholds and seek shelter in a safe harbor.

STORM CONDITIONS

Take the following precautions if operating the boat in storm conditions:

- Have all occupants wear life jackets.
- Turn on navigation lights.
- Locate and have inclement weather gear and safety equipment ready.
- Mark or identify the boat's position.
- Close all ports, stow all gear and secure any loose equipment on deck.
- Reduce speed and head for port or a safe, easily reachable place.
- Keep a lookout for debris and obstructions in the water.

Section 6

- When possible, head into the waves at a 45-degree angle. Allowing high waves to strike the side of the boat may cause it to capsize or swamp.
- If losing power, keep the boat headed into the waves by rigging a sea anchor off the bow.
- If a storm cell with lightning cannot be avoided, lower antenna and take down fishing poles.

FOG CONDITIONS

Avoid operating the boat in foggy weather, if possible. Operators encountering fog conditions should return to port immediately. Also, take the following precautions:

- Reduce speed to a safe speed or idle.
- Take bearings and log the course and speed before the fog sets in. Use of a GPS is recommended.
- Have all occupants wear life jackets.
- Assign lookouts to the bow and stern to keep watch and listen.
- While navigating in fog, sound a five-second blast from the horn or whistle once every two minutes to alert other boaters of your position.
- If it is unsafe to continue navigating the boat, quickly find the best position to anchor. Sound a five-second blast from the horn or whistle once every minute while anchored to alert other boaters of your position.

REDUCED VISIBILITY

Natural environments and inclement weather can cause reduced visibility. Storm condition hazards can be compounded by reduced visibility while on the water. Always use common sense and take safety precautions if operating the boat in reduced visibility conditions.

COLD WEATHER

Avoid operating the boat in cold water or weather conditions, and never operate in frozen or icy waters. Operating in these conditions significantly increases the risk of serious injury or death. Boating in these conditions can lead to cold-water immersion, shock or hypothermia. Weather conditions may hinder emergency rescue or assistance, and cold weather poses potential problems for onboard equipment, as well as the engine. See the *Engine Operator's Manual* and the equipment manufacturer's instructions for operating in cold weather.

WATER HAZARDS

Every waterway poses hazards that operators must be aware of and avoid. These hazards include shallow water, rocks, tree stumps, sandbars and submerged/semi-submerged cables and pipes. Ask local authorities and other boaters for information and consult a marine chart when boating on unfamiliar waters. As a boat operator, try to avoid all hazards, known and unknown.

AQUATIC VEGETATION / WEEDS

Operating in weeded areas can be hazardous. Aquatic vegetation can be a threat to the boat's drive system. Vegetation and weeds can wrap around the propeller, causing loss of propulsion and steering control. They may also restrict the engine water cooling intake, causing the engine to overheat. Avoid operating in or near vegetation. If restricted because of vegetation, stop the engine. See the *Engine Operator's Manual* for recommendations on the removal of vegetation from the propeller and water cooling intake ports. Be extremely careful and never get into the water when clearing the propeller. Stay out of the water in highly congested vegetative areas, which can severely restrict your mobility and create a life-threatening situation.

NOTICE

Vegetation can sometimes be removed by shifting to NEUTRAL, pausing a moment, then shifting to REVERSE to unwind the vegetation from the propeller.

DAMS AND SPILLWAYS

The waterways around dams and spillways are extremely hazardous. Dams and spillways are subject to rapid water flow changes, and may have floating and sunken debris in the nearby water. These areas are often marked as restricted, and it is best to always stay clear of them.

SHALLOW WATER OPERATION



WARNING

Collision Hazard: Use caution in shallow water or where underwater/floating objects may be present. Hitting an object at high speed or severe angle can seriously injure people and damage the boat.

Operating in shallow water presents a number of hazards. Sandbars in narrow inlets are constantly shifting, making it difficult to mark them with buoys. Sandbars are sometimes indicated by waves as they form into breakers when passing over the sandbar. In coastal areas, tides can affect water level as much as 30 feet (9 meters). Check with local marinas or Coast Guard stations for tide tables and current charts.

MARKERS, WARNINGS AND ADVISORIES

Find out from local authorities if hazards exist in areas where you intend to navigate, and know how these hazards are marked. You must also recognize flag designs that indicate hazards or activities that are present and keep well clear of those areas. Always watch for swimmers and stay clear of all swimming areas, marked or unmarked.



KC-0015C-B

Become familiar with navigation markers, which identify navigable routes and indicate water hazards. Always stay within marked boundaries and steer clear of hazards.

Flags and indicators are markers of potential emergencies and hazards. Become familiar with these flags and indicators. Additionally, understand your responsibilities when operating at these times and in these areas.

BOAT FLAGS

DIVERS FLAG



USED BY RECREATIONAL DIVERS - INDICATES DIVER'S POSITION

ALPHA FLAG



WORLDWIDE VESSELS ENGAGED IN DIVING OPERATIONS - DOES NOT INDICATE DIVER'S POSITION

DISTRESS FLAG



INDICATES FELLOW BOATER IS IN NEED OF ASSISTANCE

SKIER DOWN FLAG









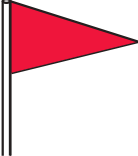

INDICATES SKIER IS DOWN

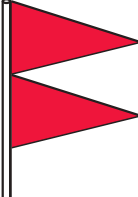
KCB-0013

Storm warning advisory flags and indicators alert boaters to impending weather conditions. Become familiar with these flags and indicators and understand the potential hazards associated with operating in these conditions.

HARBOR FLAGS AND INDICATORS

DAYTIME WARNING	DESCRIPTION	NIGHTTIME WARNING
	Small Craft Advisory - Winds greater than 18 knots, sustained for two hours or more or hazardous wave conditions. Following a storm, hazardous wave conditions can persist long after the high winds have subsided.	
	Gale Warning - Sustained winds (2 or more hours), of 34-47 knots.	
	Storm Warning - Sustained winds of 48 knots or greater.	
	Hurricane Warning - Forecast winds of 64 knots and above. Displayed only in connection with a hurricane.	

 Actual Signal in red

KC-0371C

This Page Intentionally Left Blank

CENTURION BOATS

Section 7

NAVIGATION RULES AND AIDS

Before operating the boat, review *Safety in Section 3*.

The following information outlines basic navigational rules. Boating regulations are enforced by USCG, state and local authorities. You are subject to marine navigation regulations for both federal and state waterways. For more information, contact the USCG, state and local marine authorities. The navigational rules for U.S. waterways can be found in the “Navigational Rules” publication. This publication can be found at most marine supply stores, or you may contact the USCG or visit:

www.navcen.uscg.gov to view or download the publication.

RULES OF THE ROAD

RIGHT-OF-WAY

Boats with less maneuverability have right-of-way over more agile boats. You must stay clear of a boat with right-of-way. Examples of boats with right-of-way are:

- Boats aground or not under command
- Boats with restricted maneuverability
- Boats engaged in fishing
- Non-motor boats (having no power propulsion), i.e., rowboats, paddle boats, canoes and sailboats

Small pleasure boats must yield right-of-way to large commercial boats in narrow channels. A boat with right-of-way is sometimes referred to as the privileged boat.

THE GENERAL PRUDENTIAL RULE

The general prudential rule regarding right-of-way is if a collision appears unavoidable, neither boat has right-of-way. Both boats must act to avoid collision.

AUDIBLE SIGNALS

It is not necessary to sound a signal every time a boat is nearby. It is typical for commercial boat operators to signal their intention, using a whistle, horn or bell, to avoid potentially confusing or hazardous situations. Privileged boat operators customarily signal first, then the yielding boat operators return the same signal to acknowledge they understand and will comply. Use the danger signal (five or more short, rapid blasts) if intent is not clear.

Use the following signal blasts early enough so other boaters notice and understand them:

AUDIBLE DISTRESS SIGNAL	DEFINITION
One long blast	Warning signal (coming out of slip or passing astern)
One short blast	Pass on port side
Two short blasts	Pass on starboard side
Three short blasts	Engine(s) in reverse
Five or more short blasts	Danger signal

OVERTAKING / PASSING

The boat overtaking or passing must yield right-of-way to the boat being passed. The overtaking boat must make any adjustments necessary to keep out of the way of the boat being passed. The boat being passed has the right-of-way and must hold its course and speed.

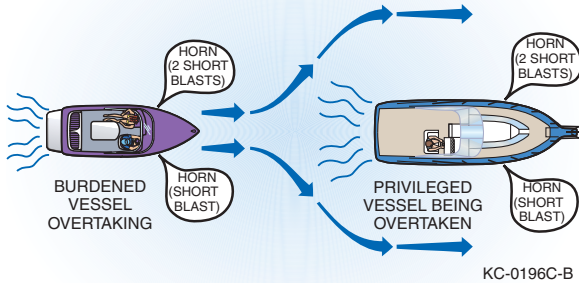

MEETING HEAD-ON

When two boats meet head-on, neither boat has the right-of-way. Both boats should decrease speed, turn to the right and pass port to port. If, however, both boats are on the left side of a channel, each vessel should sound two short horn blasts and pass starboard to starboard.

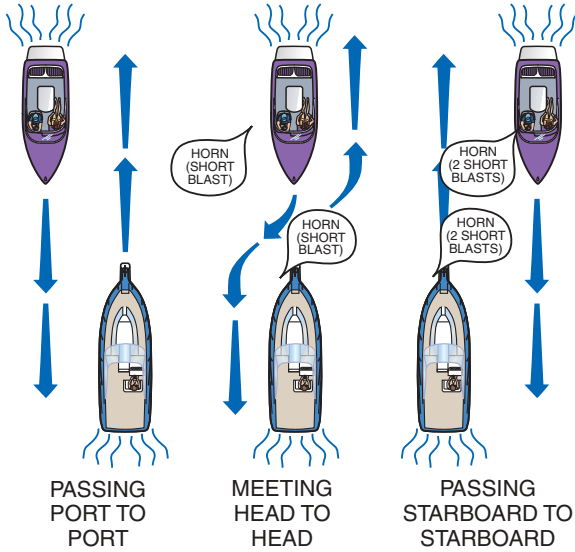

KC-0195C-B

CROSSING

In crossing situations, the boat to the right from the 12 o'clock to the 4 o'clock position has the right-of-way and must hold course and speed. The boat without right-of-way must yield and pass to the stern of the privileged boat. Boats going up and down a river have the right-of-way over boats crossing the river.

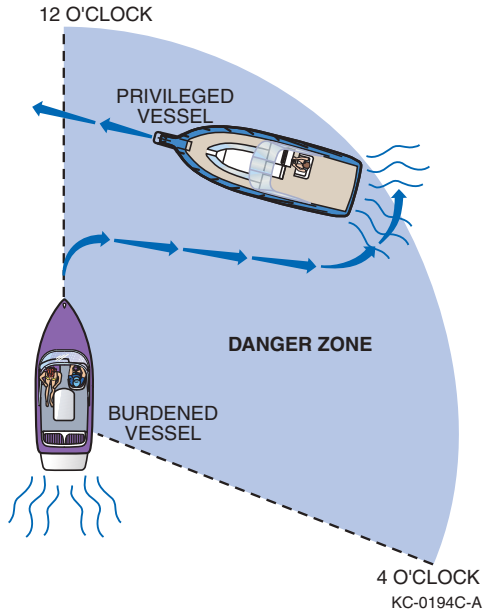

AIDS TO NAVIGATION

Learn to recognize the different buoys and day markers; they are the signposts of the waterways. The United States Aids to Navigation System (USATONS) is the primary marking system used on inland water, coastal waters and rivers. This system is maintained by the USCG.

There are two other navigation marking system variations boaters must follow in the United States:

- Western Rivers Marking System – When on the Mississippi River, tributaries above Baton Rouge, and several other rivers that flow toward the Gulf of Mexico.
- Intracoastal Waterway (ICW) – Runs just inland and parallel to the Atlantic Ocean and Gulf coasts from Manasquan, New Jersey, to the Mexican border. *Since ICW routes may travel next to non-ICW routes in opposing directions, navigate by the yellow symbols when following the ICW.*

Both systems are similar to USATONS but have subtle differences that must be understood. If you boat in these areas, visit www.uscgboating.org for navigation rules.

Navigational aids are designed and placed accordingly to help you navigate safely on the water. Learn to recognize the different buoys and day markers.

The following information is based on the USATONS. For further information, contact the USCG and state and local marine authorities. Also visit www.uscgboating.org for navigation rules.

The USATONS uses buoys, beacons and minor lights as markers.

NEVER tie or anchor to a navigational aid. This action is unlawful and dangerous to you, your boat and other boaters.

NEVER move or damage a navigational aid. This action is unlawful and dangerous for other boaters.

BUOYS

Most anchored floating markers are generally referred to as buoys. Buoys have many uses and color schemes, and can vary in size and shape. The most commonly used buoy colors are white, red, green, yellow and black. Buoys may be unlighted or lighted. Some are audible; others have both an audible and a visual signal. Lights, bells and horns on buoys aid in night boating or poor visibility conditions. Buoys with unique light-flashing characteristics are identified on nautical charts with the specific flashing pattern.

Navigation Rules and Aids

Become familiar with the specific buoys used in the waters where you are boating. Contact local authorities for specific information and/or navigational aid charts for your waterways.

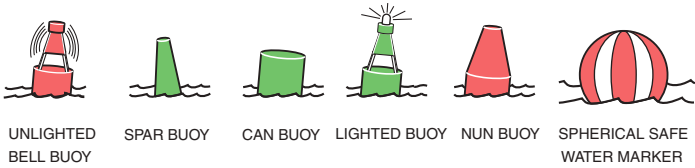

KC-0052C-B

MOORING BUOYS

The only buoys you are permitted to moor to are mooring buoys. Mooring buoys are white with a blue horizontal stripe. Check with local authorities before deploying a permanent mooring buoy. Mooring to a navigation buoy, regulatory markers or lateral markers is illegal.



WHITE WITH BLUE BAND
MAY SHOW WHITE REFLECTOR OR LIGHT

KC-0020C-A

DAYMARKS / DAYBOARDS

Daymarks or dayboards are fixed visual markers in the water. The markers are commonly attached to a post or piling and are sometimes accompanied by a light. Daymarks are either red or green and are usually triangular- or square-shaped, though their shapes can vary. Daymarks often display numbers, which act as navigation guides. Red daymarks are usually triangular and sometimes show an odd number. Green daymarks are usually square and sometimes show an even number. The numbers on the markers are sequential and increase from seaward.



STARBOARD DAY MARKER



PORT DAY MARKER

KC-0021C-A

LIGHTS AND LIGHTED STRUCTURES

Maneuvering a boat at night can be dangerous and confusing. To aid boaters with navigation and to warn of hazards, the USCG and state and local authorities maintain a variety of light structures. Some light structures are equipped with radio beacons, radar reflectors and/or fog signals.

Minor Lights

Minor lights are colored according to the buoyage marking system in use. They are similar to lighted buoys, except they are usually higher and on more stable platforms to increase visibility. Most minor lights are part of a series to mark a channel, river, or harbor and fairways.

Range Lights

Range lights are usually visible in one direction and help a boat operator navigate safely. Steering a course to keep range lights arranged in a line (one on top of the other) will help guide a boat through a channel.

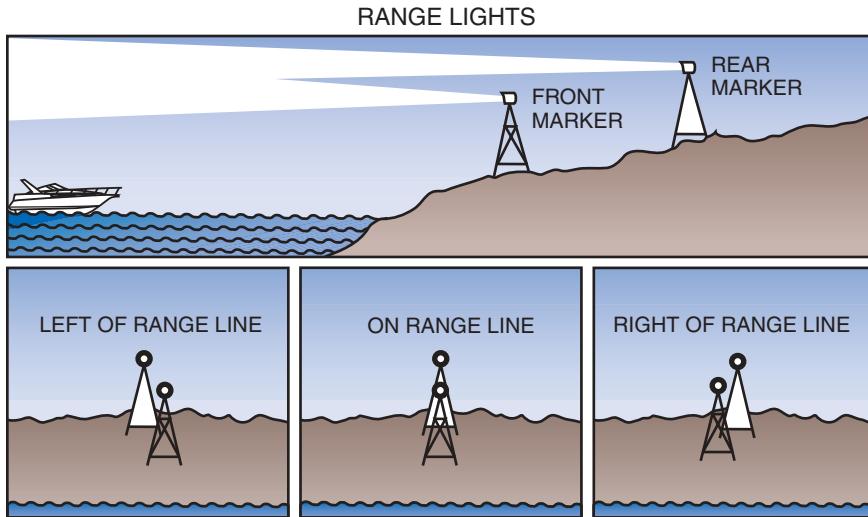

KC-0022C-A

Lighthouses

Lighthouses can be found at harbor entrances, prominent headlands, isolated danger areas and along the coasts. These striped or patterned structures have unique flashing signals, which help boaters identify them.

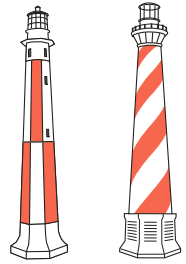

KC-0023C-B

MARKERS

Seven (7) types of markers are used to assist the boat operator:

- Regulatory
- Range
- Special
- Lateral
- Safe Water
- Preferred Channel
- Isolated Danger

Regulatory Markers

Regulatory markers are used to display information or indicate danger. Regulatory markers can be fixed visual markers or anchored floating buoys.

Fixed visual markers are usually white with orange geometric shapes that display information. Anchored floating buoys are white cylinder-shaped buoys with orange bands at the top and orange geometric shapes that may display information.

Following are the various orange geometric shapes used on these markers:

- Diamond – Indicates danger
- Diamond with cross marks inside – Indicates that a boater must keep away
- Circle – Indicates a controlled area or speed limit
- Square – Displays important information



DANGER



BOATS
KEEP OUT



CONTROLLED
AREA



INFORMATION

KC-0244C-A

Range Markers

Range markers have many color schemes, may have numbers or letters and may be lighted or unlighted. They are placed in pairs within close distance of each other. They are commonly used in channels to guide boats safely through the center or safe line of navigation. Keep range markers visually in line with each other while navigating the waterway to avoid obstacles or other invisible dangers.

Special Markers

Special markers are yellow and come in various styles and shapes. Lighted and unlighted daymarks and buoys vary in function. Many are used to display information and navigational direction rules. The most common special markers are those used in intercoastal waterways. Contact your state and local authorities for more information on special markers used in your boating area.

Lateral Markers

Lateral markers are used to mark the sides of navigable channels. They can be buoys, daymarks or minor lights, and are red and green in color. They can be lighted or unlighted and may or may not have numbers.

The basic nautical rule of lateral markers is the phrase “Red, Right, Returning.”

The term “sea” generally refers to the ocean or a large body of water. “Seaward” refers to traveling or pointing toward the sea or large body of water. “From seaward” refers to traveling from the sea or a large body of water inland or toward a smaller body of water.

When traveling seaward – keep red markers to your port (left) and green markers to your starboard (right).

When returning from seaward – keep red markers to your starboard (right) and green markers to your port (left).

Navigation Rules and Aids

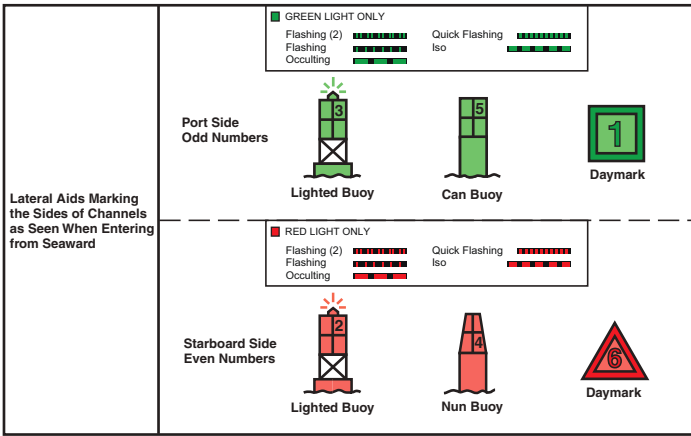

KC-0054C-A

Safe Water Markers

Fairways and mid-channels may be marked with safe water markers or buoys. These markers indicate safe water all around. Safe water markers are red and white with vertical stripes, and are round or have a red spherical top mark.

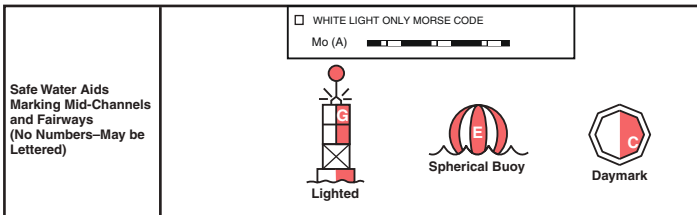

KC-0055C-A

Other Special Signs and Markers

Various signs and markers are used throughout U.S. waterways for different purposes. In Florida, special signs are used to warn of “manatee” areas. These signs help to control speed and/or restrict areas from boating to conserve this endangered species. As a boat owner and operator, be aware of special information and markers on the waterways. Contact your state and local authorities for more information on local restricted or controlled areas and their markers.

Preferred Channel Markers

Obstructions, channel junctions and preferred channels are marked with red and green horizontally striped can and nun-style buoys. The top band color indicates the preferred path to take. Use these markers in the same manner as lateral markers to follow preferred channels.

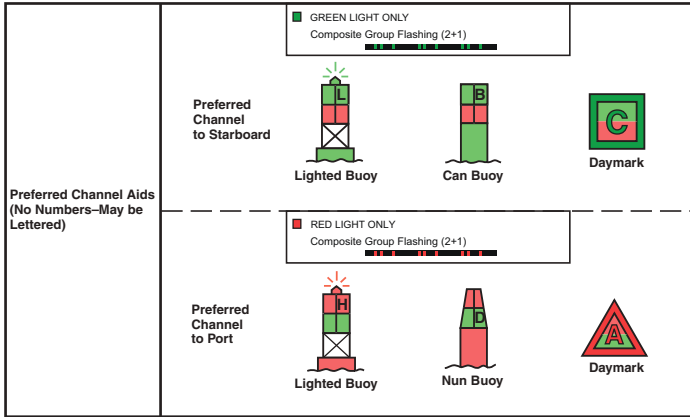

KC-0056C-A

Isolated Danger Markers

Isolated danger markers indicate an isolated danger which may be passed on all sides. These markers are black with one or more broad horizontal red bands and are equipped with a top mark of two black spheres, one above the other. On inland waters, a buoy with alternating vertical black and white stripes may be used to indicate that an obstruction or other danger exists between the buoy and the nearest shore. Do not pass between the buoy and the shore.

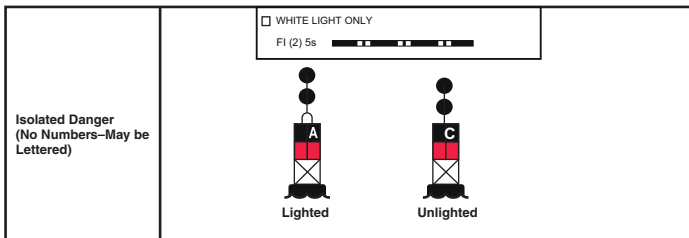

KC-0057C-A

NAVIGATIONAL LIGHTS AND NIGHT OPERATION

Navigational lights are intended to alert other boats to your presence and course and their use is essential to boating safety and the prevention of collisions. Knowledge of navigation lights is necessary for the boat operator.

Regulations require that navigational lights be clearly lit and properly displayed at all times between sunset and sunrise, and always when operating in reduced visibility. Where applicable, lights must appear on the sides, stern, masthead and all-around positions. While underway, especially in congested areas, turn off any show lighting and lighted accessories.

All navigational rules apply at night, but speed is restricted on many waterways. Night boaters must operate at a slow, safe speed and stay clear of all boats, regardless of which boat has right-of-way.

Protect your night vision by avoiding bright lights and dimming courtesy lights. If possible, have a passenger help keep watch for other boats, water hazards, and aids to navigation.

The size, speed and direction of other boats are determined at night by white, green and red running lights.

- A green light indicates the starboard side of the boat. Generally, if you see a green light on another boat, you have the right-of-way. Hold your course.
- A red light indicates the port side of the boat. Generally, if you see a red light on another boat, they have right-of-way and you must yield your course.
- If you see both red and green lights, this indicates the boat is pointed towards you. Reduce speed and give a wide berth, usually on your port.
- A white light alone with no visible red or green lights indicates a boat at anchor and not making headway or a non-powered craft. Reduce speed and give a wide berth.

This Page Intentionally Left Blank

CENTURION BOATS

Section 8

HELM AND CONTROLS

HELM

The helm contains the dashboard for information display as well as controls and switches for boat operation. The following basic information may not apply to your specific boat. This section may not cover all gauges on your boat.

See the *Engine Operator's Manual* or equipment manufacturer's supplied information on the use and operation of the unique gauges and instruments. Some models may be equipped with a multi-gauge instrument which integrates the functions of several single gauges.

Gauges are visual indicators that help you monitor various system and component operation parameters. Gauges usually have lights integrated into them for visual clarity when operating at night.

Section 8

Centurion Ri Dash

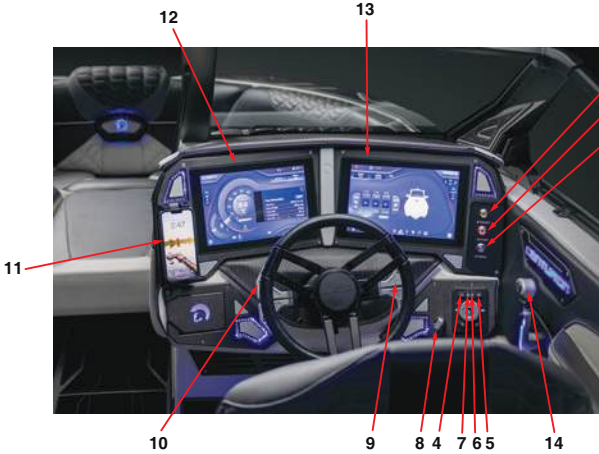

- 1: Start Button
- 2: Stop Button
- 3: Horn Button
- 4: Bilge Button
- 5: Blower Button
- 6: Anchor Button
- 7: Navigation Button
- 8: Main Power/Key
- 9: Cruise Control
- 10: Stinger Control
- 11: Phone Holder/ Charge
- 12: Left Display
- 13: Right Display
- 14: Throttle

Centurion Nv Dash

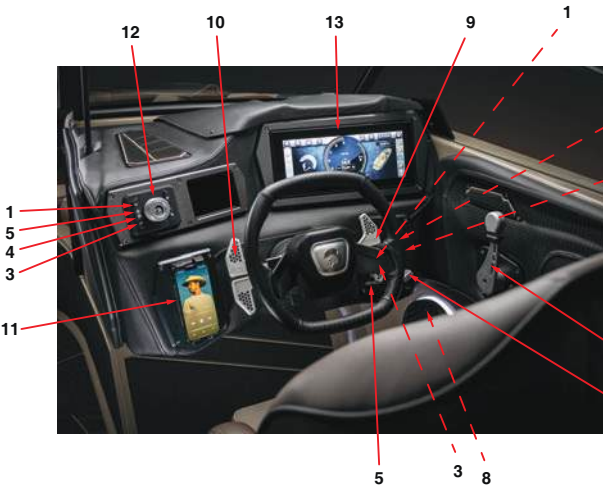

- 1: Bilge Button
- 2: Horn Button
- 3: Blower Button
- 4: Navigation Button
- 5: Anchor Button
- 6: Main Power/Key
- 7: Throttle
- 8: USB Plug
- 9: Cruise Control
- 10: Stinger Control
- 11: Phone Holder/ Charge
- 12: Stereo Control
- 13: Display

Centurion Fe Dash

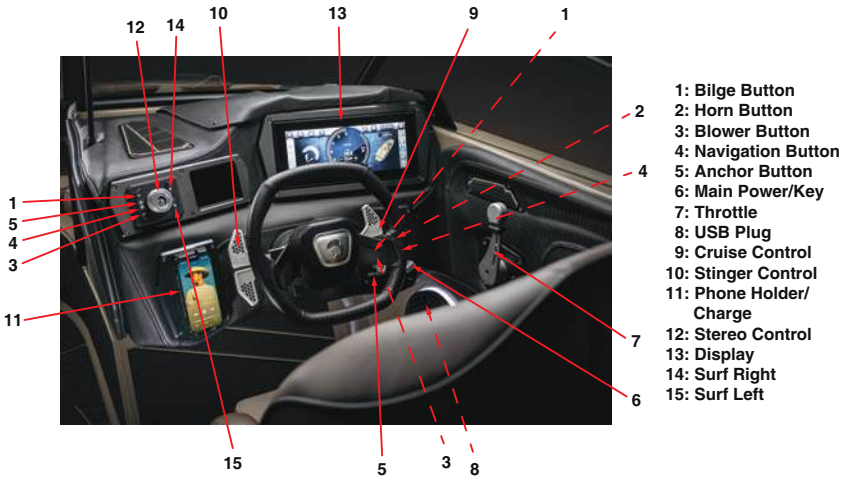

Control System Gauge

Your boat may be equipped with an optional speed control system. (Control systems and indicators may vary.) The speed control system can be used to set constant boat speeds for wakeboarding, waterskiing or wakesurfing. The system may operate in either a speed or RPM mode to control the speed at the setting you prefer. See the *Touch Vision II System and Side-by-Side touch screen* in your *Owner's Information Kit* for proper setup and operation before use.

SWITCHES AND BREAKERS

The number and type of switches and circuit breakers on your boat will vary by model and options. The following is a general reference for typical layouts.

OBSERVER SEAT STORAGE COMPARTMENT

- **Battery Switch** - makes or breaks electrical power from the battery to all boat systems except the Bilge Pump.
- **Buss Switch** - makes or breaks electrical power from the battery to the network buss.
- **Bilge Pump Circuit Breaker** - disconnects power to the bilge pump should an overload occur. If the bilge pump does not work, check for the cause and press to reset.
- **Digital Switch Breaker** - disconnects power to the helm switch panels should an overload occur. If a switch does not work, check for the cause and press to reset.

Battery Management Center



POWER SWITCH PANEL

The power switch panel is located at the helm and uses a key switch to turn power to dash and controls ON and OFF.

- **Power Switch** - makes or breaks electrical power from the battery to the helm.
- **Kill Switch** - an important safety feature that uses a lanyard attached between the switch and the operator to prevent a runaway boat situation should the operator move from the helm or get thrown from the boat. Refer to Section 3 Safety for more information.
- **12 VDC Accessory Port** - use for standard 12 volt accessories.

RI SWITCH PANEL

- **Start** - press and hold to start engine.
- **Stop** - press and release to stop engine.
- **Horn** - press and hold to activate horn.
- **Bilge** - press and release to activate bilge pump. Press and release again to turn pump off.
- **Blower** - press and release to activate blower. Press and release again to turn blower off.
- **Anchor** - press and release to activate anchor light. Press and release again to turn off lights.
- **Nav** - press and release to activate navigation lights. Press and release again to turn off lights.
- **Main Power Switch** - turn key to connect or disconnect electrical power from the battery to the helm.



NV SWITCH PANEL

- **Bilge** - press and release to activate bilge pump. Press and release again to turn pump off.
- **Horn** - press and hold to activate horn.
- **Blower** - press and release to activate blower. Press and release again to turn blower off.
- **Navigation** - press and release to activate navigation lights.
- **Anchor** - press and release to activate anchor lights.
- **Key Switch** - rotate clockwise and hold to start engine. Rotate counterclockwise and release to stop engine.



FE SWITCH PANEL

- **Bilge** - press and release to activate bilge pump. Press and release again to turn pump off.
- **Horn** - press and hold to activate horn.
- **Blower** - press and release to activate blower. Press and release again to turn blower off.
- **Nav** - press and release to activate navigation lights.
- **Anchor** - press and release to activate anchor lights.
- **Key Switch** - rotate clockwise and hold to start engine. Rotate counterclockwise and release to stop engine.



ENGINE EMERGENCY STOP SWITCH AND LANYARD

The engine emergency stop switch controls the engine ignition ON/OFF. This safety device shuts the engine off immediately and prevents the boat from becoming a runaway if the operator is accidentally thrown from the seat or away from the helm.

Typical Emergency Stop Switch and Lanyard



Whenever your boat's engine is on, physically secure one end of the emergency stop switch lanyard to the emergency stop switch and the other to the boat operator. If the operator is thrown from the seat or moves too far from the helm, the lanyard will disconnect from the switch, activating the switch to turn off the engine.

- Never remove or modify the engine emergency stop switch and/or lanyard.
- Always keep the lanyard free from obstructions that could interfere with its operation.
- Always check the switch for proper operation. With the engine running, pull the lanyard. If the engine does not stop, have the switch repaired before operating your boat further.
- Never operate your boat if the engine emergency stop switch does not work.

⚠ WARNING *Removing the engine stop switch and/or the lanyard can cause loss of control. See Safety Precautions in the Safety Section of this manual for more details.*

NEUTRAL START SAFETY SWITCH (START-IN-GEAR PREVENTION)

The neutral start safety switch provides start-in-gear prevention. The switch controls power to the engine starter circuit of the ignition switch. The engine gear shift control lever must be in the NEUTRAL position to allow the ignition switch to activate the engine starter. This safety device will prevent the boat's engine from starting if the engine is in gear. Most throttle/shift controls have this feature.

NAVIGATION LIGHTS SWITCH

The navigation lights switch is an ON/OFF push button on the left dash panel. The ANCHOR position is used when your boat is at rest after dark in open waterways. In this position only will the 360° tower light or pole light will be illuminated. When your boat is under way between sunset and sunrise, the switch must be placed in the NAVIGATION position. This will activate both the 360° tower and/or pole light, but also the bow red/green running lights.

NOTE — Boats not equipped with towers are not equipped with international lighting for use in coastal waters.

Never operate the boat between sunset and sunrise using only the stern light. Use all navigational lights when operating underway between sunset and sunrise. For additional information, see *Navigational Lights and Night Operation on page 7-13*.

BLOWER SWITCH

The blower switch activates the engine compartment blower. When in the ON position the blower will help to eliminate fumes from the engine compartment.

 **WARNING** *Gasoline vapors can explode. Before starting the engine, operate the blower for at least four minutes and check the engine compartment for gasoline leaks and vapors. Always run the blower below cruising speed.*

BILGE PUMP SWITCH

The bilge pump switch activates the bilge pump. When in the ON position the bilge pump is activated to pump out any excess water in the bilge area. The bilge pump also has a float switch that automatically turns on when the water level rises approximately 1.5 in. or more in the bilge area.

HORN SWITCH

The horn switch controls power ON/OFF to sound the horn. For additional information, see *Audible Signals on page 7-2*.

COURTESY AND DOCKING LIGHT SWITCH

These lights are controlled by the Touch Vision II system. See *Section 8 - Helm and Controls* for operation. Do not use courtesy or docking lights while operating your boat above idle speeds.

TOWER LIGHT SWITCH (OPTIONAL)

These lights are controlled by the Touch Vision II system. See *Section 8 - Helm and Controls* for operation.

TRIM TAB SWITCH (OPTIONAL)

The trim tab switch controls the up or down movement of the stinger wake plate.



BALLAST TANK SWITCH (OPTIONAL)

Ballast tank filling and draining is controlled by the Touch Vision II system. See *Section 8 - Helm and Controls* for operation.

COCKPIT HEATER SWITCH (OPTIONAL)

The heater switch turns on the optional cockpit area heater blower. For additional information on the cockpit heater system, See *Cockpit Heater System (Optional)* on page 9-19 and the *Heater System Operator's manual*.

SHIFT AND THROTTLE CONTROLS

Knowing how to operate the shift and throttle controls of your boat is essential for safe and proper operation.

The following basic and typical information may not apply to your specific shift control. See the *Engine Operator's Manual* or control manufacturer's instructions for information on your throttle and shift control operation, adjustment and maintenance.

Single-Lever Controls

Single-lever controls operate both the gear shift and the throttle for one engine with one control lever.

NEUTRAL - The lever is detented in the NEUTRAL position (center of travel) for starting; the neutral safety switch allows starting in this position only. For engine warm-up, a separate lever or button on the control allows the throttle to advance only while the transmission remains in NEUTRAL.

FORWARD - Release the detent lock to allow shifting to the FORWARD position. Moving the lever into the first 15° of travel (toward the bow or up) positions the control in the FORWARD detent IDLE position. Advancing the lever beyond 15° allows throttle increase in FORWARD.

REVERSE - Release the detent lock to allow shifting to the REVERSE position. Moving the lever into the first 15° of travel (toward the stern or down) positions the control in the REVERSE detent idle position. Advancing the lever beyond 15° allows throttle increase in REVERSE.

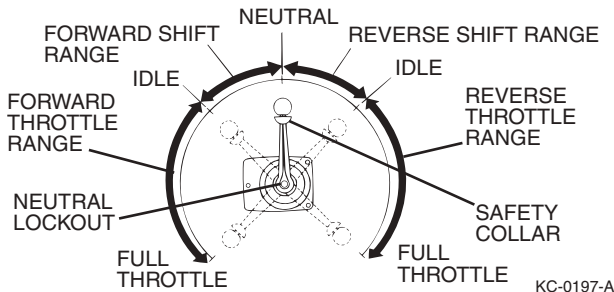

Typical Shift and Throttle Control



Control Operation Guidelines

⚠ WARNING *Control Hazard: Improperly maintained controls are hazardous and may cause sudden loss of control. Make sure all shift/throttle hardware and cables are regularly inspected and maintained. Improper maintenance may result in a loss of control.*

- Side mount throttle and shift controls have a neutral detent locking lever that must be released before shifting from NEUTRAL.
- Always use a brisk and decisive movement when shifting into or out of gear.
- Always pause in NEUTRAL before shifting from FORWARD to REVERSE, or REVERSE to FORWARD. Most throttle and shift controls have a detent position for NEUTRAL, FORWARD and REVERSE engagement positions. Engine damage may occur if you rapidly shift into gear without pausing in these detent positions or allowing the engine RPM to lower into the approved shifting range.
- When traveling at high speed, never shift into REVERSE while your boat is in FORWARD gear.
- Always keep the shift control clean and clear of obstructions.

NOTICE *Most shift and throttle controls are equipped with a safety switch for start-in-gear prevention. Place the control in the NEUTRAL position before you attempt to start the engine.*

- Never attempt to shift when the engine is not running.

CAPTIVE TOUCH SxS HD DASH SYSTEM (RI SERIES MODELS)

The Centurion Captive Touch SxS HD Dash System integrates instrumentation and control from electronically controlled engines communicating via SAE J1939 and NMEA 2000. The displays are multi-functional tools that provide GPS tracking, infotainment, cruise control and rider profiles, and enable operators to view many different settings for the engine, ballast, CATS, trim tab and display.

DRIVER'S POWER COMMAND CENTER

DASH CONTROLS

The master/main power key switch panel is located on the panel to the right of the steering wheel.

All power to the dash is controlled by the master/main power switch.

NOTE — Ensure the safety kill switch is attached correctly so that power can be supplied to the dash.



POWERING UP YOUR SYSTEM

Master/Main Power Switch: The main power key switch supplies power to the ignition button and switches. The key must be in the ON position to operate the dash and boat.

To Power Up: Push the Power button. After a few seconds the display, dash and gauges will respond, and you are ready to operate your Centurion controller.

To START your engine: Once you have powered up, push the Start button and release it. Your Pleasurecraft Marine Engine Company (PCM) engine features an auto-crank function that will crank until the engine starts.

To STOP your engine: Push the Stop button to turn your engine OFF. This feature keeps the dash electronics powered up.

ACCESSORIES

The LED indicators in the switches are active for nighttime operation with the navigation lights in the ON position. The navigation switch indicator will be on whenever the main power switch is in the ON position.

The navigation lights, bilge, blower and radio can be operated with the main power switch in the ON position and the ignition in the OFF position.

SHUTTING DOWN YOUR SYSTEM

To shut down the system, push the Power button to turn off the system, then turn the main power switch to the OFF position and remove the key so all power to the dash functions is off and secure.

FEATURES

CENTURION RI CONFIGURATION

RIGHT DISPLAY



Home Screen





NOTE — In the bottom navigation pane, the corresponding information will display, when an icon is tapped.

Section 8

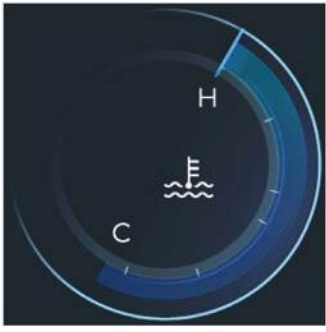

Tab Controls

ICON	DESCRIPTION
	Tap the up or down arrows to adjust the Center Tab controls.
	Tap the left or right arrows to adjust the CATS; ranging from -50 to +50
	Tap to access system settings.

Gauges

ICON	DESCRIPTION
 An analog gauge with a blue needle pointing to 2800 RPM. The gauge has a scale from 0 to 50 with major markings every 10 units. The text "2800 RPM" is displayed in the center.	Analog + digital RPM.
 An analog gauge with a blue needle pointing to the right. The gauge has a scale with markings. The letters "H" and "C" are positioned at the top and bottom of the scale respectively. A thermometer icon is in the center.	Analog engine temperature
 A white icon of a thermometer with a bulb at the bottom, partially submerged in wavy lines representing water.	Water temperature

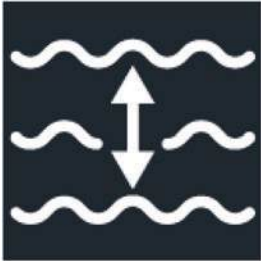
Section 8

ICON	DESCRIPTION
	Water depth
	Battery voltage
	Compass

Top Buttons

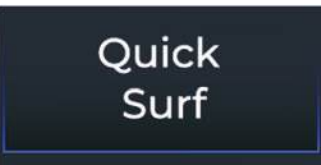
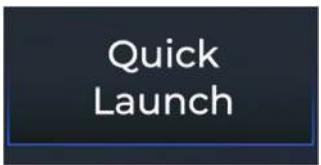
ICON	DESCRIPTION
 The icon for the SurfLeft feature, showing the text "SurfLeft" and a person icon on a blue background.	The Profile feature displays all default and created profiles with the ability to add, edit, and remove.
 The icon for the Quick Surf feature, showing the text "Quick Surf" on a dark blue background.	The Quick Surf feature automatically activates the Surf Right function, and applies an editable value for the P Tab Setpoint gauge (the port).
 The icon for the Quick Launch feature, showing the text "Quick Launch" on a dark blue background.	The Quick Launch feature disables the Quick Surf function and only engages C tab

Section 8





Ballast Screen

From the main right display, in the bottom navigation pane, tap the Ballast icon (6th symbol).







Ballast Controls

Buttons exclusively on the Ballast page are shown in the table below.

ICON	DESCRIPTION
	To fill the respective ballast.
	To fill all the ballasts.
	A real-time display of a ballast filling.
	To drain the respective ballast.

Section 8

ICON	DESCRIPTION
	To drain all the ballasts.
	A real-time display of a ballast draining.
	To halt the fill or drain of the respective ballast.
	To halt the fill or drain of all ballasts.

Trailer Mode



- From the Ballast page, tap Trailer Mode.
- The Trailer Mode pop-up dialog box displays open and close options to fill or drain the gates.

NOTE — Under the Open and Close buttons in the Fill Gates and Drain Gates areas, a message displays if both gates are opened or closed.

- When finished, tap the Close icon.

Ramfill Ballasts

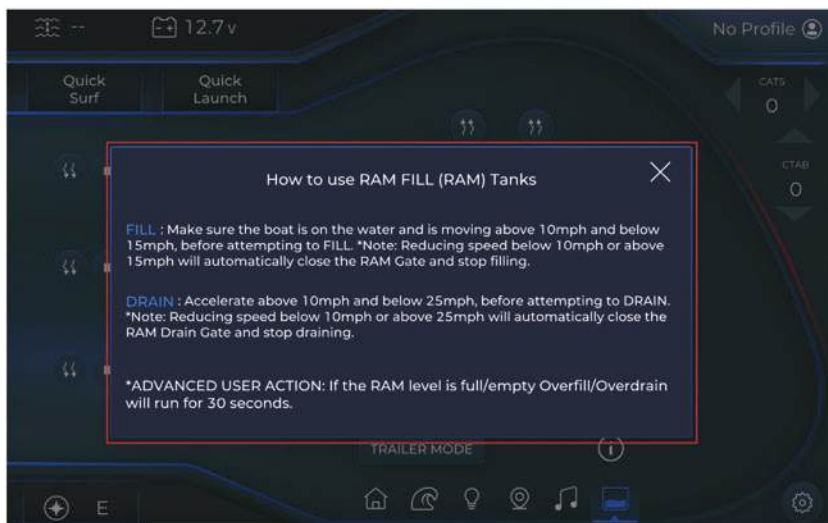

NOTE — Adjacent to each ballast are 3 respective features: Drain, Stop, and Fill.

- To select a specific ballast, locate the appropriate ballast.

NOTE — When either the drain or fill option is selected, a connector line will display.

- To drain the ballast, tap the Drain icon.

NOTE — To halt the drain, tap the Stop icon.

- To fill the ballast, tap the Fill icon.

NOTE — To halt the fill, tap the Stop icon.

- To simultaneously drain all the ballasts, locate the All area.
- Tap Fill.

NOTE — The Ramfill Fill Disabled pop-up dialog box will appear if the boat speed is not between 8-15 MPH.

- To simultaneously drain all the ballasts, tap Drain All.

NOTE — The Ramfill Drain Disabled pop-up dialog box will appear if the boat speed is not between 8-23 MPH.

- To halt, all ballasts from filling or draining, tap Stop.

Switching Screen

From the main right display, in the bottom navigation pane, tap the Lighting icon (3rd symbol).



Section 8

RGBW Outputs



- Locate the appropriate RGBW output(s):
 - All RGBW (applying the same color for all outputs)
 - Tower Speakers
 - Interior Speakers
 - Interior
 - Underwater
- To activate/deactivate toggle on/off the RGBW output.
- Tap the corresponding vertical color bar.
- The respective RGBW Output Preset pop-up window will display.
- Locate the Presets area.
- Tap the appropriate color.
- To customize a preset color, tap Advanced.
- The Advanced pop-up window displays.



- To apply a custom color, simultaneously touch and slide the circle on the color wheel to the appropriate color.
- To adjust the brightness, simultaneously touch and slide the brightness slider to the appropriate setting.
- The color is reflected in the adjacent square.
- To save the customized color as a preset, locate the Presets area.
- Touch and hold the appropriate preset option.
- The selected preset is now updated.
- When finished, tap the Close icon.

Switching Outputs

- Locate the appropriate switching output(s):
 - Docking
 - Heater Fan
 - Seat Heater
 - Exterior
- To activate/deactivate toggle on/off the appropriate options.

Audio Screen

From the main right display, in the bottom navigation pane, tap the Audio icon (5th symbol).

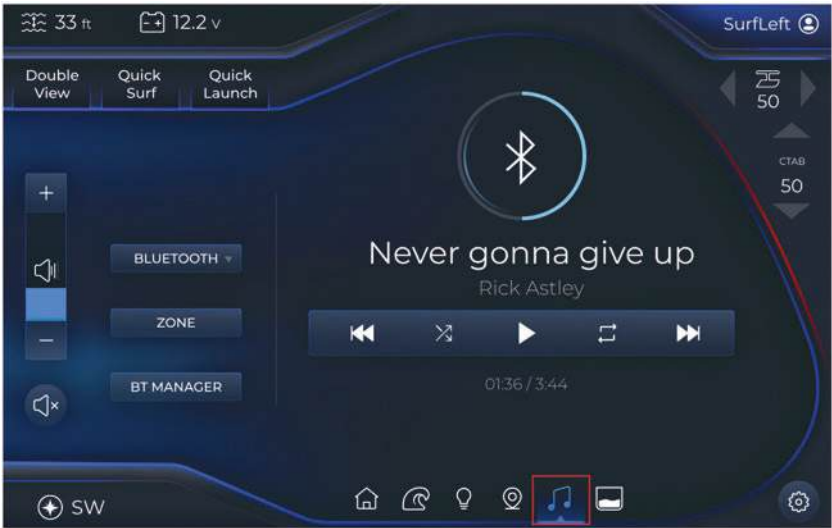

Auto Volume

NOTE — The Auto Volume feature will adjust the decibel based on the vehicle's RPM.

- To activate the decibel automatically adapting, tap Auto Volume.
- The Auto Volume button is now highlighted.
- To set the volume at a constant decibel, re-tap Auto Volume.
- The Auto Volume button is now unhighlighted.

Source Selection

NOTE — The active option displays on the Source Selection drop-down button.

- Additionally, the respective controls are right-adjacent.
- Tap the Source Selection drop-down.
- 5 options are displayed:
 - FM Radio, AM Radio
 - ◆ Controls:
 - Seek
 - Tune
 - Favorite
 - WX Radio
 - ◆ Controls:
 - Seek
 - Tune
 - AUX
 - ◆ Control:
 - AUX Connected
 - Bluetooth
 - ◆ Controls:
 - Shuffle
 - Loop
 - Pause
 - Forward
 - Back
 - Song name
 - Song timeline
- Tap the appropriate option.
- The selected option and its corresponding controls are now displayed.

Section 8

Favorites

NOTE — The Favorite feature is only available for the FM and AM radio options.

NOTE — A maximum of 5 favorites are provided.

- Tap the Source Selection drop-down.
- Locate and tap the appropriate option.
- In the right-adjacent area, locate the corresponding options.
- Navigate to the desired radio station.

NOTE — If less than 5 favorites are displayed, tap the Favorite icon.

- The selected favorite is now displayed.

NOTE — If 5 favorites are populated, locate the appropriate favorite to override.

- Touch and hold on the appropriate favorite.
- The favorite is now updated to the current radio station.

Zone

- The Zone feature provides the ability to manually change the volume of a specific area:
 - Downfire
 - Tower
 - Sub
 - Interior
- Tap Zone.
- 4 tabs are displayed: Downfire, Tower, Sub, Interior.
- Tap the appropriate tab.
- The corresponding volume controls are displayed.
- Tap the negative icon to decrease the volume.
- Tap the positive icon to increase the volume.
- (Un)tap the Speaker icon to (un)mute the sound.
- When finished, tap Done.

Bluetooth Manager

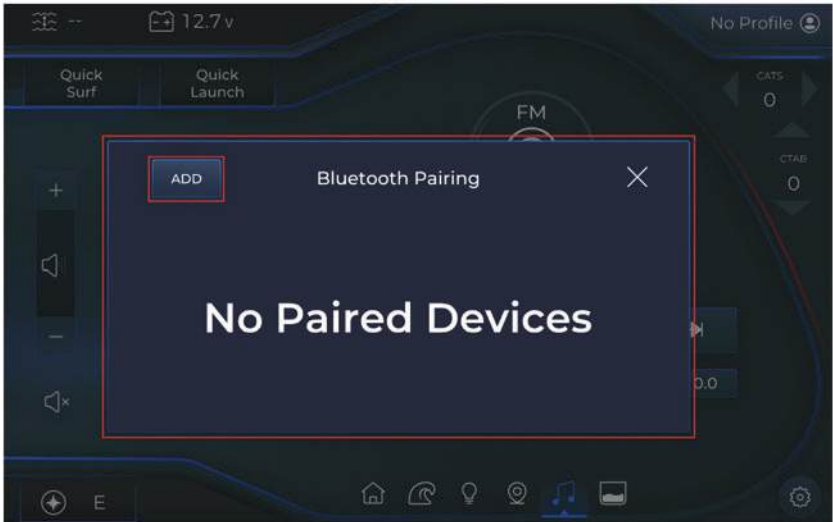

- Tap BT Manager.
- In the Bluetooth Pairing pop-up window, tap Add.
- Activate the appropriate bluetooth device.
- Locate and tap the appropriate pairing device.
- Tap OK.
- The connected bluetooth device is now displayed.
- To exit the Bluetooth Pairing pop-up window, tap the Close icon.

Section 8

Surf Screen



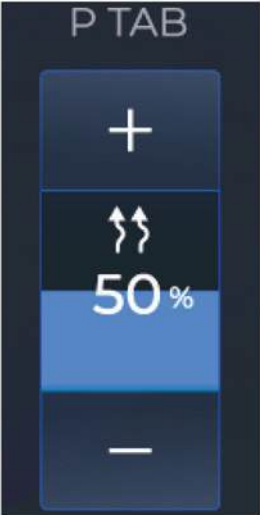
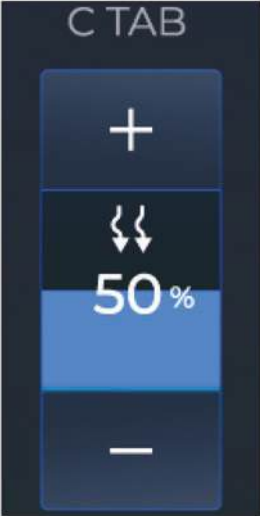

Buttons on the Surf Screen page are shown in the table below.

Tab Controls

ICON	DESCRIPTION
 The image shows a vertical control panel for the 'P TAB' (Port). At the top, the text 'P TAB' is displayed. Below it is a dark blue button with a white plus sign '+'. Underneath is a button with two white up-pointing arrows. A blue horizontal bar is positioned below the arrows, with the text '50%' centered on it. At the bottom is a dark blue button with a white minus sign '-'.	<p>The P Tab Setpoint (Port) allows for setting the value (up and down arrows) of the left side of the vessel when facing the bow, or front, of the boat.</p> <p>NOTE – This feature is only available if the Surf Right or Quicksurf button is tapped.</p>
 The image shows a vertical control panel for the 'C TAB' (Center). At the top, the text 'C TAB' is displayed. Below it is a dark blue button with a white plus sign '+'. Underneath is a button with two white down-pointing arrows. A blue horizontal bar is positioned below the arrows, with the text '50%' centered on it. At the bottom is a dark blue button with a white minus sign '-'.	<p>The C Tab Setpoint (Center) allows for setting the value (up and down arrows) of the center of the vessel. When speed reaches 20 MPH, C tab goes to 50%, when speed reaches 25+ mph C tab goes to 20%.</p>

ICON	DESCRIPTION
 <p>The image shows a digital control interface for the S TAB. At the top, the text "S TAB" is displayed. Below it is a vertical slider control. The slider has a plus sign (+) at the top and a minus sign (-) at the bottom. In the center of the slider, there are two downward-pointing arrows and the text "50%", indicating the current setpoint.</p>	<p>The S Tab Setpoint (starboard) allows for setting the value (up and down arrows) of the right side when facing the bow, or front, of the ship.</p> <p>NOTE – This feature is only available if the Surf Left button is tapped.</p>
 <p>The image shows a rectangular button with a dark background and a light blue border. The text "Quick Surf" is centered on the button in a white, sans-serif font.</p>	<p>The Quick Surf feature automatically activates the Surf Right function, and applies an editable value for the P Tab Setpoint gauge (the port).</p>
 <p>The image shows a rectangular button with a dark background and a light blue border. The text "Quick Launch" is centered on the button in a white, sans-serif font.</p>	<p>The Quick Launch feature disables the Quick Surf function and only engages C tab.</p>

Section 8

ICON	DESCRIPTION
	Surf Right shifts the boat on the right and enables the P Tab Setpoint (Port) C Tab Setpoint (Center) options.
	Surf Left shifts the boat on the left and enables the C Tab Setpoint (Center) and S Tab Setpoint (starboard) options.
	The Save As button saves all applied settings into a profile. This profile becomes a template that can be reused.
	The Save button saves the applied settings into a pre-existing profile, which can be selected in the Save Settings pop-up dialog box.

From the main right display, in the bottom navigation pane, tap the Surf icon (2nd symbol).



Save/Save As

- Set the appropriate options.
- To save the applied tab settings, tap Save.

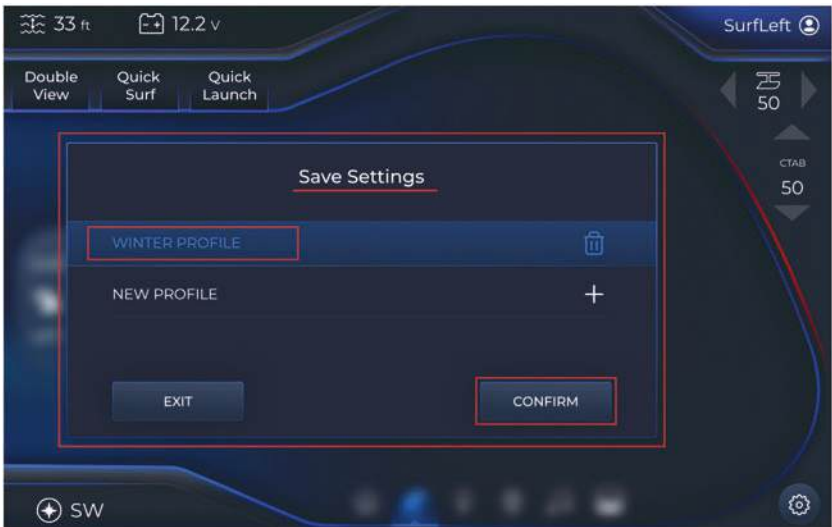

- In the Save Settings pop-up dialog box, locate and tap the appropriate profile.
- To apply, tap Confirm.

Section 8

- Alternatively, to save the applied tab settings to a new profile, tap Save As.



- In the pop-up dialog box, enter the appropriate profile name.
- Tap the Enter (the checkmark) icon.



- The profile is now automatically displayed (and activated) in the top-right corner of the main right display.
- To view the profile, tap the profile.



- The Profile pop-up window is displayed and lists all the applied settings.



NOTE — To gain a step-by-step understanding of how to edit the settings, please refer to the Profile Pop-up section.



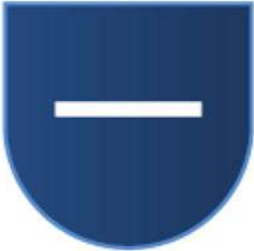

- When finished, tap the Close icon.

Section 8





Maps Screen Map Controls

Buttons exclusively on the Map page and pop-up window are shown in the table below:

ICON	DESCRIPTION
	To zoom in the map.
	To zoom out the map.
	This icon indicates Pan mode. Tap to cycle between centering the map with a north up direction, centering the map with a forward up direction, or Pan mode.

ICON	DESCRIPTION
	This icon indicates centered Map mode. Tap to cycle between centering the map with a north up direction, centering the map with a forward up direction, or Pan mode.
	To add a waypoint.
	To add a track.
	To display a list of the waypoints and tracks

Section 8

ICON	DESCRIPTION
	To orient to the assigned waypoint.
	To edit the waypoint/track name.
	To delete the selected waypoint/track.
	To toggle waypoint/track visibility on/off.
	The Waypoints tab in the pop-up window.

ICON	DESCRIPTION
 A dark blue rectangular button with the word "Tracks" in white text and a small white triangle pointing upwards at the bottom center.	The Tracks tab in the pop-up window.

From the main right display, in the bottom navigation pane, tap the Map icon (4th symbol).



Waypoints

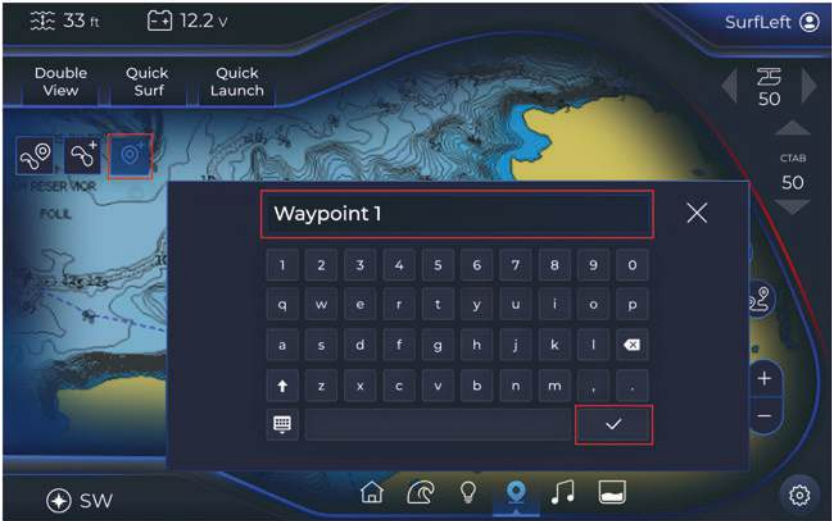

Add a Waypoint

- From the Map page, locate the left-hand area.
- Tap the Waypoint icon.
- In the pop-up dialog box, enter the appropriate information.
- When finished, tap the Enter (checkmark) icon.
- The waypoint is now displayed on the Map page.



Tracks

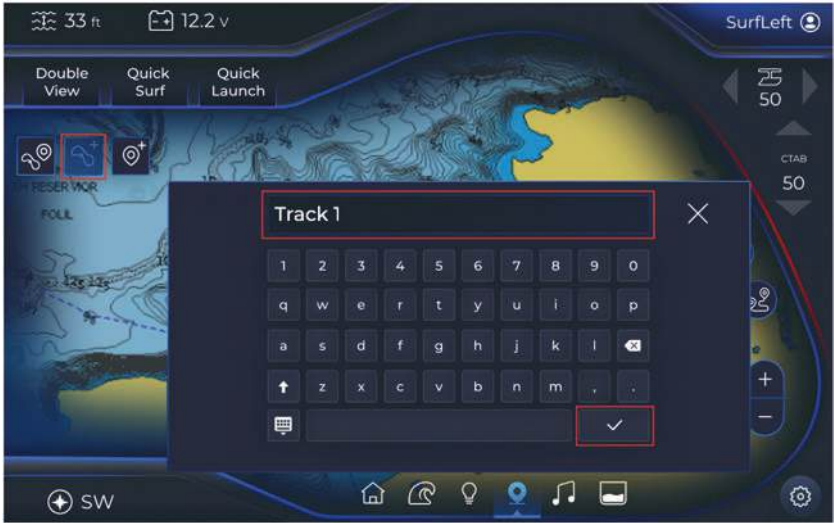

Add a Track

- From the Map page, locate the left-hand area.
- Tap the Track icon.
- In the pop-up dialog box, enter the appropriate information.
- When finished, tap the Enter (checkmark) icon.
- The track is now added.

Section 8



Popup

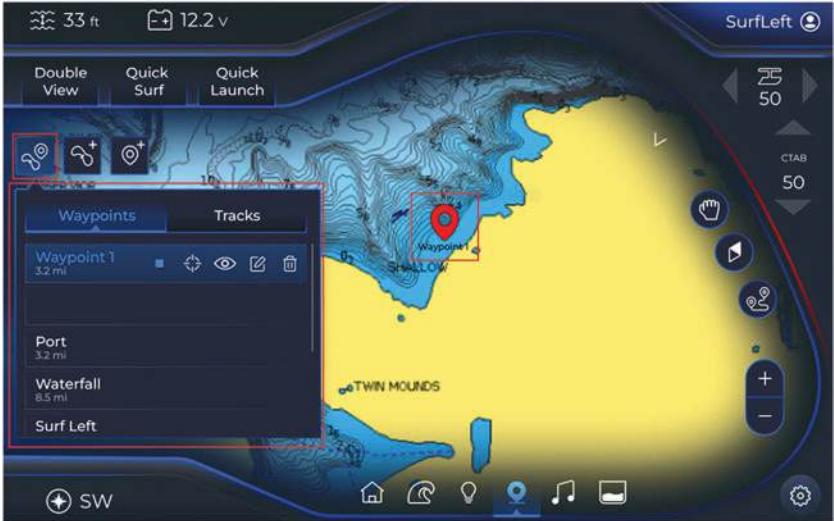

Waypoints

- From the Map page, locate the left-hand area.
- Tap the Waypoint and Track List icon.
- The pop-up window is displayed on the Map page.

NOTE — In the pop-up window, there are 2 tabs: Waypoints & Tracks.

- Tap the Waypoints tab.
- The listed waypoints are displayed.
- Each waypoint has 4 corresponding options:
 - Orient to the waypoint (1st icon).
 - Navigate to the waypoint (2nd icon).
 - Rename the waypoint (3rd icon).
 - Delete the waypoint (4th icon).
- Set the appropriate options for the selected waypoint.
- When finished, tap the Close icon.

Section 8

Tracks

- From the Map page, locate the left-hand area.
- Tap the Waypoint and Track List icon.
- The pop-up window is displayed on the Map page.

NOTE — In the pop-up window, there are 2 tabs: Waypoints & Tracks.

- Tap the Tracks tab.
- The listed tracks are displayed.
- Each track has 3 corresponding options:
 - Toggle the visibility on/off (1st icon).
 - Rename the track (2nd icon).
 - Delete the track (3rd icon).
- Apply the appropriate settings for the selected track.
- When finished, tap the Close icon.

Profile Popup

From the main right display, in the top right-hand corner, tap the Profile icon.



Create New

NOTE — In the Profile pop-up window, there are 3 default profiles:

- Wakeboard
- Pro Surf Left
- Pro Surf Right

To create a new profile, tap Add.



- The Profile list displays 12 field options:
 - Name
 - Quick Surf
 - Surf Tab
 - Center Tab
 - Set Speed
 - Center
 - STBD RAM
 - PORT RAM
 - BOW PNP
 - TRANSOM PNP
 - STBD PNP
 - PORT PNP

NOTE — The fields are automatically populated with default values.

- Tap Name.

Section 8

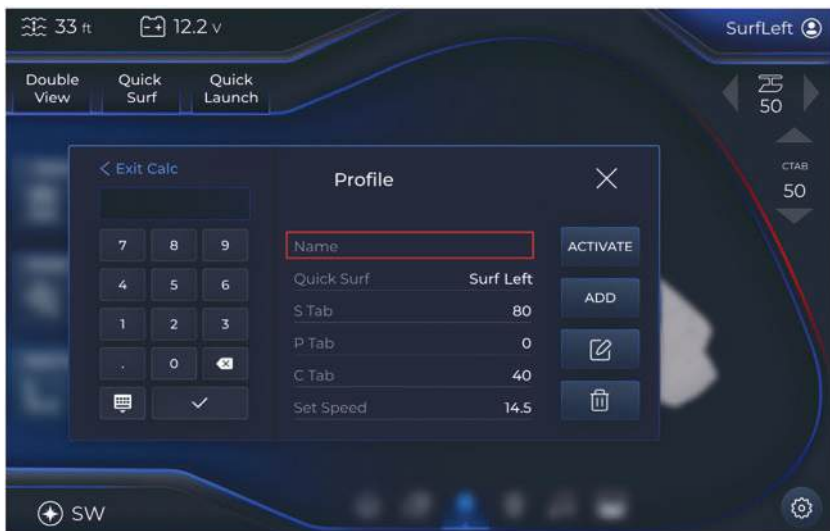

- In the pop-up dialog box, enter the appropriate information.
- Tap the Enter (checkmark) icon.

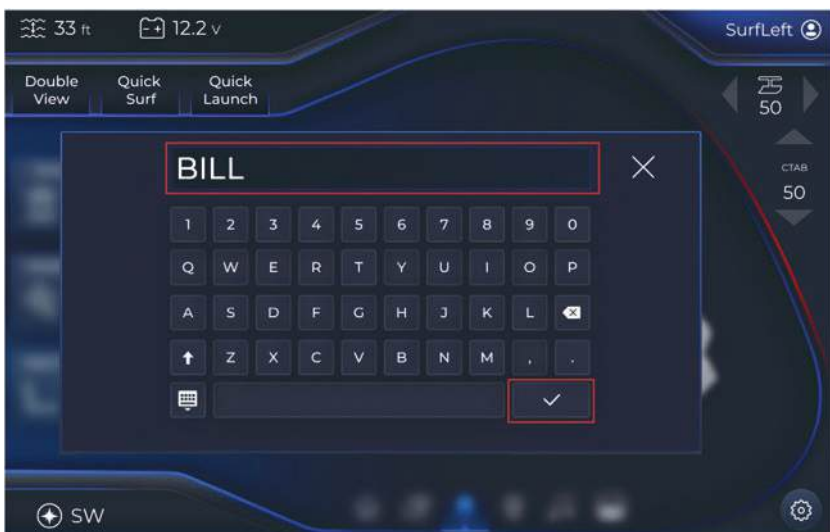

- The entered name is now displayed.

- Locate Quick Surf.
- Tap the respective setting until the desired option is displayed.

NOTE — The available options will cycle.



- Locate Surf Tab.
- Tap the corresponding value and locate the left-adjacent window.
- Enter the appropriate value and tap the Enter (checkmark) icon.

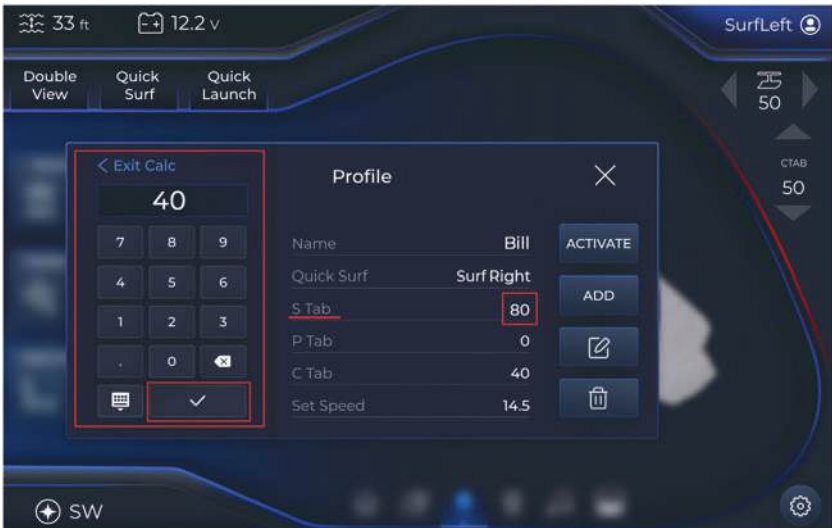

Section 8

NOTE — The field is now updated with the corresponding data.



- To alter other settings in the Profile list, repeat the process.

Edit Profile

NOTE — The default profiles are uneditable.

- Locate and tap the appropriate profile.
- Tap Edit.

NOTE — To change the quick surf value, continuously tap the corresponding option to cycle through the features. All other field options require an entered value.

NOTE — To edit a name, a pop-up dialog box will display.

- In the Profile list, tap the appropriate option.
- Locate the left-adjacent window and enter the appropriate value.
- Enter the appropriate value and tap the Enter (checkmark) icon.
- The new value is now displayed in the corresponding field.
- To alter other settings in the Profile list, repeat the process.
- When finished, locate the right-hand side of the Profile pop-up window.
- Tap the Enter (checkmark) icon.
- The edits are now saved for the selected profile.

Go Home Mode

NOTE — When the Go Home feature is selected, all ballasts will drain and cruise control will automatically set to 22 MPH.

- Tap Go Home.
- The option is now activated.

Activate/Deactivate Profile

- Locate and tap the appropriate profile.
- The Profile list displays the profile's information.
- Tap Activate.
- The profile is now activated.
- To deactivate the profile, tap Deactivate.

Menu

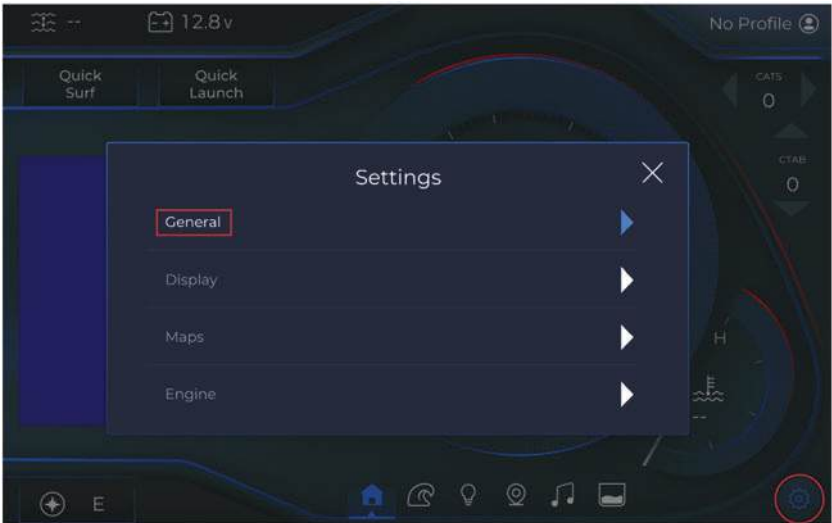

Factory Reset

- From the main right display, in the bottom right-hand corner, tap the Settings icon.
- In the Settings pop-up window, tap General.
- Simultaneously touch and scroll up to locate the Factory Reset option.
- Tap Factory Reset.



- In the Factory Reset pop-up dialog box, tap Confirm.

NOTE — A proceeding Factory Reset pop-up dialog box will appear with the message

- “Factory reset in progress – display will reboot”.
 - To immediately close, tap OK; If no action is performed the window will eventually disappear.



Reboot to Loader

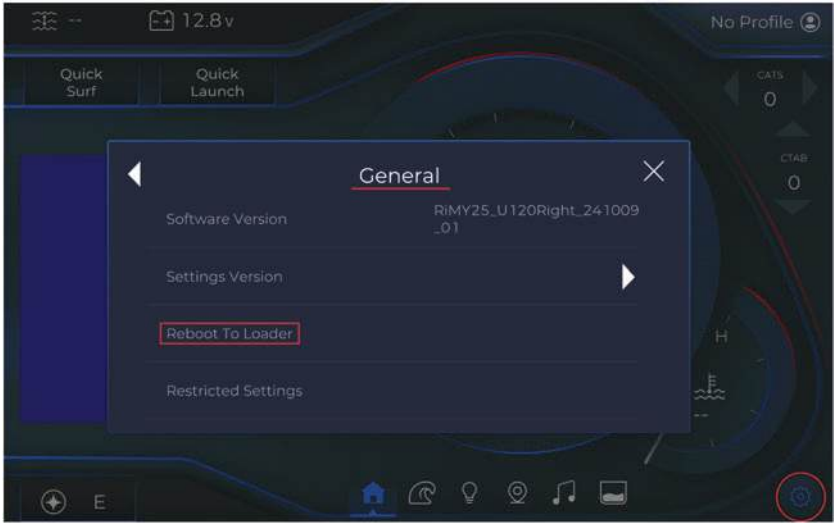

NOTE — This is a rescue-mode restart feature; switches the display into reboot mode; permits loading information onto the USB drive and to re-install software.

- From the main right display, in the bottom right-hand corner, tap the Settings icon.
- In the Settings pop-up window, tap General.
- Tap Reboot to Loader.

Dealer Settings

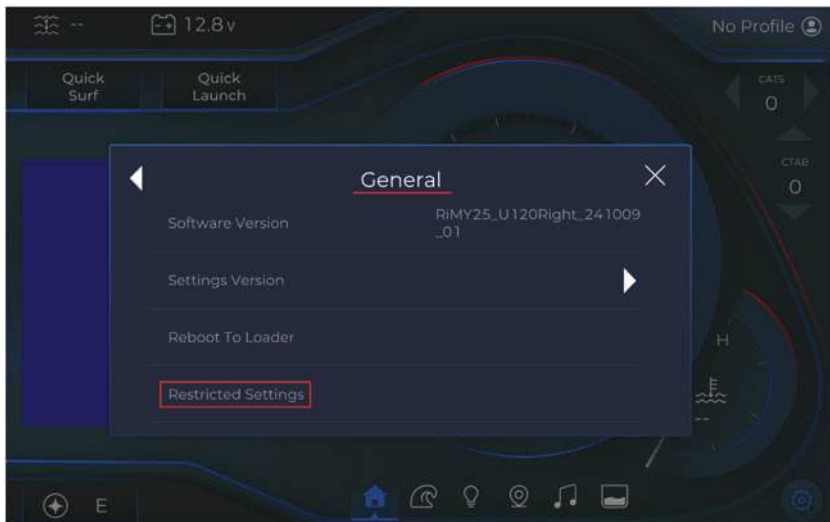

- From the main right display, in the bottom right-hand corner, tap the Settings icon.
- In the Settings pop-up window, tap General.
- Simultaneously touch and scroll up to locate the Restricted Settings option.

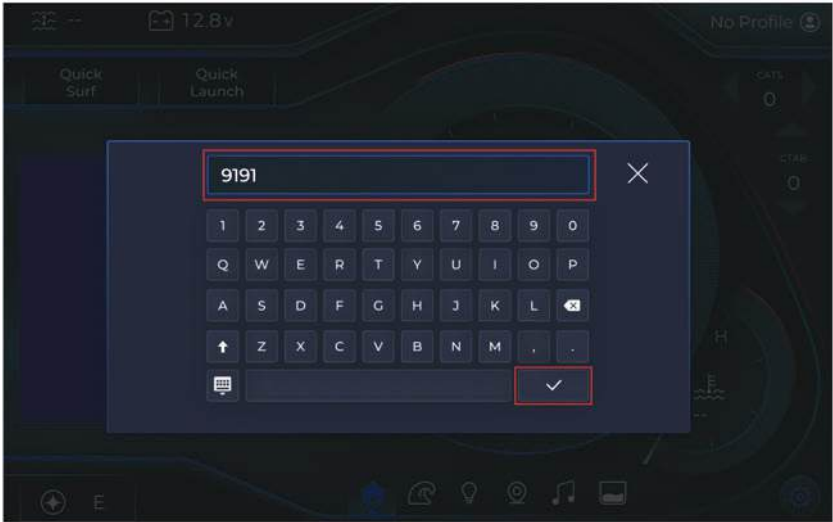

- In the pop-up dialog box, enter the appropriate passcode.
- Tap the Enter (checkmark) icon.

NOTE — Once the passcode is submitted, the Settings pop-up window automatically re-displays.

- The Dealer options are now accessible
- In the Settings pop-up window, tap General.
- Simultaneously touch and scroll up to locate the Dealer Options feature.
- Tap Dealer Options.
- 4 Dealer Options are displayed:
 - Installation Options
 - ◆ Tap Installation Options.
 - ◆ Toggle on/off the appropriate features:
 - RGBW
 - Heater
 - Seat Heater
 - Underwater Lights
 - Interior Lights
 - Exterior Lights
 - CATS
 - Bow Ballast
 - Transform Ballast
 - Starboard Ballast
 - Port Ballast
 - Port Ramfill

- ◆ To revert to the Dealer Options page, in the left-hand corner, tap the Back (left arrow) icon.
- Boat Model
 - ◆ Tap Boat Model.
 - ◆ 3 options are displayed:
 - Ri230
 - Ri240
 - Ri265
 - ◆ Tap the appropriate option.
 - ◆ To revert to the Dealer Options page, in the left-hand corner, tap the Back (left arrow) icon.
- Boat Scheme
 - ◆ Tap Boat Scheme.
 - ◆ 4 options are displayed:
 - Core
 - Warrior
 - Drive
 - Slice
 - ◆ Tap the appropriate option.
 - ◆ To revert to the Dealer Options page, in the left-hand corner, tap the Back (left arrow) icon.
- Customization
 - ◆ Tap Customization.

NOTE — This feature is for boat colorization.

- ◆ 7 options are displayed:
 - Hull Base
 - Hull Main Front
 - Hull Accent
 - Upholstery
 - Deck
 - Tower
 - Trim
- ◆ Tap the appropriate option.
- ◆ Tap the appropriate color.
- ◆ To revert to the Dealer Options page, in the left-hand corner, tap the Back (left arrow) icon.

Wake Feature: Ballast Fill and Drain Times

NOTE — The Wake feature is only active if the Dealer Settings are enabled.

- Refer to the Dealer Settings section, to activate the dealer features.
- From the main right display, in the bottom right-hand corner, tap the Settings icon.

- Simultaneously touch and scroll up to locate the Wake option.
- Tap Wake.
- All (5) ballasts are displayed:
 - Port Ballast
 - Starboard Ballast
 - Center Ballast
 - Bow Ballast
 - Transom Ballast
- Locate and tap the appropriate ballast.
- In the respective ballast window, there are 3 options:
 - Enabled/Disabled toggle button
 - ◆ Tap the toggle button to the appropriate option.
 - Ballast Empty time
 - ◆ Tap the corresponding time.
 - ◆ Adjacent decrease and increase buttons are now displayed.

NOTE — The buttons apply 10-second increments.

- ◆ Set the appropriate time.
- Ballast Fill Time
 - ◆ Tap the corresponding time.
 - ◆ Adjacent decrease and increase buttons are now displayed.
 - ◆ Note: The buttons apply 10-second increments.
 - ◆ Set the appropriate time.
- To revert to the Wake page, in the left-hand corner, tap the Back (left arrow) icon.
- Locate and tap the appropriate ballast.
- Repeat the previous steps.
- When finished, tap the Close icon.

Wet Sounds Updater

NOTE — The Wet Sounds Updater is only active if the Dealer Settings are enabled.

- Refer to the Dealer Settings section, to activate the dealer features.

NOTE — Ensure the appropriate USB with updates is plugged into BB-10.

- From the main right display, in the bottom right-hand corner, tap the Settings icon.
- In the Settings pop-up window, tap Audio.
- Tap Update Wet Sounds Software.
- Tap Search for Update Files.

NOTE — On the right-hand side 3 horizontal dots will sequentially re-display until the files load.

- The updated files are now displayed.

Section 8

Theme Color

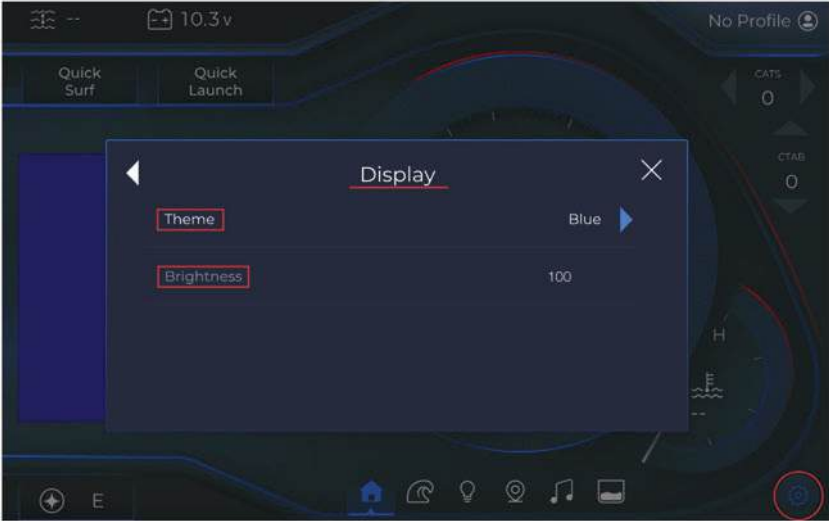

- From the main right display, in the bottom right-hand corner, tap the Settings icon.
- In the Settings pop-up window, tap Display.
- 2 Display options are shown:
 - Theme

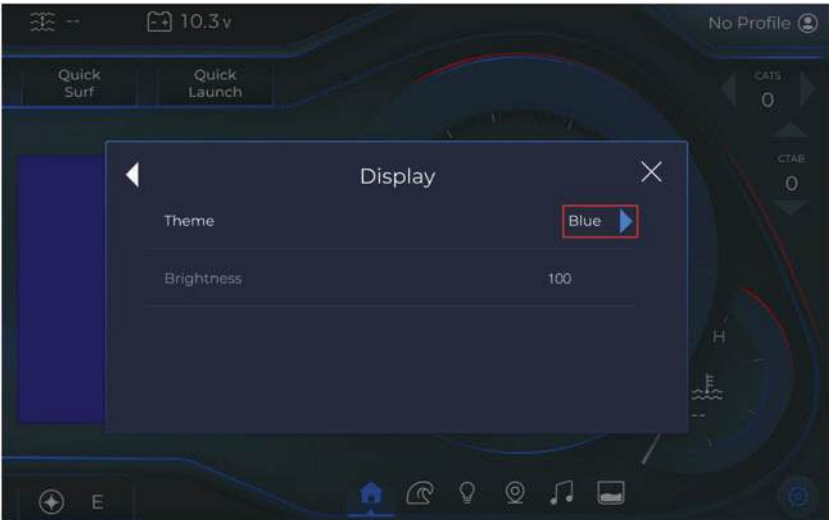

- ◆ Tap the respective color.
- ◆ Locate and tap the appropriate color.

NOTE — Default and custom colors options are provided.

- ◆ Tap the appropriate default color.
- ◆ Alternatively, to select a custom color, locate and tap the appropriate custom color.

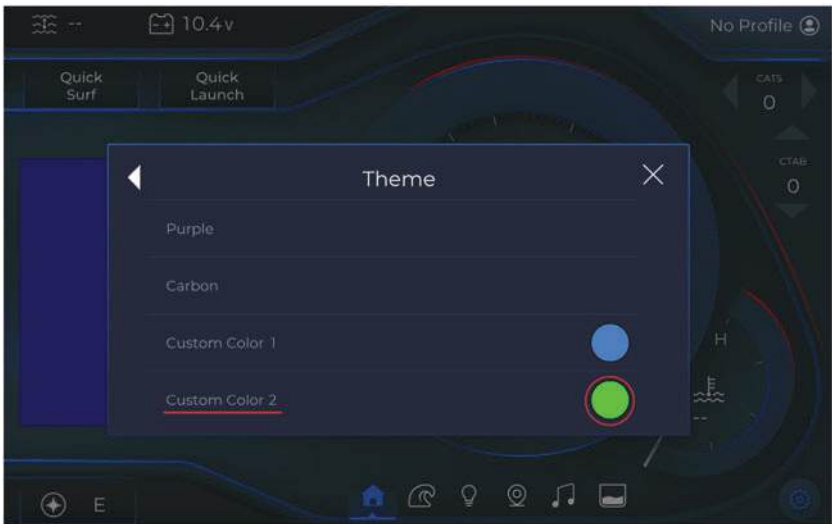

- ◆ The Theme Selection pop-up window is displayed.

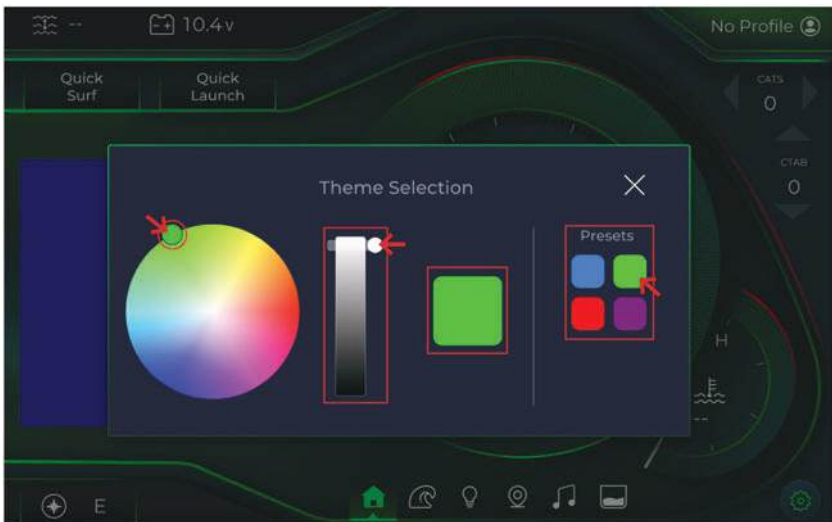

Section 8

- ◆ To quickly apply a color, locate the 4 preset color options.
- ◆ Tap the appropriate color.
- ◆ The color is now applied.
- ◆ Alternatively, to apply a custom color, simultaneously touch and slide the circle on the color wheel to the appropriate color.
- ◆ To adjust the brightness, simultaneously touch and slide the brightness slider to the appropriate setting.
- ◆ The color is reflected in the adjacent square.
- ◆ To save the customized color as a preset, locate the Presets area.
- ◆ Touch and hold on the appropriate preset.
- ◆ The selected preset is now updated.
- ◆ When finished, tap the Close icon.

– Brightness

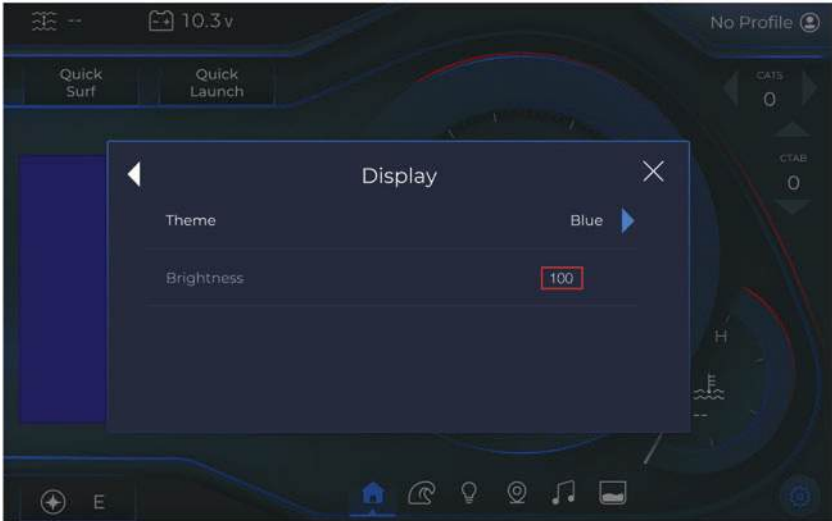

- ◆ Tap the respective number.
- ◆ Set the appropriate value.





LEFT DISPLAY

Home Screen



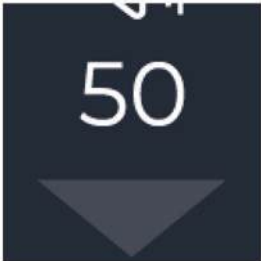

Tab Controls

ICON	DESCRIPTION
	Tap to increase the volume

ICON	DESCRIPTION
	Tap to decrease the volume
	Toggle to (un)mute the volume.
	Tap to Seek forward.
	Tap to Seek backward.



Section 8

ICON	DESCRIPTION
	Toggle to (de)active cruise control.
	Tap to increase the cruise control speed.
	Tap to decrease the cruise control speed.

Gauges

ICON	DESCRIPTION
 <p>The image shows a speedometer gauge with an analog needle pointing to 0 on a scale from 0 to 120. A digital display in the center shows '0.0' with 'KPH' and 'CRUISE OFF' below it. A 'ZERO OFF' indicator is visible at the bottom of the gauge.</p>	<p>Analog + digital speed (MPH).</p>
 <p>The image is a close-up of the digital speedometer display, showing '0.0' in large digits, with 'KPH' and 'CRUISE OFF' below it.</p>	<p>Cruise control status OFF.</p>

Section 8

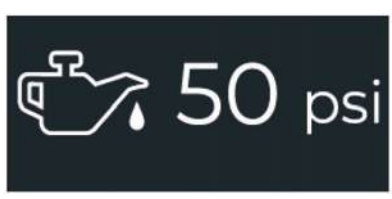
ICON	DESCRIPTION
	Cruise control status ON.
	Engine hours
	Fuel
	Oil pressure

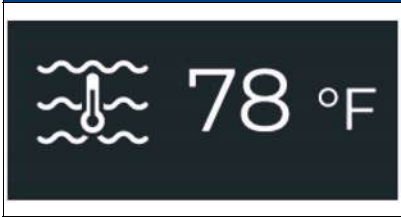
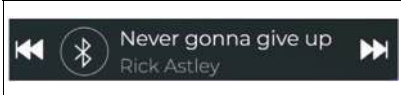
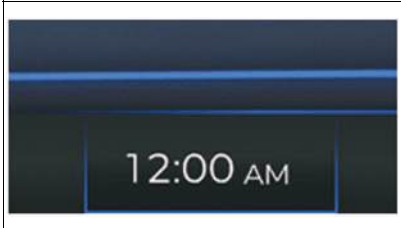
ICON	DESCRIPTION
	<p>Water temperature</p>
	<p>The selected audio device and digital output.</p>
	<p>The time display.</p>

Top Buttons

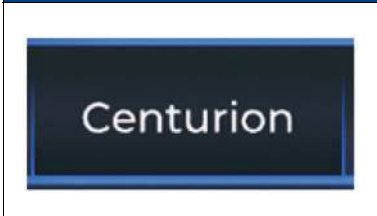
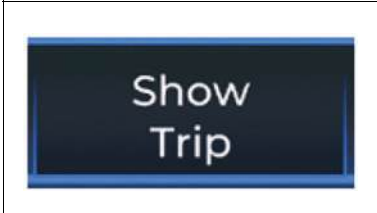
ICON	DESCRIPTION
	<p>A non-functional button for the camera display.</p>
	<p>The Show Trip option displays the trip information.</p>

Section 8

Cruise



- To (de)activate the cruise control feature (un)tap the Cruise Control icon.

NOTE — The Cruise Off/On text will reflect according to the applied setting.

NOTE — Activating Cruise Control will populate the Cruise Control speed options.

- In the right-adjacent area, locate the corresponding Cruise Control speed options.
- Tap the Up arrow to increase the speed.
- Tap the Down arrow to decrease the speed.
- The applied speed setting is reflected in the digital value.

Show Trip Information



- From the Cruise Control display, tap the Show Trip tab.

NOTE — Once this feature is active, it will replace the Camera display.

- The trip information is displayed:
 - Trip Time
 - Fuel Average
 - Fuel Used
 - Trip Distance
 - Fuel Rate
- To reset the trip information, tap Reset.
- To close the Trip Information window, retap the Show Trip tab.
- The Camera display is reactivated.

Section 8

Audio Controls



- On the bottom of the screen, the selected source is displayed along with its corresponding features.
- Muting and decreasing/increasing the volume is displayed on the left side of the display.

CENTURION FE CONFIGURATION

DISPLAY





Home Screen



NOTE — On the main display, when an icon is tapped, the corresponding information will display.



Section 8

Tab Controls

ICON	DESCRIPTION
	Tap the up or down arrows to adjust the CATS; ranging from -50 to +50.
	Docking Lights PDM Output
	Tower Lights PDM Output
	Interior RGBW Output





ICON	DESCRIPTION
	<p>In the RPM gauge area, under MPH, tap OFF to toggle ON cruise control (the button will turn a gradient blue when active) and re-tap to deactivate cruise control. Tap the negative or plus icons to adjust the MPH speedometer.</p>
	<p>To (de)active the camera.</p>

Section 8

Gauges

The gauges are shown in the table below. Note: Besides the RPM analog, all of the listed gauges are displayed on all pages: Home, Surf, Ballast, Maps, Lighting, Profile, Settings.

ICON	DESCRIPTION
	RPM
	Water depth
	Water temperature
	Fuel gauge

ICON	DESCRIPTION
 A grey battery icon with a white plus sign on the left and a minus sign on the right.	Battery voltage
 A grey thermometer icon with a bulb at the bottom and a scale on the right, floating in water represented by wavy lines.	Engine temperature
 A grey oil can icon with a handle on the left and a spout on the right.	Oil pressure
 A green circular icon with a white boat silhouette and a white anchor below it, surrounded by green radiating lines.	<p>Nav Anchor state</p> <p>Legend:</p> <ul style="list-style-type: none">• White = neither NAV or ANC ON.• Green = ANC ON.• Blue = NAV and ANC ON.

Section 8

Ballasts Screen

From the main display, in the top navigation pane, tap the Ballast icon (3rd symbol).



Ballast Controls

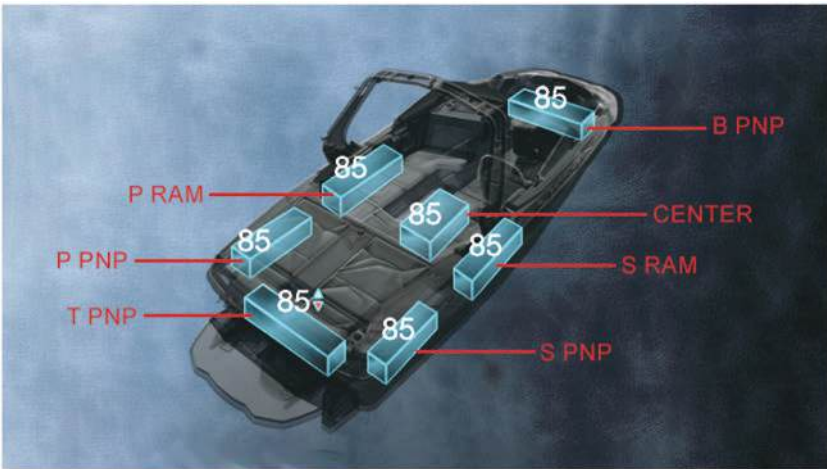

Trailer Mode

- From the Ballast page, tap Trailer Mode.
- The Trailer Mode pop-up dialog box displays open and close options to the fill or drain gates.

NOTE — The trailer mode should only be used when the boat is out of the water. Make sure to close the gates before launching.

- Locate the Fill Gates area and tap Open or Close.
- Locate the Drain Gates area and tap Open or Close.

NOTE — Under the Open and Close buttons in the Fill Gates and Drain Gates areas, a message displays if both gates are opened or closed.

- Gates will automatically close when the engine is turned on.
- When finished, tap Done.

Ramfill Ballasts



- To select a specific ballast, tap the appropriate ballast.

NOTE — The selected ballast will reflect in the ballast gauge.

NOTE — A respective green up arrow will display next to a filling ballast.

NOTE — A respective red down arrow will display next to a draining ballast.

- To fill the selected ballast, tap Fill.

NOTE — To halt the fill, tap Stop.

- To drain the selected ballast, tap Drain.

NOTE — To halt the drain, tap Stop.

- To simultaneously fill the ballasts, tap Fill All.

NOTE — The Ramfill Fill Disabled pop-up dialog box will appear if the boat speed is not between 8-15 MPH.

- To simultaneously drain all the ballasts, tap Drain All.

NOTE — The Ramfill Drain Disabled pop-up dialog box will appear if the boat speed is not between 8-23 MPH.

- When filling or draining options are selected, a Stop All button will appear. To halt, all ballasts from filling or draining, tap Stop All.

Section 8

Switching Screen

NOTE — To enable all RGBW options please adhere to the following steps:

- Activate the Restricted Settings.
- Navigate to the Dealer Options > Switching section > Toggle ON each setting to activate all options.
- Locate Dealer Options > RGBW > Tap RideController LED+

From the main display, in the top navigation pane, tap the Lighting icon (5th symbol).



RGBW Outputs

- Locate the appropriate RGBW output(s):
 - RGBW
 - ◆ To apply the same color for all outputs.
 - ◆ Color editing capabilities for specific outputs.
 - Tower SPK
 - Interior SPK
 - Interior
 - Underwater
- To activate an RGBW output, tap the appropriate output(s).
- To edit the color option for the selected output(s), tap RGBW.



NOTE — The RGBW output button name changes to RGBW ALL.

NOTE — The RGBW ALL feature simultaneously applies the chosen color to all RGBW outputs.



- The RGBW pop-up dialog box displays.
- In the RGBW All Zones area, set the appropriate color with either one of the presets or the color wheel and brightness slider:
 - To quickly apply a color, locate the 4 preset color options.
 - Tap the appropriate color.
 - Alternatively, to apply a custom color, simultaneously touch and slide the circle on the color wheel to the appropriate color.
 - To adjust the brightness, simultaneously touch and slide the brightness slider to the appropriate setting.
 - To set the custom color as a preset, touch and hold on a pre-existing preset color.
 - The selected preset color is now updated.



- To apply a color to a specific RGBW output, locate the appropriate RGBW output.
- Tap the respective Edit icon.

NOTE — In the RGBW pop-up dialog box, the RGBW All Zones area is renamed to reflect the selected output.

Section 8

- Set the appropriate color options.



- To individually set colors for the remaining RGBW outputs, repeat the process.

Switching Outputs





- Locate the appropriate switching output(s):
 - Dock
 - Tower
 - Heater
 - Seat Heat





- To activate, tap the appropriate switching output(s).
- To deactivate, re-tap the appropriate switching output(s).

Surf Screen Tab Controls

Buttons exclusively on the Surf Screen page are shown in the table below.

ICON	DESCRIPTION
	<p>The P Tab Setpoint (Port) allows for setting the value (up and down arrows) of the left side of the vessel when facing the bow, or front, of the boat.</p> <p>NOTE – This feature is only available if the Surf Right or Quick Surf button is tapped.</p>
	<p>The C Tab Setpoint (Center) allows for setting the value (up and down arrows) of the center of the vessel. When speed reaches 20 MPH, C tab goes to 50%, when speed reaches 25+ mph C tab goes to 20%.</p>
	<p>The S Tab Setpoint (starboard) allows for setting the value (up and down arrows) of the right side when facing the bow, or front, of the ship.</p> <p>NOTE – This feature is only available if the Surf Left button is tapped.</p>
	<p>The Quick Surf feature automatically activates the Surf Right function, and applies an editable value for the P Tab Setpoint gauge (the port).</p>
	<p>The Quick Launch feature disables the Quick Surf function and only engages C tab.</p>

Section 8

ICON	DESCRIPTION
 A digital display interface showing a white boat icon on the left. To its right is a blue button labeled "SURF RIGHT". Below the boat icon, there is a speedometer showing "60" and a directional pad with an up arrow and a "0" value.	
 A digital display interface showing a white boat icon on the right. To its left is a blue button labeled "SURF LEFT". Above the boat icon, there is a blue button labeled "LAUNCH". Below the boat icon, there is a speedometer showing "90" and "60" with directional pads.	

From the main display, in the top navigation pane, tap the Surf icon (2nd symbol).



Save/Save As

- To set the appropriate options, tap Edit.
- To save the applied tab settings, tap Save.
- In the Save Tab Settings pop-up dialog box, tap Save As.
- The Profile page displays.
- In the Profile page, apply the appropriate settings.

NOTE — To gain a step-by-step understanding of how to apply the settings, please refer to the Profile Popup section.

- When finished, tap Save.

Profile Popup

From the main display, in the top navigation pane, tap the Profile icon (6th symbol).



Section 8

Create New

- To create a new profile, tap Add Rider.



- Tap the Name field.



- In the pop-up dialog box, enter the appropriate information.



- When finished, tap Enter.



- Tap the Quick Surf field until the desired option is displayed.



- Tap the Surf Tab field and locate the left-adjacent window.



- Enter the appropriate value and tap Enter.

NOTE — The field is now populated with the corresponding data.

Section 8



- Tap the Port Tab field and locate the left-adjacent window.



- Enter the appropriate value and tap Enter.

NOTE – The field is now populated with the corresponding data.



- Tap the Center Tab field and locate the left-adjacent window.



- Enter the appropriate value and tap Enter.

NOTE – The field is now populated with the corresponding data.



- Tap the Set Speed field and locate the left-adjacent window.



- Enter the appropriate value and tap Enter.

NOTE – The field is now populated with the corresponding data.

Section 8



- To locate additional options, simultaneously touch and scroll up on the Profile menu.
- To apply additional settings, repeat the previous steps.
- To save the profile, tap Save.
- The profile is now displayed.



Edit Profile



NOTE — Default profiles are uneditable.

- Locate and tap the appropriate profile.
- Tap Edit.
- Tap the appropriate field.

NOTE — To change the quick surf option, continuously tap the Quick Surf field to cycle through the options. All other field options require an entered value.

- Locate the left-adjacent window and enter the appropriate value.
- To confirm, tap Enter.
- The new value is now displayed in the corresponding field.
- When finished, tap Save.



Go Home Mode



NOTE — When the Go Home feature is selected, all ballasts will drain and cruise control will automatically set to 22 MPH.

- From the main display, in the top navigation pane, tap the Profile icon (6th symbol).
- Tap Go Home.
- The option is now activated.

Activate/Deactivate Profile



- Locate and tap the appropriate account. Note: Surf Left, Surf Right, Pro Surf Left and Pro Surf Right are default profiles.
- Once the profile is selected, the corresponding information will display.
- To activate the chosen profile, tap Activate.
- In the Change Profile pop-up dialog box, tap Yes.

NOTE — The Ramfill Fill Disabled pop-up dialog box will appear if the speed is not between 8-15 MPH. If this occurs, tap Ok to proceed.

- The profile is now activated!





NOTE — The applied profile may alter the RPM gauge, if the Set Speed value differs.

- To deactivate the profile, tap the active profile.
- Tap Deactivate.













Maps Screen Map Controls

Buttons exclusively on the Map page and pop-up window are shown in the table below:

ICON	DESCRIPTION
	To zoom in the map.
	To zoom out the map.
	To view your current location.
	To change the map orientation.

Section 8

ICON	DESCRIPTION
 A white location pin icon with a plus sign (+) to its right, set against a dark gray rounded square background.	To add a waypoint.
 A white icon representing a track (a curved line with a list of three horizontal lines) and a plus sign (+) below it, set against a dark gray rounded square background.	To add a track.
 A white icon showing a location pin, a track, and a list of three horizontal lines, set against a dark gray rounded square background.	To display a list of the waypoints and tracks.
 A white icon of a location pin centered within a circular crosshair, set against a dark gray rounded square background.	To orient to the assigned waypoint.
 A white icon of a location pin centered within a rounded square frame, set against a dark gray rounded square background.	To center the selected waypoint.

ICON	DESCRIPTION
	<p>To edit the waypoint/track name.</p>
	<p>To delete the selected waypoint or track.</p>
	<p>To toggle track visibility on/off.</p>
	<p>The Close icon in the pop-up window.</p>
	<p>The Waypoints tab in the pop-up window.</p>

Section 8

ICON	DESCRIPTION
	The Tracks tab in the pop-up window.

From the main display, in the top navigation pane, tap the Map icon (4th symbol).



Waypoints

Add a Waypoint



- From the Map page, locate the right-hand corner.
- Tap the Waypoint icon.
- In the pop-up dialog box, enter the appropriate information.
- When finished, tap Enter.

- The waypoint is now displayed on the Map page.



Tracks

Add a Track



- From the Map page, locate the right-hand corner.
- Tap the Track icon.
- In the pop-up dialog box, enter the appropriate information.
- When finished, tap Enter.
- The track is now added.



Popup



Waypoints

- From the Map page, locate the right-hand corner.
- Tap the Waypoint and Track List icon.
- The pop-up window is displayed on the Map page.

NOTE — In the pop-up window, there are 2 tabs: Waypoints & Tracks.

- Tap the Waypoints tab.
- To change the waypoint color, locate the appropriate waypoint.
- To cycle through color options, continuously tap the adjacent waypoint icon.
- The selected color will update on the map.
- The listed waypoints are displayed.
- Each waypoint has 4 corresponding options:
 - Orient to the waypoint (1st icon).
 - Navigate to the waypoint (2nd icon).
 - Rename the waypoint (3rd icon).
 - Delete the waypoint (4th icon).
- Apply the appropriate settings for the selected waypoint.

- When finished, tap the Close icon.

Tracks

- From the Map page, locate the right-hand corner.
- Tap the Waypoint and Track List icon.
- The pop-up window is displayed on the Map page.

NOTE — In the pop-up window, there are 2 tabs: Waypoints & Tracks.

- Tap the Tracks tab.
- The listed tracks are displayed.
- To change the track color, locate the appropriate track.
- To cycle through color options, continuously tap the adjacent track icon.
- The selected color will update on the map.
- Each track has 3 corresponding options:
 - Toggle the visibility on/off (1st icon).
 - Rename the track (2nd icon).
 - Delete the track (3rd icon).
- Apply the appropriate settings for the selected track.
- When finished, tap the Close icon.

Settings



General

- From the main display, in the top navigation pane, tap the Settings icon (7th symbol).
- In the Settings display, tap General.

NOTE — To scroll down the General display, simultaneously touch and scroll up.

Factory Reset

NOTE — Must have Restricted Settings activated.

- Locate and tap Factory Reset.
- In the Factory Reset pop-up dialog box, tap Confirm.
- In the proceeding Factory Reset pop-up dialog box, tap OK.
- Upon restart, the WSIA Information pop-up window will display.
- Tap Accept.
- The default settings are applied.

Change Unit Type

- In the General display, tap Units.
- Tap the appropriate metric option.

Change the Language

- In the General display, tap Language.
- 2 options are displayed:
 - English
 - Portuguese – Brazilian
- Tap the appropriate option.

Change the Clock

- In the General display, tap Clock.
- 3 options are provided:
 - Use GPS Time

NOTE — This feature is activated by default.

- ◆ Toggle on/off to (de)activate.

NOTE — If GPS Time is deactivated, Time Zone and Daylight Savings features disappear and 6 new settings populate:

- Set Hour
- Set Minute
- 12 Hour Time
- Set Day
- Set Month
- Set Year
- ◆ Tap the appropriate option.
- ◆ In the pop-up window, enter the appropriate value.

NOTE — 12 Hour Time is a toggle on/off feature.

- ◆ When finished, tap Enter.
- ◆ The value is now updated.
- ◆ To revert to the General display, to the Back icon.
- ◆ The Save pop-up dialog box automatically displays.
- ◆ To Save the applied settings, tap Save.

- Time Zone
 - ◆ Tap Time Zone.
 - ◆ In the Time Zone display, locate and tap the appropriate option.
- Daylight Savings
 - ◆ Toggle on/off to (de)activate.

AIS Inspection Mode

NOTE — This feature opens the gates to ensure that zebra mollusks are absent.

- In the General display, locate the AIS Inspection Mode feature.
- Toggle on/off to (de)active.

View the Software Version

NOTE — For troubleshooting purposes, the software version is important for manufacturers, dealers, or mechanics.

- In the General display, locate the Software Version feature.
- The corresponding installed software version is displayed.

Reboot to Loader

NOTE — This is a rescue-mode restart feature; switches the display into reboot mode; permits loading information onto the USB drive and to re-install software.

- In the General display, tap Reboot to Loader.

Restricted Settings

- In the General display, tap Restricted Settings.
- In the pop-up window, enter the appropriate passcode.
- When finished, tap Enter.

NOTE — Additional features will now populate in the Settings display:

- Demo Mode
- Dealer Options
- Reboot
- Debug
- Export File System

Demo Mode

NOTE — Restricted Settings must be activated.

- In the General display, locate the Demo Mode feature.
- Toggle on/off to (de)activate.

Dealer Options

NOTE — Restricted Settings must be activated.

- In the General display, tap Dealer Options.
- The Dealers Options display, reveals 5 options:

Section 8

- Switching
 - ◆ Tap Switching
 - ◆ 6 Options are displayed:
 - Interior Lights
 - Tower Lights
 - Underwater Lights
 - Docking lights
 - Heater
 - Seat Heater
 - ◆ Toggle on/off to (de)active.
 - ◆ To revert to the Dealer Options display, tap the Back icon.
 - ◆ The selected options will now appear in the right navigation pane on the main display.

NOTE — Activating Heater or Seat Heater will not reflect in the right navigation pane on the main display.

- RGBW
 - ◆ Tap RGBW
 - ◆ 2 options display:
 - None
 - RideController LED+
 - ◆ Tap the appropriate option.
- Customization

NOTE — This feature provides color customization options for the boat.

NOTE — This feature does not apply the color customization on the Ballast page.

- ◆ Tap Customization.
- ◆ 5 color customization options are displayed:
 - Hull Base Color
 - Hull Front Color
 - Upholstery Color
 - Tower Color
 - Trim Color

NOTE — These 9 color selections are offered for the hull color options:

- Onyx Black
- White Frost
- Whisper Gray
- Stone Gray
- Tan
- Mocha
- Pink Ribbon
- Electric Blue
- Too Lime

NOTE — For the Upholstery Color option, the previous color list applies, with additional colors included:

- Charcoal
- Too Red
- Castano Brown

NOTE — The Tower Color and Trim Color options offer 2 color selections:

- White
- Black
- ◆ Apply the appropriate settings.
- CATS Installed
 - ◆ Toggle on/off to (de)active.
- Camera Installed
 - ◆ Toggle on/off to (de)active.

Reboot

NOTE — Restricted Settings must be activated.

NOTE — Reboot is a simplified version of Reboot to Loader. It will only reboot the display.

- In the General display, tap Reboot.

Debug

NOTE — Restricted Settings must be activated.

NOTE — This feature shows all (dis)connected devices.

- In the General display, tap Debug.
- The (dis)connected devices are displayed:
 - PDMs
 - ◆ Tap the appropriate connected PDM
 - ◆ A spreadsheet displays pertinent information:
 - Name of all outputs
 - Status if the State is on/off
 - Fault state
 - Fuse value.
 - ◆ Legend color guide:
 - Red = digital inputs
 - Blue = analog inputs
 - Orange = output channels
 - Display
 - ◆ Tap Display.
 - ◆ The part number and serial number are displayed.
 - ◆ Also, a spreadsheet reveals the PIN, function, and notes for the connector.

- CAN Logger
 - ◆ This feature provides logging CAN data on either CAN 1 or CAN 2.
 - ◆ Tap CAN Logger.
 - ◆ In the JARDUM pop-up window, tap Start.
 - ◆ The ports begin incrementing.
 - ◆ To halt the logged data, tap Stop.
 - ◆ Plug in a USB thumb drive.
 - ◆ Tap the Download icon.
 - ◆ The CAN data has exported 2 files (port 1 and port 2) to the USB thumb drive.
 - ◆ To troubleshoot a feature, tap MIN.
 - ◆ When finished, tap the Clear icon.

NOTE — The JARDUM window must be maximized to close the window.

- Satellite Status
 - ◆ Refer to Map Settings > Satellite Status section.
- RideController LED+
 - ◆ Tap RideController LED+
 - ◆ The technical inputs and outputs are displayed.

Export File System

NOTE — Restricted Settings must be activated.

NOTE — This is a rescue-mode feature for software issues.

- Plug in a USB thumb drive.
- In the General display, tap Export File System.
- All software is now loaded onto the USB thumb drive.
- Now, software diagnostics can be performed, without the physical device being present.

Display

- In the Settings display, tap Display.
- A singular feature populates if Restricted Settings is not activated: Brightness.

NOTE — Auto-Brightness feature appears once Restricted Settings are active.

- Locate the Brightness button.
- Navigate to the corresponding brightness value.
- Adjacent negative and positive buttons display.
 - Each tap adjusts the brightness by 5 increments.
- Set the appropriate options.
- Tap Auto-Brightness
- 2 options are displayed:

- GPS Auto-Brightness
- Ambient Auto-Bright
- Toggle on/off to (de)active the selected option.
- To revert to the General display, tap the Back icon.

Map Settings



- In the Settings display, tap Map.
- The Map settings page displays 10 options:
 - Satellite Status
 - ◆ Tap Satellite Status
 - ◆ The Satellite Status pop-up window displays the number of satellites and GPS puck status.
 - ◆ To exit, tap the Close icon.
 - Show Tracks
 - ◆ Toggle on/off to show or hide.
 - Show Waypoints
 - ◆ Toggle on/off to show or hide.
 - Maps Color

NOTE — This feature changes the background color of the map display.

- ◆ Tap Maps Color

NOTE — There are 3 options:

- Blue
- White
- Black
- ◆ Tap the appropriate option.
- Safety Contours

NOTE — This feature permits users to modify the contour depth.

- ◆ Tap Safety Contours
- ◆ Locate the corresponding ft value.

Section 8

NOTE — adjacent negative and positive buttons appear.

- ◆ Tap the negative button to decrease the value.
- ◆ Tap the positive button to increase the value.

NOTE — Re-tapping either button will also display the Off option.

- Depth Contours

NOTE — This feature permits users to modify the contour resolution.

- ◆ Tap Depth Contours.
- ◆ Locate the corresponding value.

NOTE — Adjacent negative and positive buttons appear.

- ◆ Tap the negative button to decrease the value.
- ◆ Tap the positive button to increase the value.

NOTE — Re-tapping the either button will also display the All option.

- Import Tracks
 - ◆ Need a thumb drive for importing.
- Import Waypoints
 - ◆ Need a thumb drive for importing.
- Export Tracks
 - ◆ Need a thumb drive for exporting.
- Export Waypoints
 - ◆ Need a thumb drive for exporting.

Engine

- In the Settings display, tap Engine.

NOTE — To scroll down the Engine display, simultaneously touch and scroll up.

- The Engine display, reveals useful information:
 - Engine Hours
 - Engine Data Source
 - CAN 1 Bit Rate
 - CAN 2 Bit Rate
 - CAN 1 Termination (Appears when Restricted Settings is activated)
 - Fuel Reading

NOTE — The respective value is displayed on the right-hand side.

NOTE — To edit the listed features, activate Restricted Settings.

- To access the fuel reading, tap Fuel Setup.
- The fuel reading is now displayed.
- To revert to the Engine display, tap the Back icon.

PDM

- In the Settings display, tap PDM.
- The PDM display lists the number of configured PDMs.
- A button titled Number of PDMs is displayed with a corresponding value.
- All PDMs are displayed with their respective button.
- Tap the appropriate PDM.
- Each output for the selected PDM is displayed.
- Tap the appropriate output.
- Set the appropriate options.
- When finished, tap Save.
- In the Save pop-up dialog box, tap Confirm.
- To revert to the Output display, tap the Back icon.

Wake

- In the Settings display, tap Wake.
- 7 wake configuration options are displayed:
 - Port Ballast
 - Starboard Ballast
 - Center Ballast
 - Bow Ballast
 - Transom ballast
 - Port Ramfill
 - Starboard Ramfill

NOTE — The proceeding steps apply to all wake configurations.

- Tap the appropriate wake configuration option:
- 3 options are displayed:
 - Toggle on/off to (de)active the selected option
 - Ballast Empty Time
 - ◆ Sets the timer from 100% full to 0% empty
 - Ballast Fill Time
 - ◆ Sets the timer from 0% empty to 100% full.

CENTURION NV CONFIGURATION



DISPLAY

Home Screen



NOTE — In the right navigation pane, when an icon is tapped, the corresponding information will display.





Tab Controls

ICON	DESCRIPTION
	<p>Tap the up or down arrows to adjust the Center Tab controls.</p>
	<p>In the RPM analog gauge area, under MPH, tap OFF to toggle ON cruise control (the button will turn green when active) and re-tap to deactivate cruise control. Tap the negative or plus icons to adjust the speed.</p>





Section 8

Gauges

The gauges are shown in the table below. Note: Besides the RPM analog, all of the listed gauges are displayed on all pages: Home, Surf, Ballast, Maps, Lighting, Profile, Settings.

ICON	DESCRIPTION
 An analog-style gauge with a black face and white markings from 0 to 7. The needle points to 12.2. The text '12.2 MPH' is displayed in the center. Below the gauge is a green control bar with a minus sign, a refresh icon, '12.2', and a plus sign.	RPM analog
 A digital display showing '1750 RPM' in white text on a black rectangular background.	RPM digital
 An icon representing water depth, consisting of four wavy lines and a vertical double-headed arrow.	Water depth
 An icon representing water temperature, consisting of four wavy lines and a thermometer.	Water temperature

Helm and Controls

ICON	DESCRIPTION
 A grey icon of a fuel pump nozzle and its handle.	Fuel
 A grey icon of a battery with a plus sign on the left and a minus sign on the right.	Battery
 A grey icon of a thermometer with a bulb at the bottom and a scale on top, floating in water.	Engine temperature
 A grey icon of an oil can with a spout and a handle.	Oil
 A green icon of a boat with an anchor, surrounded by radiating lines, indicating a signal or status.	Nav anchor state

Section 8

Ballasts Screen

From the main display, in the right navigation pane, tap the Ballast icon (3rd symbol).



Ballast Controls

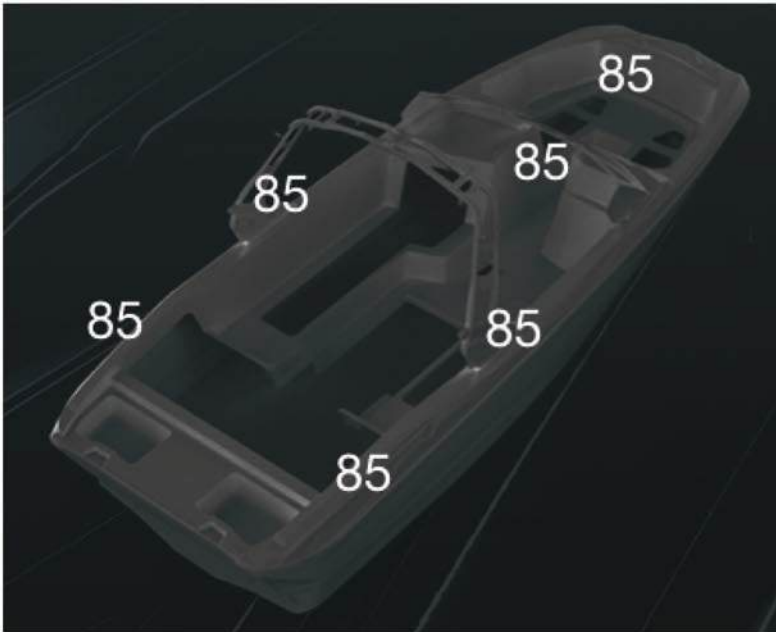

Trailer Mode

- From the Ballast page, tap Trailer Mode.
- The Trailer Mode pop-up dialog box displays open and close options to the fill or drain gates.

NOTE — The trailer mode should only be used when the boat is out of the water. Make sure to close the gates before launching.

- Locate the Fill Gates area and tap Open or Close.
- Locate the Drain Gates area and tap Open or Close.

NOTE — Under the Open and Close buttons in Fill Gates and Drain Gates area, a message displays if both gates are opened or closed.

- Gates will automatically close when the engine is turned on.
- When finished, tap Done.

Ramfill Ballasts



- To select a specific ballast, tap the appropriate ballast.

NOTE — The selected ballast will reflect in the ballast gauge.

- To fill the selected ballast, tap Fill.

NOTE — To halt the fill, tap Stop.

- To drain the selected ballast, tap Drain.

NOTE — To halt the drain, tap Stop.

- To simultaneously fill the ballasts, tap Fill All.

NOTE — The Ramfill Fill Disabled pop-up dialog box will appear if the boat speed is not between 8-15 MPH.

- To simultaneously drain all the ballasts, tap Drain All.

NOTE — The Ramfill Drain Disabled pop-up dialog box will appear if the boat speed is not between 8-23 MPH.

- When filling or draining options are selected, a Stop All button will appear. To halt, all ballasts from filling or draining, tap Stop All.

Section 8

Switching Screen

From the main display, in the right navigation pane, tap the Lighting icon (5th symbol).

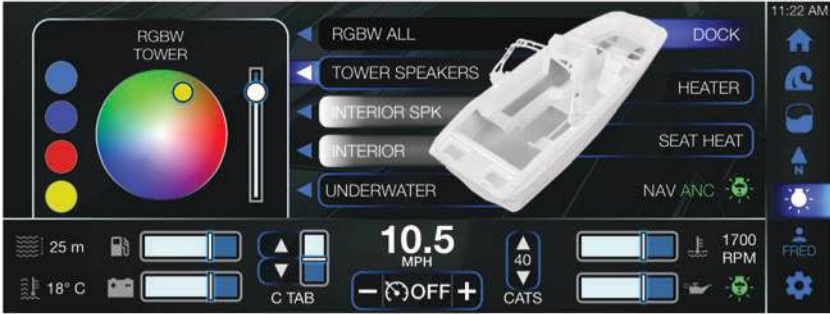

RGBW Outputs

- Locate the appropriate RGBW output(s):
 - RGBW All (applying the same color for all outputs)
 - Tower Speakers
 - Cockpit SPK
 - Interior
 - Underwater
- Tap the adjacent left arrow.
- In the RGBW area, set the appropriate color with either one of the presets or the color wheel and brightness slider:
 - To quickly apply a color, locate the 4 preset color options.
 - Tap the appropriate color.
 - Alternatively, to apply a custom color, simultaneously touch and slide the circle on the color wheel to the appropriate color.
 - To adjust the brightness, simultaneously touch and slide the brightness slider to the appropriate setting.



NOTE — The selected color will reflect on the RGBW output button. If the outputs have different colors applied, the RGBW ALL button will display a color gradient.



Switching Outputs

- Locate the appropriate switching output(s):
 - Dock
 - Heater
 - Seat Heat







- To activate, tap the appropriate switching output(s).
- To deactivate, re-tap the appropriate switching output(s).

Section 8

Surf Screen Tab Controls

Buttons exclusively on the Surf Screen page are shown in the table below.

ICON	DESCRIPTION
	<p>The P Tab Setpoint (Port) allows for setting the value (up and down arrows) of the left side of the vessel when facing the bow, or front, of the boat.</p> <p>NOTE — This feature is only available if the Surf Right or Quicksurf button is tapped.</p>
	<p>The C Tab Setpoint (Center) allows for setting the value (up and down arrows) of the center of the vessel. 75% at 18 MPH, 50% at 21 MPH, 20% at 25 MPH.</p>
	<p>The S Tab Setpoint (starboard) allows for setting the value (up and down arrows) of the right side when facing the bow, or front, of the ship.</p> <p>NOTE — This feature is only available if the Surf Left button is tapped.</p>
	<p>The Quicksurf feature automatically activates the Surf Right function, and applies an editable value for the P Tab Setpoint gauge (the port).</p>
	<p>The Quick Launch feature disables the Quick Surf function and only engages C tab</p>

Helm and Controls

ICON	DESCRIPTION
	<p>Surf Right shifts the boat on the right and enables the P Tab Setpoint (Port) C Tab Setpoint (Center) options.</p>
	<p>Surf Left shifts the boat on the left and enables the C Tab Setpoint (Center) and S Tab Setpoint (starboard) options.</p>
	<p>The Save As button saves all applied settings into a profile. This profile becomes a template that can be reused.</p>

From the main display, in the right navigation pane, tap the Surf icon (2nd symbol).



Section 8

Save/Save As

- Set the appropriate options.
- To save the applied tab settings, tap Save As.
- In the Save Tab Settings pop-up dialog box, tap Save As.
- The Profile page displays.
- In the Profile page, apply the appropriate settings.

NOTE — To gain a step-by-step understanding of how to apply the settings, please refer to the Profile Popup section.

- When finished, tap Save.

Profile Popup

From the main display, in the right navigation pane, tap the Profile icon (6th symbol).



Create New

- To create a new profile, tap Add Rider.



- Tap the Name field.

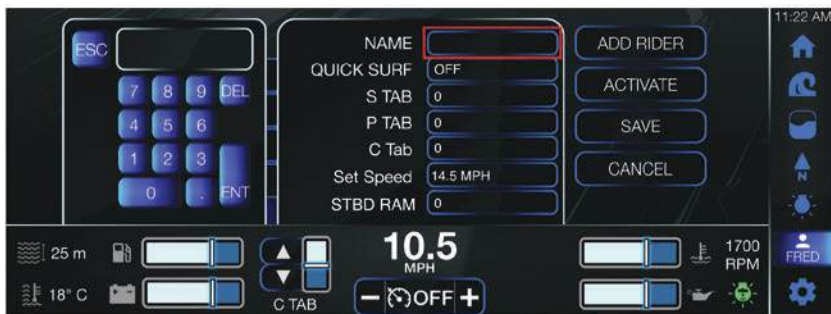

- In the pop-up dialog box, enter the appropriate information.



- When finished, tap Enter.



Section 8

- Tap the Quick Surf field until the desired option is displayed.

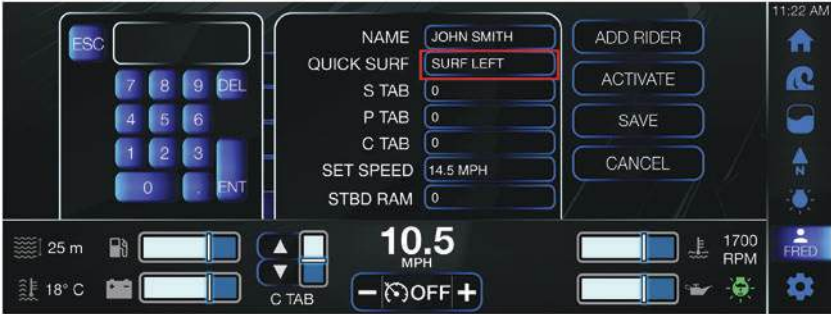

- Tap the Surf Tab field and locate the left-adjacent window.



- Enter the appropriate value and tap Enter.

NOTE — The field is now populated with the corresponding data.

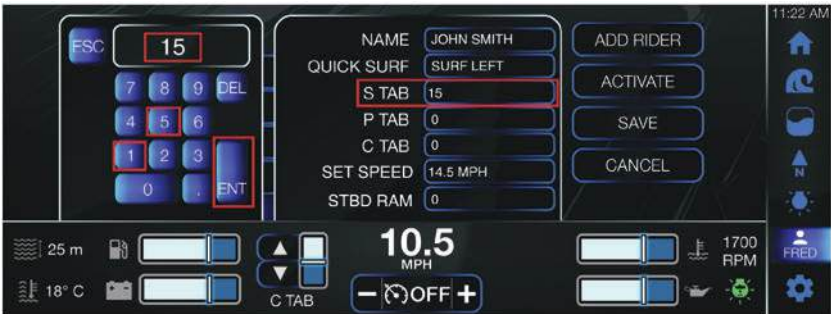

- Tap the P (Port Tab) field and locate the left-adjacent window.

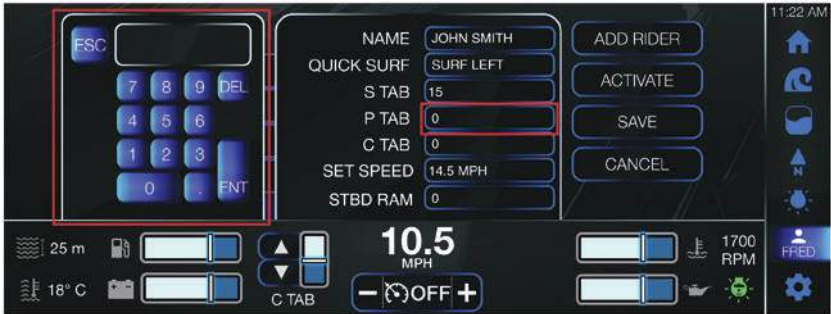

- Enter the appropriate value and tap Enter.

NOTE — The field is now populated with the corresponding data.

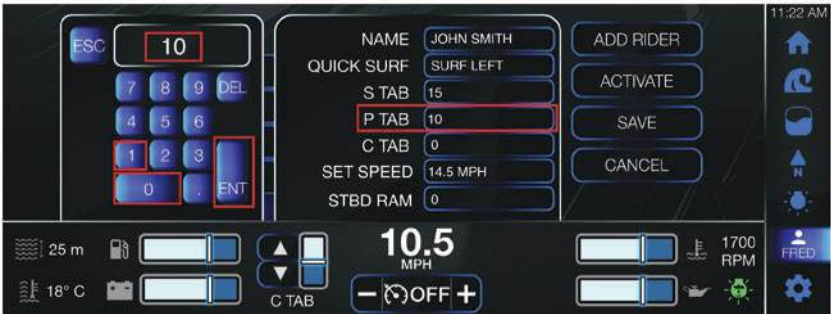

- Tap the C (Center Tab) field and locate the left-adjacent window.

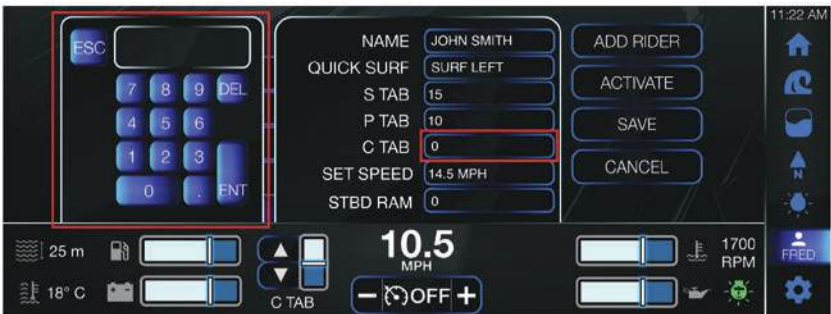

- Enter the appropriate value and tap Enter. Note: The field is now populated with the corresponding data.

Section 8

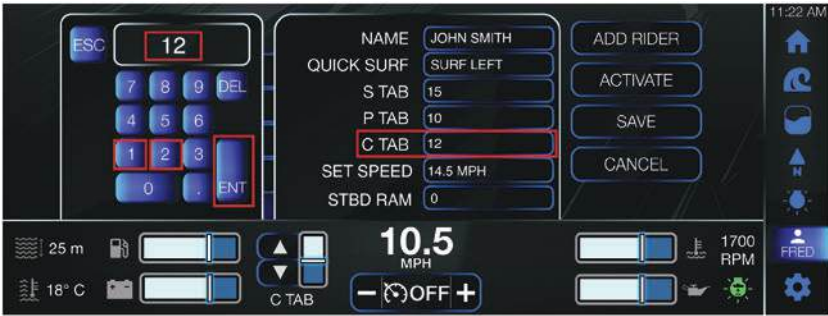

- Tap the Set Speed field and locate the left-adjacent window.

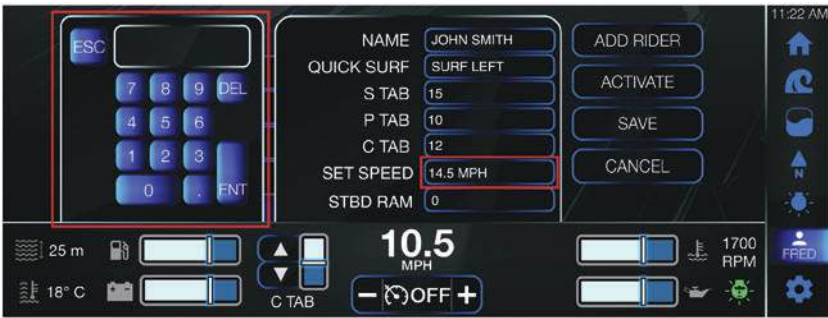

- Enter the appropriate value and tap Enter.

NOTE — The field is now populated with the corresponding data.

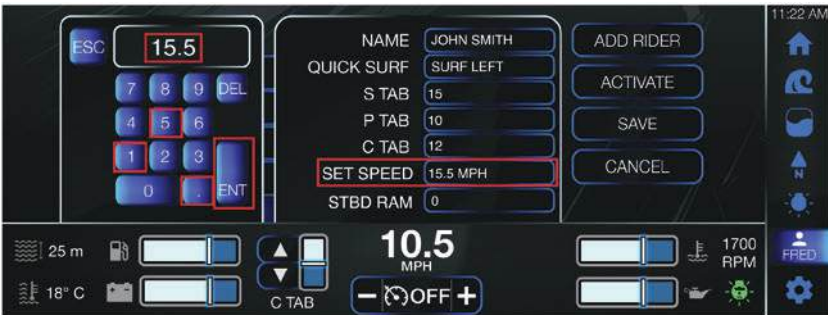

- Tap the STBD RAM field and locate the left-adjacent window.

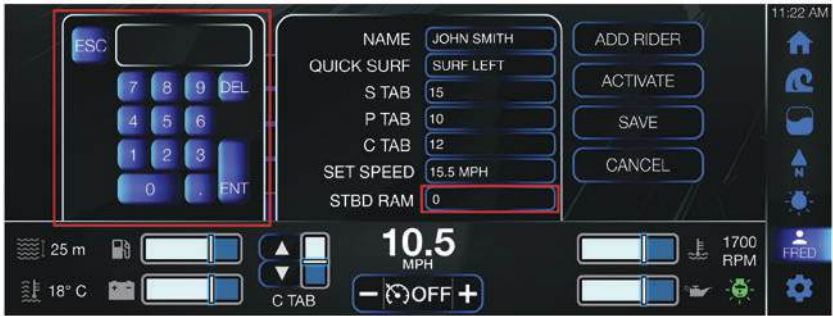

- Enter the appropriate value and tap Enter.

NOTE – The field is now populated with the corresponding data.

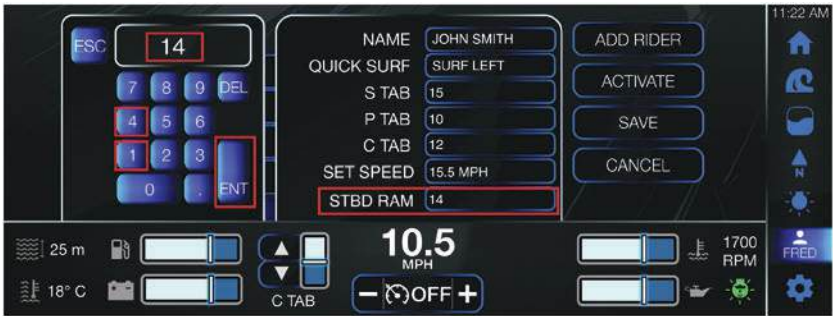

- To locate additional options, simultaneously touch and scroll up on the Profile menu.
- To apply additional settings, repeat the previous steps.
- To save the profile, tap Save.
- The profile is now displayed.

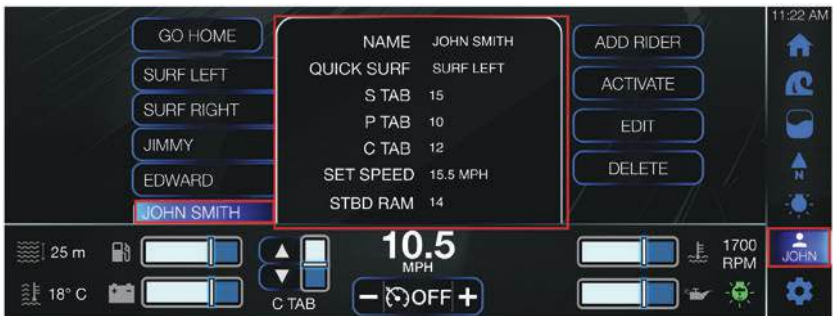

Section 8

Edit Profile



NOTE — Default profiles are uneditable.

- Locate and tap the appropriate profile.
- Tap Edit.
- Tap the appropriate field.

NOTE — To change the quick surf option, continuously tap the Quick Surf field to cycle through the options. All other field options require an entered value.

- Locate the left-adjacent window and enter the appropriate value.

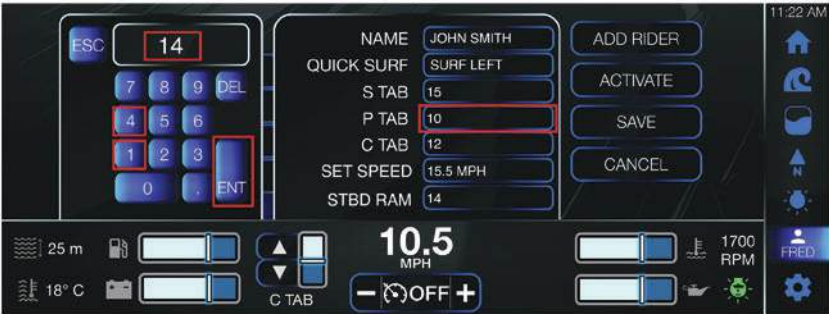

- To confirm, tap Enter.
- The new value is now displayed in the corresponding field.

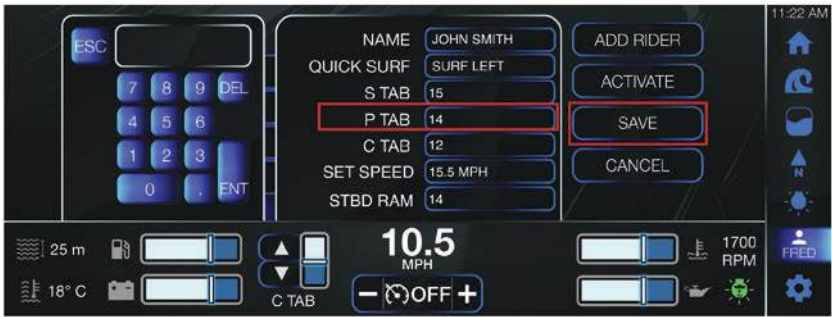

- When finished, tap Save.

Go Home Mode

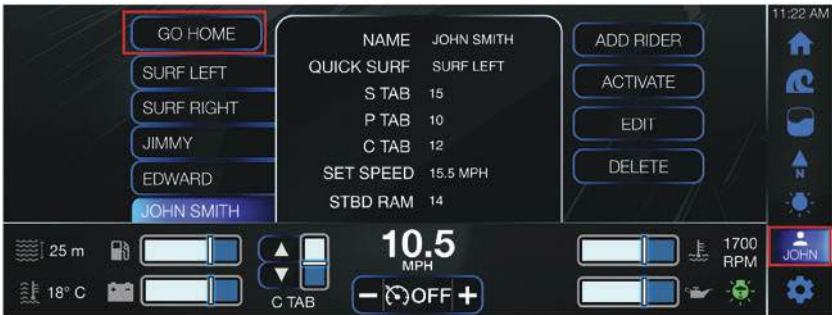

NOTE — When the Go Home feature is selected, all ballasts will drain and cruise control will automatically set to 22 MPH.

- From the main display, in the right navigation pane, tap the Profile icon (6th symbol).
- Tap Go Home.
- The option is now activated.

Activate/Deactivate Profile

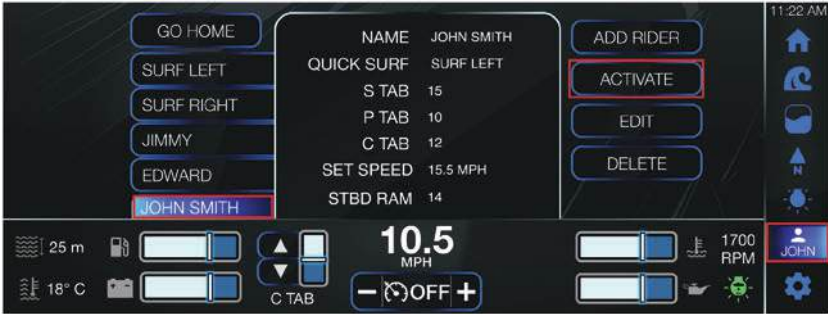

- Locate and tap the appropriate account. Note: Surf Left, Surf Right, Pro Surf Left and Pro Surf Right are default profiles.
- Once the profile is selected, the corresponding information will display.
- To activate the chosen profile, tap Activate.
- In the Change Profile pop-up dialog box, tap Yes.



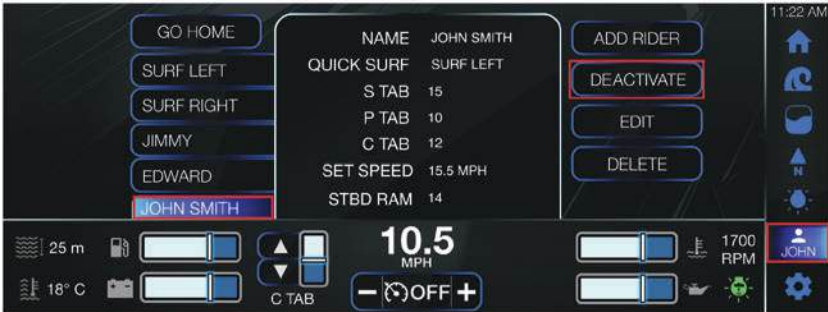

NOTE — The Ramfill Fill Disabled pop-up dialog box will appear if the speed is not between 8-15 MPH. If this occurs, tap Ok to proceed.

- The profile is now activated! To deactivate the profile, tap the active profile.
- Tap Deactivate.













Maps Screen Map Controls

Buttons exclusively on the Map page and pop-up window are shown in the table below:

ICON	DESCRIPTION
	To zoom in the map.
	To zoom out the map.
	To view your current location.
	To change the map orientation.

Section 8

ICON	DESCRIPTION
	To add a waypoint.
	To add a track.
	To display a list of the waypoints and tracks.
	To locate a track.
	To assign the track to the selected waypoint.

ICON	DESCRIPTION
	<p>To edit the waypoint/track name.</p>
	<p>To delete the selected waypoint or track.</p>
	<p>To toggle track visibility on/off.</p>
	<p>The Close icon in the pop-up window.</p>
	<p>The Waypoints tab in the pop-up window.</p>

Section 8

ICON	DESCRIPTION
	The Tracks tab in the pop-up window.

From the main display, in the right navigation pane, tap the Map icon (4th symbol).



Waypoints

Add a Waypoint



- From the Map page, locate the right-hand corner.
- Tap the Waypoint icon.
- In the pop-up dialog box, enter the appropriate information.
- When finished, tap Enter.
- The waypoint is now displayed on the Map page.



Tracks

Add a Track



- From the Map page, locate the right-hand corner.
- Tap the Track icon.
- In the pop-up dialog box, enter the appropriate information.
- When finished, tap Enter.
- The track is now added.

Popup



Waypoints

- From the Map page, locate the right-hand corner.
- Tap the Waypoint and Track List icon.
- The pop-up window is displayed on the left-side of the Map page.

NOTE — In the pop-up window, there are 2 tabs: Waypoints & Tracks.

- Tap the Waypoints tab.
- The listed Waypoints are displayed.
- Each waypoint has 4 corresponding options:
 - Locate a track (1st icon).
 - Assign the track (2nd icon).
 - Rename the waypoint (3rd icon).
 - Delete the waypoint (4th icon).
- Apply the appropriate settings for the selected waypoint.
- When finished, tap the Close icon.

Tracks

- From the Map page, locate the right-hand corner.
- Tap the Waypoint and Track List icon.
- The pop-up window is displayed on the left-side of the Map page.

NOTE — In the pop-up window, there are 2 tabs: Waypoints & Tracks.

- Tap the Tracks tab.
- The listed tracks are displayed.
- Each track has 3 corresponding options:
 - Toggle the visibility on/off (1st icon).
 - Rename the track (2nd icon).
 - Delete the track (3rd icon).
- Apply the appropriate settings for the selected waypoint.
- When finished, tap the Close icon.

Menu



Dealer Settings

- In the right navigation pane, tap the Settings icon (7th symbol).
- In the Settings display, tap General.
- Scroll down, to locate and tap Dealer Options.

NOTE — There are 4 customization options:

- Switching lighting outputs:
 - ◆ Interior lights
 - ◆ Tower lights
 - ◆ Underwater lights
 - ◆ Docking lights
 - ◆ Heater
 - ◆ Seat heater
- Enable or disable RGBW:
 - ◆ Activate/deactivate RideController LED+
- Customization:
 - ◆ Change boat color
- Camera:
 - ◆ Activate/deactivate
- Locate and set the appropriate options.

This Page Intentionally Left Blank

CENTURION BOATS

Section 9

FEATURES AND OPTIONS

This section includes general and specific information about major systems and components that may be standard, optional or not applicable on your boat. For specific information on the systems and components in your boat, see your local Centurion dealer.

TOW BOAT TECHNOLOGY

Your boat may be equipped with one or more of the following features engineered specifically for towing.

CENTURION ARTICULATING TRACKING SYSTEM (CATS)

What it does:

Through the steering column lever or Touch Vision screens, the CATS fin articulates under the boat on command. While the boat is underway, the CATS fin can be manipulated into the position desired to change the direction of water flow, helping the driver create a better surf and wakeboard wave. The CATS fin also allows the driver to level the boat even with an offset in weight.

How it Works:

The tracking fin that moves under the boat is positioned through a cutout in the gas tank. The rod that sticks through the boat is attached to a ram that moves the fin right or left. The ram is controlled by one of the 3 PDMs in the boat. The touch screen relays a signal to the computer to know when you, the driver, want to position the CATS differently.

See Section 8 - Helm and Controls for operation.

BALLAST TANK PLUMBING AND PUMPS

Centurion uses Jabsco Ballast Puppy pumps. There are 4 optional pumps located in the transom area of the bilge. All 4 pumps are located on the transom of the boat. This keeps the pumps secured and easy to access. The four optional pumps available on your Centurion are bow plug n' play, center hard tank, and port and starboard rear plug n' plays. The pumps are reversible so you can add water to your ballast tank or take away water with the same pump. The 1" flow allows for approximately 80 pounds of water ballast per minute.



BALLAST TANK SYSTEM (OPTIONAL)

The purpose of ballast tanks is to add weight to the boat in designated areas to help produce larger wakes for water sport activities, such as wakeboarding and wakesurfing.

The ballast system consists of water tanks, pumps, seacocks, hardware and controls. Panel-mounted switches activate water pumps that fill and drain the tanks with seawater. Seacocks are used to open and close seawater drains.

 DANGER *Never add additional ballast. Additional ballast can make a boat unsafe and illegal to operate.*

⚠ WARNING *When the ballast tanks are filled, reduce the total weight in the boat. By adding ballast, the boat becomes heavier and fewer passengers and/or gear are allowed in order to keep the boat within legal and safe weight limits. The average passenger weighs 141 lb (64 kg). Water weighs approximately 8.4 lb per gallon (1 kg per liter). Fuel/gasoline weighs approximately 6.3 lb per gallon (0.75 kg per liter).*

See Section 8 - Helm and Controls for ballast tank system operation.

Ri245 Ballast Tank Locations

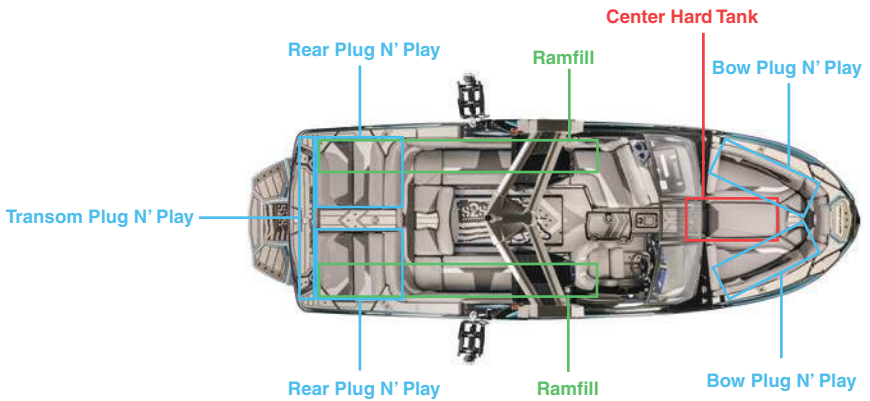

Fe23 Ballast Tank Locations

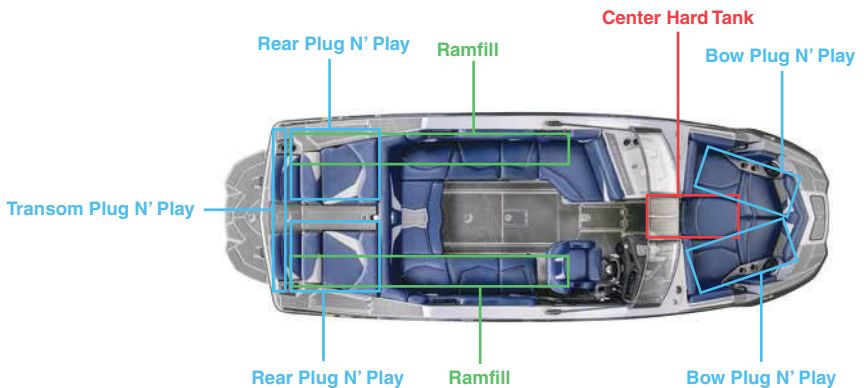

Nv Ballast Tank Locations

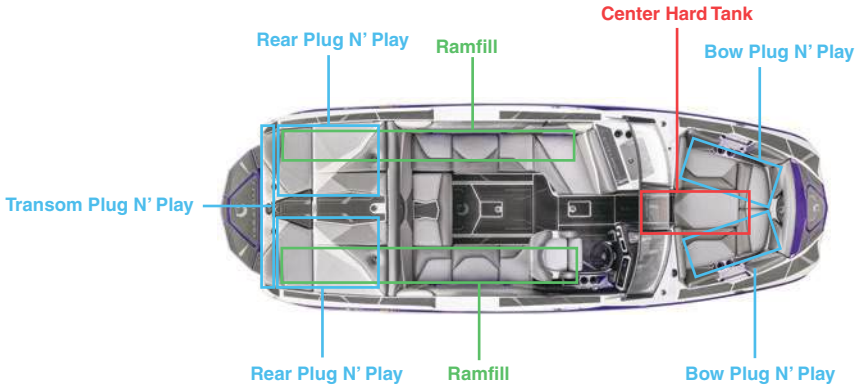

RAMFILL

Ramfill is a ballast system integrated into the hull liner that is quick to fill and quick to drain, without the need for pumps or sacs. The system consists of an underwater scoop, side air vents and drain valves, and is controlled and monitored by the Touch Vision II system with Side-by-Side touch screen. The ballast system will vent air and overfill water out the side vents of the boat, and is emptied from the transom drains.

See Section 8 - Helm and Controls for operation.

Ramfill System



RAMFILL BALLAST OPERATION

The Ramfill ballast system valves will not open unless the boat is over 10 mph and under 25 mph. The faster the boat speed (20-25 mph), the faster the fill and drain. The Ramfill system is controlled by the Touch Vision Side-by-Side Dash display. See the Touch Vision Operator's Manual for more information.

To fill the ballast tank:

1. Navigate the boat to open water that is free of other traffic.
2. Pull up the Ramfill menu on the Touch Vision display.
3. Select a pre-set or manual fill option.
4. Shift to Forward and accelerate to between 10 and 25 mph.
5. When the ballast tank levels shown on the Touch Vision display reach the desired level, turn Ramfill off.
6. The boat is now ready for tow sports.

To drain the ballast tank:

1. Navigate the boat to open water that is free of other traffic.
2. Pull up the Ramfill menu on the Touch Vision display.
3. Select the Ramfill Drain option.
4. Shift to Forward and accelerate to between 10 and 25 mph.
5. When the ballast tank levels shown on the Touch Vision display show empty, turn Ramfill off.

PLUG N' PLAY BALLAST SYSTEM

The Plug N' Play Ballast system uses four transom-mounted pumps that are reversible for filling/draining. The pumps enable four separate ballast tanks to be filled or drained independently. The pumps are marked on top as to what ballast tank they fill/drain. The pumps fill/drain three soft bagged FATSAC ballast sacs (one located in the bow of the boat and two located in the rear port and starboard motor compartments). The fourth ballast pump fills/drains the center hard tank which is located subfloor under the walk-over ice chest.

TRIM TAB / STINGER WAKE PLATE (OPTIONAL)

Trim tabs are either power or manually controlled. (Equipment will vary by model and options.) A powered trim tab is controlled from the helm by a switch and use of a position indicator. A cavitation plate is controlled by manually adjusting the plate adjustment rods to a predetermined position.

A trim tab enhances the planing ability of the boat. When used on inboard ski boats a single trim tab enhances and controls the type of wake desired by controlling the hull running attitude.

By controlling the wake characteristics, wakes can be made to enhance water sports such as wakeboarding, barefooting, kneeboarding and towables.

Section 9

A single tab is usually mounted in the center rear of the hull. Tab movement is controlled from a helm-mounted switch, which activates an electric or electric/hydraulic actuator attached to the tab.

When operating at wakeboarding speeds, with the trim tab in the UP position, the bow rises and the hull rides normally, creating heavy water displacement and large wakes.

When operating at skiing speeds, with the trim tab in the DOWN position, the bow lowers and helps the boat to plane quickly for skiing and slalom skiing-type wakes and allows for pulling more and/or heavier skiers.

See the *Trim Tab Operator's Manual* for additional information.

Typical Power Trim Tabs and Smart Rams



QUICKSURF PRO

QuickSurf Pro is a wakesurf system attached to each side of the transom used for making and shaping the surf wave. The plates, which can be adjusted to different angles, allow for a controlled wave size and shape.

On an equally weight-distributed surf boat, the system can allow for a driver to shift a surf wave from port to starboard with just a press of a button on the Touch Vision II system with the Side-by-Side screen. The QuickSurf Pro can be used in combination with the stinger wake plate to tune the wave, or QuickLaunch to get the boat to plane quickly without bow rise.

See *Section 8 - Helm and Controls* for operation.

QuickSurf Pro



STINGER WAKE PLATE

The Stinger plate is a large center plate located off the transom of the boat. The plate helps produce lift during the QuickLaunch sequence. The plate also helps form a more steep or mellow wakeboard/surf wave depending on the location of the plate in the up or down position.



SILENT STINGER WAKE PLATE

The optional Silent Stinger wake plate operates the same as the standard stinger plate except that the engine exhaust is routed to the plate, further diffusing the exhaust note with water.



WAKE TOWER (OPTIONAL)

Wake towers are used to provide a higher towing point for water sports and to mount lights and other accessory equipment. Towers are solidly constructed from stainless steel or aluminum and are mounted solid to the boat. Some towers may have an optional folding feature, which allows the tower to be folded for storage or clearance.

⚠ WARNING *Misuse or overloading of the wake tower can cause death or serious injury. The wake tower is designed for water sports only. DO NOT use for towing other watercraft, parasailing, kite flying or towing tubes or other similar towables. Read the safety decal on the wake tower before using and DO NOT overload the tower's weight rating.*

BATTLE ADVANCE TOWER

The Battle Advance Tower by Roswell provides winning functionality with the strength and ease of a front fold along with perfectly placed LED lighting and an optional bimini system that will shade you and your entire family in 60 seconds flat. It is that easy to put up.

 **CAUTION** *The Battle Advance Tower is not designed to pull Inflatables*.*

See separate Battle Advance Tower owner's manuals for operation and accessory details.

DROPZONE AUTO TOWER

The DropZone Auto Tower by Roswell folds quick and smooth with the push of a button thanks to floating Linear Actuators. The DropZone offers even more function with thoughtful touches like surf-side tow points and hangers. It also provides 40% more strength thanks to the water drop extruded construction that complements the lines of Centurion boats perfectly.

 **CAUTION** *The Dropzone Auto Tower is not designed to pull Inflatables*.*

See separate DropZone Auto Tower owner's manuals for operation and accessory details.

PREDATOR POWER TOWER

The Predator Power Tower by Roswell utilizes four Linear Actuators to raise or lower its nine-foot-long bimini in around 20 seconds. No matter what time of day you are out riding with your family, you will be covered from the sun or any rain that comes your way. No matter what height it is at, the rigid bimini will stay parallel to the deck allowing for it to be kept open when towing your boat or storing it away. This top-of-the-line tower is an eye catcher due to its customizability with its variety of accent colors, its speakers, and other accessories.

 **CAUTION** *The Predator Power Tower is not designed to pull Inflatables*.*

See separate Predator Power Tower owner's manuals for operation and accessory details.

STEERING SYSTEM

! WARNING *Control Hazard: Be sure to inspect the outboard's steering system for damage after striking an underwater object. Stop immediately to inspect for damage that may result in loss of steering control.*

! WARNING *Control Hazard: Improper maintenance of steering system is hazardous and can cause death or serious injury from sudden loss of control. Ensure all steering hardware, cables and grease fittings are regularly inspected and maintained. If any steering problems are noticed, do not operate the boat and contact your dealer immediately for service assistance.*

The boat may be equipped with one of four different steering systems: mechanical, hydraulic, electric, or electronic. Check steering for smooth operation before each use; if the steering is difficult or binding, do not operate the boat.

MECHANICAL STEERING

This system uses a push-pull cable connected between the steering wheel and the steering link. Some propulsion units provide a connection for hydraulic assist.

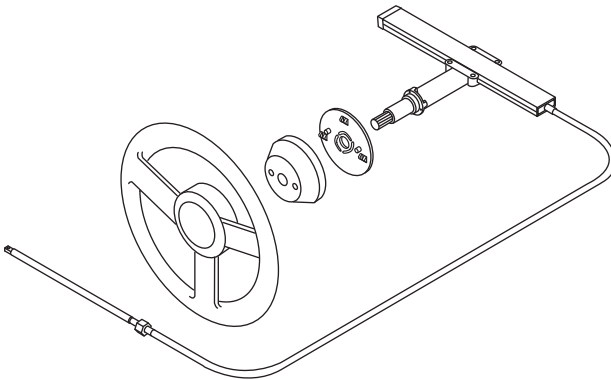

KC-0268-A

HYDRAULIC STEERING

The boat may be equipped with optional hydraulic steering for easier control of higher horsepower outboards. This system uses a pump built into the steering wheel and hoses connected between the pump and a cylinder attached to the outboard steering link. Turning the wheel pumps hydraulic fluid to the cylinder to turn the engine.

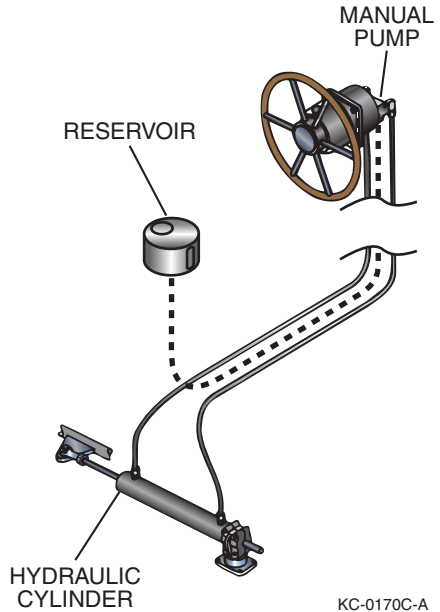

ELECTRIC STEERING

The boat may be equipped with optional electrical steering for easier control of the most powerful outboards and twin installations. Sensors in this system's steering wheel send signals to an electric motor connected to the outboard steering link to turn the engine. Some electric steering systems are integrated into the outboard engine. See the *Engine Operator's Manual* or steering manufacturer's information for safety and maintenance instructions.

ELECTRONIC STEERING

The boat may be equipped with an optional electronic steering system provided with the most advanced propulsion units. Most systems use a helm-mounted unit with a steering wheel that controls a cylinder mounted to the drives, outboards or rudder. Tilt the steering wheel by activating the tilt lock lever located on the bottom side of the helm unit and it automatically locks when released at or close to that angle.

Electronic or steer-by-wire systems consist of an electronic helm unit, helm-mounted display screen, aft-mounted pump control module, aft-mounted hydraulic pump/reservoir and drive/rudder-mounted hydraulic cylinder. The electronic components communicate over a data network to control the hydraulic pump to operate the cylinder and steer the boat. Open the integral service valve on the steering pumps to bypass the pumps for service or in case of emergency. Refer to the *Steering Manufacturer's Owner's Manual* for more information.

Section 9

Electronic steering systems are required for special automation such as optional joystick steering or docking assist systems. Most electronic steering systems allow for multiple stations and easy integration with NMEA 2K-compatible joystick controls and autopilots. These systems can be dealer-programmed to adjust outboard engine-toe and turning ratio and contain built-in redundancy and safety features. See your dealer or contact the propulsion manufacturer for retrofit information.

NOTICE

The drives must be aligned to provide maximum stability on straight-ahead runs and proper tracking through cornering. Damage to the drives or steering system may require the drives to be realigned by the dealer. Refer to the Propulsion Manufacturer's Owner's Manual for specific information.

FUEL SYSTEM

Basic fuel systems consist of one or more fuel tanks, tank vents, a level sensor and gauge, lines, pumps and valves.

Each tank has an antisiphon valve to prevent fuel from leaking out of the tank should a break occur in the system at a point other than the tank.

ENGINE COOLING SYSTEM

Marine inboard engines may be cooled in different ways. Depending on your engine application, an open or self-contained cooling system may be used.

An open cooling system uses raw water (seawater) to cool the engine and/or drive system. A continuous flow of raw water transfers heat from the engine and drive cooling passages and is then returned to the sea. A seacock and raw water pickup on the hull allow water into the engine, and a pump then circulates the water to cool the engine.

A self-contained/closed cooling system uses raw water to cool the engine and/or drive system through the use of a heat exchanger. A continuous flow of raw water is used to transfer heat from the heat exchanger to cool the engine and drive coolant. The engine cooling passages and heat exchanger passages are self-contained/closed, similar to an automotive cooling system. Heat is transferred from the engine and drive to the coolant and circulated through the heat exchanger in the closed system. A separate raw water passage in the heat exchanger transfers heat from the self-contained engine coolant to the raw water. The raw water is then returned to the sea. Most self-contained heat exchangers are equipped with sacrificial anodes for corrosion protection and must be replaced periodically. See the *Engine Manufacturer's Operator's Manual* for specific details.

Raw water intakes on the hull use a seacock to provide manual shutoff if a leak occurs. Periodically inspect the raw water intake screen (if equipped) and clear it of debris that could obstruct water flow into the engine.

NOTICE

Keep seacocks closed during periods of inactivity. A downstream hose failure could flood the boat if the seacock is left open. Open seacocks only when necessary.

ENGINE EXHAUST SYSTEM

The engine exhaust system vents engine exhaust gases away from the boat. Inboard engines may use mufflers and/or seawater to cool part of the exhaust system. Do not make changes or modifications to the exhaust system. See the *Engine Operator's Manual* for engine exhaust system and service information.

ENGINE LUBRICATION SYSTEM

Inboard engines, like automotive engines, use a sump system where the engine oil is contained in the engine. See the *Engine Operator's Manual* for engine oil recommendations and service information.

ELECTRICAL SYSTEM

Boats may be equipped with one or two types of electrical systems: Direct Current (DC) and Alternating Current (AC).

Most boats use a battery-powered direct current (DC) system; some boats also use a generator or shore-powered alternating current (AC) system. Most systems have a main load panel which serves as the main distribution panel.

DC SYSTEM

 **WARNING** *Fire/Explosion Hazard: Always use caution when operating and maintaining the DC electrical system. Fire or explosion may result from improper use of the DC electrical system.*

Most boats use a 12-volt common negative ground DC system. DC systems are usually the primary electric supply for lights, pumps, blowers, engine starting, etc.

Boats require at least one battery per engine. Multiple-battery systems consist of a cranking battery for each engine and additional batteries that supply auxiliary power to DC electrical circuits.

Battery switches control battery power distribution and disconnect the batteries from the boat's electrical system. The engine's charging system charges batteries connected to the charging system when the engines are running.

Battery isolators prevent accessory loads and other batteries from depleting power from charged batteries. Isolators also allow the engine's charging system to isolate the alternator charging output and distribute the charge among all batteries according to individual need.

Section 9

The main DC control panel may feature a voltmeter, battery test switch, fuses, circuit breakers and a master breaker switch.

⚠ WARNING *Fire Hazard: Never reset a breaker that has been automatically tripped or replace a fuse that has blown without first identifying and correcting the cause of the problem. A fire could result.*

⚠ WARNING *Fire Hazard: DO NOT exceed the recommended fuse sizes or bypass the fuse safeguard. Always install the proper (type and rating) fuses whenever replacing or changing fuses.*

BATTERIES

Centurion Boats come standard with dual batteries along with a battery switch that allows for “OFF/ON/COMBINE” functions. “ON” should be used for normal operation of the boat. “COMBINE” should only be used to jump start the boat in emergency situations. If listening to the stereo without the motor running make sure the battery switch is only in the “ON” position. This way if the battery dies, you can still flip the battery switch to “COMBINE” to start the motor. The battery switch is located under the Observer seat.

Dual Battery Setup

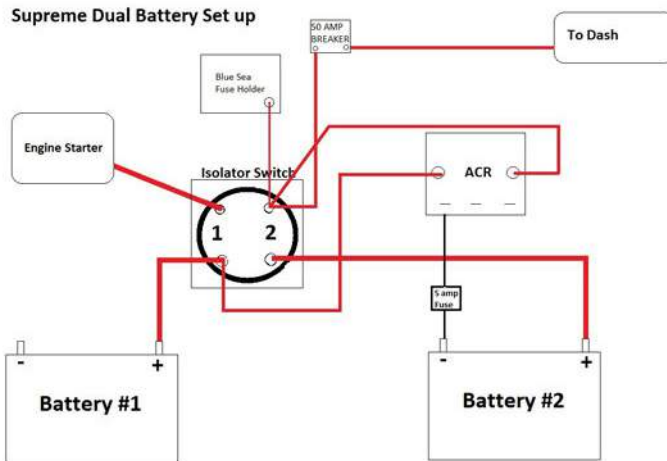

BILGE PUMP SYSTEM

The Federal Water Pollution Control Act prohibits the discharge of oil or oily waste into the water. Violators can be fined \$5,000.

Water will enter a boat for a number of reasons, including heavy seas, strong storms and long periods of rain. The bilge area is usually the deepest part of the hull and where the water settles. The bilge pump moves water from the bilge area through hoses and empties it through an opening in the hull.

An automatic bilge pump system features automatic activation of the bilge pump by use of a float switch in the bilge area that, when activated, turns the pump on to allow water to be pumped out. The bilge pump can also be operated manually by a switch at the helm.

NOTICE

Do not allow the bilge pump to operate after all the water has been cleared from the bilge area; damage to the pump will occur if you operate it without water. Periodically check the bilge area and float switch and remove any debris that may clog the pump or render the float switch inoperative.

PROPELLER STRUT

The propeller shaft is supported on the outside of the hull by a strut. The strut integrates a composite bearing supporting and allows the propeller shaft to rotate in the strut.

NOTICE

The propeller shaft strut bearing is lubricated by water. Do not shift the transmission and run the propeller out of the water, even if water is supplied to the engine's cooling system. Damage to the shaft and bearing can occur.

Section 9

Typical Propeller and Strut



CNTRN-0021C-A

PROPELLERS

The following basic information may not apply to all forms of propulsion. See the *Engine Operator's Manual* for information on propellers for the boat. Consult the boat dealer for assistance when replacing or servicing propellers.

The propeller converts the engine's power into the thrust needed to propel the boat. Care and selection of your propeller is very important for proper boat operation. Propeller size is usually identified by three numbers, such as 13 x 16 x 1-1/8, and a material identification, such as brass, aluminum or stainless steel. In the number sequence, the first number is the diameter of the propeller in inches and the second is the pitch in inches and the third number is the diameter of the propeller shaft.

Pitch is the angle of the blades expressed in the theoretical distance a propeller travels in each revolution. In the above example, the pitch is 16, which means that each revolution of the propeller pushes the boat 16 inches (406 mm) through the water.

It is recommended that the boat be removed from the water for propeller replacement,

as the propeller is not easily accessible while the boat is in the water. A special puller and tools are required to remove the propeller in most applications.

Always consult your local marina or certified marine technician for assistance when replacing or servicing propellers.

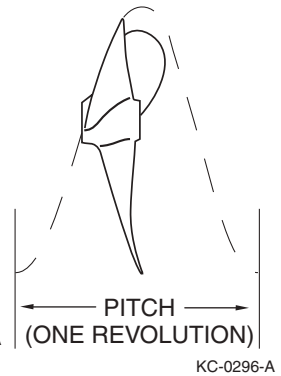
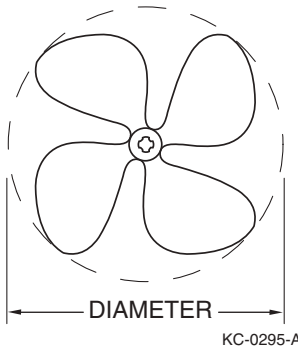

PROPELLER SELECTION AND REPLACEMENT GUIDELINES

There are many different propeller designs for specific operating characteristics. Always consult a certified marine technician when servicing or replacing your propeller.

It is highly recommended that you arrange for your dealer to perform any propeller service, removal or installation procedures.

To prevent personal injury and/or equipment damage, follow these guidelines before installing or removing the propeller:

- Remove the boat from the water into a position where the propeller is accessible.
- Position the shift control in NEUTRAL.
- Position the battery switch to the OFF position or remove the negative battery cable from the engine starting battery to ensure the engine cannot accidentally start.
- Place a wood block between the boat hull and the propeller to hold the propeller in place while removing the propeller nut.

 **WARNING** *Never use your hand to hold the propeller when removing the propeller nut.*

- When removing the propeller, use a propeller puller (consult your dealer) to remove the propeller following the puller manufacturer's instructions.
- When installing the propeller, verify the propeller is tight on the shaft and the propeller nut is torqued to the correct specification (consult your dealer).

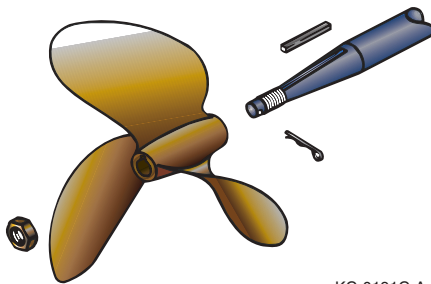

KC-0191C-A

ENGINE COMPARTMENT VENTILATION SYSTEM

Ventilation or blower systems are designed to remove explosive vapors that accumulate in the bilge area and engine compartment. Proper ventilation is extremely important to personal safety while boating.

Powered ventilation systems consist of one or more sealed fans that replace vapors with fresh air through intake and exhaust vents. Always operate the blower for at least four minutes before you start the engine. You should also operate the blower continuously when at idle and during slow-speed operation.

Natural ventilation systems also have intake and exhaust vents; as the boat moves, air is forced into the intake vent and escapes through the exhaust vents.

The engine compartment cover is a structural part of the boat and acts as a machinery guard. The engine cover must be in place and closed whenever the engine is running. DO NOT operate your boat with the cover open or with the engine exposed.

 **WARNING** *Contact with moving parts can entangle, cut and can cause death or serious injury. Never make contact with any running machinery moving parts, such as the engine or propeller.*

COCKPIT HEATER SYSTEM (OPTIONAL)

A marine heater uses the heated engine coolant to produce forced air heat through a ducted location in the boat or through a snorkel-type tube. Heated engine coolant is circulated through a heater core and an electric blower fan moves air over the heater core, transferring heat from the heater core to the ducted area air in the boat or on the windshield. Where applicable, the snorkel tube can be moved anywhere within its reach to provide an isolated heat duct. To turn the heater blower fan on or off, select heater settings in the dash system.

See the *Marine Heater Operator's Manual* for further information.

CENTURION SHIFT DRIVER ASSIST (OPTIONAL)

This thruster system is designed to make driving your Centurion Boat easier at high or low speeds. At the flip of a switch on the throttle shifter, you can make tighter and more precise turns when trailering your boat or navigating the docks at a marina. You can also utilize this system to make faster and sharper turns to recover a fallen rider in the water.

This Page Intentionally Left Blank

CENTURION BOATS

Section 10

OPERATING THE BOAT

Before operating the boat, review *Safety in Section 3*.

 **WARNING** *Control Hazard: Certain actions can cause you to lose control of the boat:*

- *When accelerating the boat in the forward direction, the bow can rise and restrict visibility. Observe for obstacles and people before accelerating.*
- *The rotational thrust of the propeller under rapid acceleration can create high steering torque and rapidly change the direction of steering, causing loss of control.*
- *Do not trim the engine out too far or the boat may begin to “porpoise” (bounce up and down). Porpoising reduces control and visibility.*
- *Improper use of trim tabs or moving them down at high speeds can cause loss of control.*
- *If you lose control of the boat, pull back on the throttle and trim in at the same time.*

BEFORE GETTING UNDERWAY

SAFETY EQUIPMENT

Federal and local laws require certain safety equipment to be on board at all times. Responsible boaters carry additional equipment in case of emergency.

FILING A FLOAT PLAN

Complete a float plan before departure and leave it with a reliable person who is aware of your intentions while on the water. In case of emergency or if you do not return as planned, this information can be helpful to the USCG or others in rescuing or contacting you. There are several float plan apps that make it easy to fill out and email the plan. For more information on float plans or to download a float plan form, go to:

<https://www.floatplancentral.cgaux.org>

PRE-DEPARTURE SAFETY CHECKLIST

The following checks are essential to safe boating and must be performed before starting the engine or getting underway. Perform these checks every time you operate the boat so they become routine.

Never launch the boat or leave the safety of the dock if any problem is found during the pre-departure safety check. A problem could lead to an accident during the outing, causing severe injury or death. Have any problems corrected before proceeding:

- Check the current and forecasted weather reports, as well as wind and water conditions.
- Make sure the operator is qualified to operate the boat and does not use drugs or alcohol while at the helm.
- Make sure all required safety equipment is on board.
- Make all passengers aware of safety procedures.
- File a float plan.
- Have all required documents on board.
- Have all maps or navigational charts for the intended destination on board.
- Be sure all passengers are properly seated.
- Be sure the boat is not overloaded.
- Check the engine cut-off switch lanyard for proper installation and operation.
- Be sure the fire extinguisher is fully charged.
- Check bilge drain plugs for proper installation.
- Be sure all water has been pumped from the bilge area.
- Have plenty of emergency food and water on board.
- Check the bilge blower (if equipped) for proper operation, and be sure no fumes are present in the bilge area.
- Be sure all required equipment is on board (mooring lines, anchor lines, tool kit, etc.).
- Be sure you have enough fuel for the return trip.
- Check all compartments for fuel fumes.

- Check that no fuel, oil or water is leaking or has leaked into the bilge compartment.
- Check all hoses and connections for leakage and damage.
- Check the hull and propeller for damage.
- Check the engine cooling water intake pickup for blockage.
- Check that batteries are fully charged and the battery terminals are clean and tight.
- Check the electrical systems and navigation lights for proper operation.
- Be sure no person or obstacle is near the propeller.
- Check that the throttle/shift control is in the NEUTRAL position.
- Check the steering system for proper operation.
- Inspect the steering, throttle and shift cables for kinks, wear and interference with other components.
- Check that all required maintenance has been performed.

Check the following engine related items:

- Check that no fuel, oil or water is leaking or has leaked into the bilge compartment.
- Check all hoses and connections for leakage and damage.
- Check the hull and propeller for damage.
- Check the V-Drive fluid level.
- Check the engine belts for looseness or damage.
- Inspect the exhaust system for leaks.
- Inspect the propeller shaft seal for excessive water entry.
- Inspect the drivetrain for loose or missing hardware.

BOARDING

Helpful guidelines when boarding a boat:

- Always step, rather than jump, into a boat.
- Avoid stepping on fiberglass or other potentially slippery surfaces.
- Always board one person at a time.
- Never board while carrying gear. Set the gear on the dock, board the boat and then pick up the gear.
- Never use the engine unit as a boarding ramp.
- It is courteous to always ask for permission to board so the owner/operator is aware of your presence on the boat.
- Always face the boat when boarding/re-boarding using a ladder.

See the *Using the Platform/Boarding Ladder* section of this manual for re-boarding the boat from the water.

USING THE BOARDING PLATFORM / LADDER

Unassisted reboarding using a swim platform is a crucial safety feature for boaters. Our boats are often equipped with swim platforms and boarding ladders (optional) that comply with the American Boat and Yacht Council (ABYC) Standard H-41.

Here are some steps to help you do it safely and efficiently:

- 1. Locate the Swim Platform:** Swim platforms are usually at the stern (back) of the boat. Make sure you know where it is before you enter the water.
- 2. Use the Handle:** our boats have a handle near the swim platform. Use this handle to steady yourself as you approach the platform.
- 3. Position Yourself:** Position yourself so that you are facing the swim platform. This will make it easier to pull yourself up.
- 4. Kick and Pull:** Use your legs to kick and give yourself a boost while pulling yourself up with the handle. Try to get your knees onto the platform first.
- 5. Climb Up:** Once your knees are on the platform, use your arms to pull the rest of your body up. Be careful and take your time to avoid slipping.
- 6. Ask for Help:** If you're having trouble, don't hesitate to ask someone on the boat to give you a hand.

Boats equipped with a transom-mounted boarding platform have a few extra precautions to be aware of:

- When re-boarding boat from water, be sure that boat engine is off. To board, carefully pull oneself onto boarding platform and enter cockpit of boat from rear transom hatch.
- NEVER allow anyone on the boarding platform or in the water near the platform while the engine is running.
- NEVER attempt to surf on or off the platform while the engine is running.
- NEVER "Platform Drag" or touch the boarding platform from the water while the engine is running.
- NEVER exceed the weight capacity of the boarding platform; all boarding platforms have weight limits. If there is no capacity decal, ask your dealer.
- Boarding platforms may be wet and slippery; advise passengers to use caution and any available hand-holds when using the platform. Never apply wax to the working deck portion of the platform.
- If the boarding platform is equipped with a ladder, be sure the ladder is fully retracted and secured before operating the boat.
- If the boarding platform is removable, be sure it is properly secured before operating the boat.

BOAT LOADING

The safety and performance of the boat depends on load, weight and the distribution of each.

The person/load capacity is determined by the USCG. A capacity plate is usually located within clear visibility of the boat operator or helm area. The capacity plate indicates limits for loading the boat, which are enforceable by law.

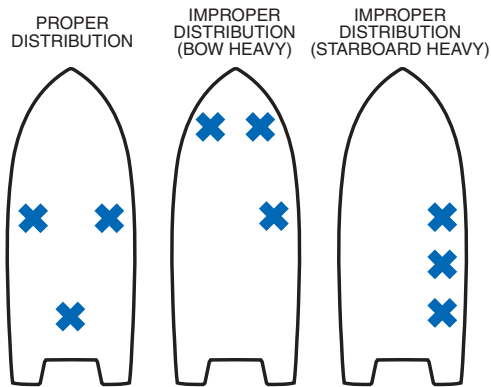

KC-0333-A



WARNING

Sinking Hazard: NEVER exceed the USCG certified maximum capacities under any circumstances. Exceeding the limitations stated on the capacity plate can cause the boat to sink or the passengers and/or operator to drown, resulting in death or serious injury.

- Board passengers one at a time and distribute them equally to maintain equal buoyancy of the boat.
- Distribute weight equally from port to starboard and fore to aft. The shifting of weight may be required when underway to maintain an efficient trim position for optimum performance.
- Stow and secure all loose gear in stowage areas to prevent load shifting.
- Do not stow gear on top of safety equipment; safety equipment must be quickly accessible.
- In adverse weather, reduce the load in the boat. Person and load capacity ratings are calculated for normal boating conditions.

FUELING

FUEL MANAGEMENT

Use the “one-third” rule for fuel management. Use one-third of the fuel to reach your destination, one-third to return and one-third as reserve fuel.

FUEL SUPPLIERS

Refuel only at approved suppliers such as marina fuel docks or automotive fuel service stations. Approved suppliers have safeguards in place to lessen the likelihood of static discharge. Use only containers and funnels approved for use with the fuel type. See the *Before Refueling* section of this manual for additional information.

STATIC ELECTRICITY AND THE FUEL SYSTEM

The boat’s built-in fuel tank has a bonding system that protects it from creating and discharging static electricity. The boat must be in contact with the water or on its trailer when refueling to complete the bonding system.

If the bonding system is not complete, an electrostatic spark may occur.

 **WARNING** *Fire/Explosion Hazard: An electrostatic spark can ignite fuel vapors, causing a fire and/or explosion.*

Use extreme caution when filling the fuel system. In addition:

- Remove portable fuel tanks from the boat and place them on the ground to fill. The fuel tank must be properly grounded before refueling. If keeping portable tanks on board, store them only in a ventilated compartment. Never store them in an engine compartment or near heat/flame-producing accessories.
- Do not refuel a built-in fuel tank if the boat is suspended from a sling or another type of boat lift system. Suspending the boat from the water interrupts its bonding system. Using a portable fuel tank to refuel the boat while it is suspended may cause an electrostatic spark.

FUEL (GASOLINE)

Fuel for marine gasoline-only engines must be carefully selected to avoid fines and possible catastrophic engine damage not covered under warranty. It is illegal for any person to tamper with emissions control devices such as the fuel system, and it is also illegal for any person to mis-fuel a marine gasoline-only engine with a blend of more than 10% ethanol.



While it is always preferable to use fuel that does not contain ethanol (usually labeled as “marine” or “recreational”), most marine engines are designed to tolerate E10 (10% maximum ethanol) fuel as long as the fuel meets the engine manufacturer’s octane requirements. When using fuel containing ethanol, buy fuel in



smaller quantities that will be consumed during the boating session with a 10% reserve. Fuel degrades quickly and the engine operates better on fresh fuel. Use marine fuel stabilizer to treat and reduce degradation of any remaining fuel.

Fuels that contain bio-isobutanol at any percentage are safe to use in marine products and have none of the limitations of ethanol biofuel additives.

Do not use octane boosters or other fuel additives except marine certified fuel stabilizer. Purchase fuel from a quality supplier selling high volumes to ensure the fuel is fresh. For more information go to: www.toptiergas.com/licensed-brands/

NOTICE

Fuels that are blended to contain more than 10% ethanol may damage the engine, oil system or fuel system and should not be used in marine engines. Fuels that contain more than 10% ethanol can corrode metal parts, deteriorate rubber and plastic, or weaken gaskets. Damages caused by the use of fuels that contain more than 10% ethanol or fuels that do not meet engine manufacturer octane requirements are not covered by your warranty.

Gasoline Fuel in the U.S. Market

The majority of recreational boats are trailerable and often fueled at automobile gasoline filling stations. In the U.S. market, there are ever-increasing percentages of ethanol blended with gasoline with the most common being 10%. Since there is no standard for labeling gas pumps, it can be confusing to select the proper blend – LOOK BEFORE YOU PUMP!

Section 10

Ethanol blends of more than 10% are tempting to use in your boat because they are cheaper. Ethanol blends of more than 10% are NOT meant for ANY outdoor power equipment and their illegal use will not only deteriorate rubber and plastic, causing an environmental hazard, but will cause permanent DAMAGE to the engine that is not covered by the Warranty – DO NOT BUY GAS BY PRICE!

	CONTAINS NO ETHANOL	UP TO 10% ETHANOL	UP TO 15% ETHANOL	UP TO 30% ETHANOL	UP TO 50% ETHANOL	UP TO 85% ETHANOL
OK for Boat Engines	Yes	Yes	No	No	No	No
OK for Long-Term* Storage	Yes	No	No	No	No	No
Covered by Engine Warranty	Yes	Yes	No	No	No	No
Illegal to Use in Boat Engines	No	No	Yes	Yes	Yes	Yes
Price	Most Expensive	About 5% less	About 10% less	About 20% less	About 30% less	Least Expensive

* 3 – 6 months with marine-grade fuel stabilizer *added immediately*

** Not more than one month with marine-grade fuel stabilizer *added immediately*

BEFORE REFUELING

 **WARNING** *Fire/Explosion Hazard: Gasoline is extremely flammable and highly explosive under certain conditions. Be sure to check the fuel hoses and connectors for leaking and deterioration before fueling and on a monthly basis.*

- Refuel the tanks only in a well-lighted area.
- Know where the fire extinguishers are.
- Stop all engines, motors, blowers and appliances before refueling.
- Do not smoke or allow open flames or sparks nearby, within 50 feet (15 meters), of the fueling area.
- If equipped, close all doors, windows, hatches and ports.
- Determine the amount of fuel required to fill the tanks. Fuel expands as the ambient temperature increases; do not overfill the fuel tank. Allow for at least a 6% expansion of fuel when refueling.

FUELING

The fuel fillers are located in the aft area on both port and starboard side. The fuel tank is equipped with an antisiphon valve that operates automatically to prevent fuel from draining from the tank in the event of a leak in the fuel system.

Gasoline fumes are heavier than air and will sink to the lowest part of your boat, such as the bilge. Always evacuate fumes with the bilge blower before attempting to start the engine.

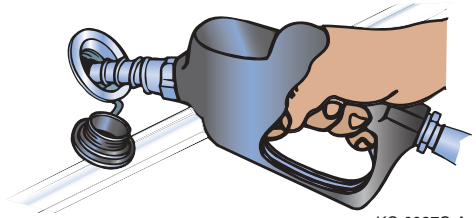

KC-0027C-A

NOTICE

To prevent unwarranted engine damage, refer to the Engine Operator's Manual for recommended fuel and oil specifications.



CAUTION

The fuel tank may be under pressure. Remove fuel filler cap slowly to release any pressure.

REFUELING BUILT-IN FUEL TANKS

When refilling a permanent fuel tank from a land-based fuel nozzle with the boat out of the water, maintain contact between the fuel nozzle and the fill pipe at all times, before and during refueling, to prevent an electrostatic spark. If it's necessary to use a funnel, use a metal funnel. Do not use a plastic funnel. Do not fill built-in tanks from unapproved portable containers.

When refilling a permanent fuel tank from an approved portable fuel container with the boat in the water, a plastic funnel may be used.

NOTICE

If the boat is unlikely to be used for two weeks or more, and you are using an ethanol-blended fuel, fill only the amount of fuel you need plus 10% as a safety factor. Unused ethanol-blended fuel deteriorates quickly.

AFTER REFUELING

- Close the fuel fill cap thoroughly.
- Wipe up any spilled fuel completely. Dispose of rags properly onshore.
- Open all doors, windows, hatches and ports to ventilate all spaces. Check for fuel vapors before starting any engines or appliances.
- If equipped, operate the blower for a minimum of four minutes before starting the engine.

GETTING UNDERWAY

The following basic boat maneuvering and operation principles do not cover all conditions or situations you may encounter during operation. It is important for you and anyone else operating the boat to have certified instruction before operating the boat.

Always advise all passengers on board of your steering, stopping and accelerating intentions. Brief passengers on:

- Obeying captain's orders
- Safety equipment location and operation
- Basic boat operation
- Radio operation
- Re-boarding procedure
- Man overboard procedure
- Emergency procedure
- Hazardous weather procedure
- Docking procedure
- Fueling procedure

STARTING

Secure the boat to the dock before starting the engine. See *Section 8 - Helm and Controls* for operation and location information.

1. Open the seacock in the engine compartment by moving the lever so it is parallel to the valve body.
2. Rotate battery switch to the ON position.
3. Attach the hook of the emergency kill switch lanyard to your life jacket or belt loop. Attach the other end of the lanyard to the emergency kill switch on the power switch panel.
4. Check that the throttle/shift control lever is in the NEUTRAL position.
5. **For Ri Series Boats:** Insert key if used and turn the power switch to the ON position.
For Fe Series Boats: Insert key and turn clockwise to turn the power switch to the ON position.
6. Press Blower button to switch blower ON. Allow blower to run for at least 4 minutes or 5 minutes after fueling

 **WARNING** *Explosion Hazard: Gasoline vapors can explode. Before starting the engine, operate the blower for at least 4 minutes and check the engine compartment for gasoline leaks and vapors. Do not start engine if you smell fuel. Always run the blower below cruising speed.*

7. Check that all passengers are properly seated and are familiar with the location and operation of safety equipment.
8. **For Ri Series Boats:** After 4-5 minutes of blower operation, press Ignition button to turn on the side-by-side screen.
For Fe Series Boats: After 4-5 minutes of blower operation, turn the key clockwise until engine starts. Then allow the key to fall into running position.
9. **For Ri Series Boats:** Press and hold the Start button until the engine starts, and then release the button.
10. Allow the engine to warm up as noted in the Engine Operator's Manual.

STEERING

 **WARNING** *Control Hazard: If the engine is shut off (no thrust), you will have no steering control, and the boat's momentum will cause it to move forward even though the engine has stopped. Even at low engine speeds where thrust is reduced, a loss of steering control can occur.*

Steering a boat is very different from steering an automobile. Steering and maneuvering a boat is far more difficult and requires time and practice to master.

When steering a boat, it is important to understand the causes and effects of turning. Since both thrust and steering are at the stern of the boat, the stern will push away from the direction the steering wheel (helm) or tiller arm is turned. The boat seems to skid across the water while turning, which feels very different from an automobile making a turn.

Steering in reverse has its own challenges. Practice forward and reverse steering to gain comfort and to feel in control of the boat in any steering situation. Due to the rotational thrust of the propeller, the boat may pull to starboard when backing up at slow speeds. This is normal and can be compensated for when backing up.

Be prepared for wind and current while steering the boat. Steering in wind or water currents is difficult and requires skill to be able to anticipate and compensate for these effects.

Section 10

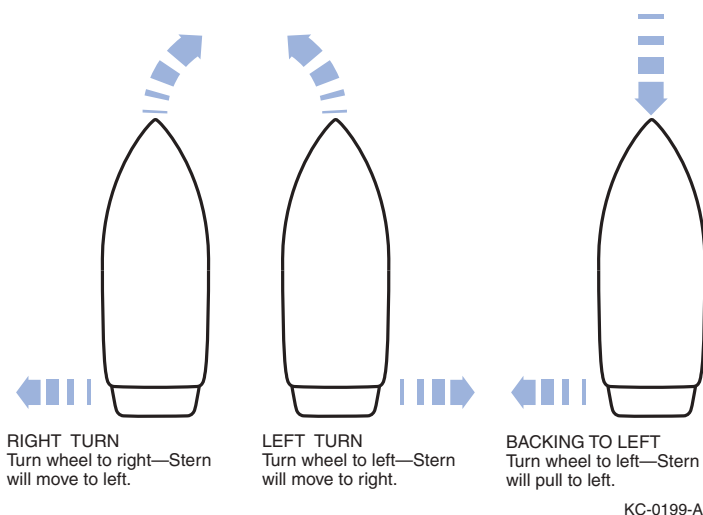

Rotational thrust of the propeller is an aspect most single propeller-driven boats share and needs to be compensated for at slow speeds. During rotational thrust, torque is transmitted to the helm and may cause the boat to drift either port or starboard when moving forward at a slow speed. Rotational thrust usually goes unnoticed at high speeds. While moving forward at a slow speed, constant helm corrections are usually necessary to maintain a straight course.

Some boats may be equipped with an adjustable rudder, which helps reduce steering torque felt at the helm by counteracting the rotational thrust of the propeller at slow speeds.

SHIFTING

The following information is a basic guideline only and may not apply to the specific shift control. See the *Engine Operator's Manual* or control manufacturer's information for the shift control operation, adjustment and maintenance.

- Most side-mounted throttle and shift controls have a neutral detent lock that must be released before shifting from NEUTRAL.
- Always use a brisk and decisive movement when shifting into or out of gear.
- Always pause in NEUTRAL before shifting from FORWARD to REVERSE, or REVERSE to FORWARD. Most throttle and shift controls have a detent position for NEUTRAL, FORWARD and REVERSE engagement positions. These detent positions are important; when shifting into and out of gear, always pause in these positions.
- Never shift into REVERSE while your boat is in FORWARD gear when traveling at any speed above idle.
- Always keep the shift control clean and clear of obstructions.

STOPPING

Reverse thrust is commonly used to slow and stop a boat. The amount of reverse thrust needed to stop will vary due to boat design, load and speed.

 **WARNING** *Control Hazard: Always reduce engine speed to idle and pause in NEUTRAL before shifting from FORWARD to REVERSE or REVERSE to FORWARD. Abrupt stopping and steering loss can occur if the propulsion unit is shifted quickly from FORWARD to REVERSE or REVERSE to FORWARD. Never shift into REVERSE at planing or high forward speeds.*

A boat does not have brakes. Controlling the boat to a stop and while stopped are important skills that must be learned. Reverse thrust is commonly used to slow and stop a boat. The continued momentum of a boat will vary according to the boat design, load and speed. You must also consider and learn to compensate for the effects of wind and current. Stopping in wind or water currents is difficult and requires skill to be able to anticipate and compensate for these effects.

- To stop or slow forward motion, always gradually return the throttle(s) to the slow IDLE position, pause and shift into NEUTRAL, then pause and shift into REVERSE.

 **WARNING** *Control Hazard: Gradually return the throttle(s) to the slow IDLE position. Failure to do so can cause loss of boat control and engine propulsion system damage.*

- If the boat has been driven for a long period of time at high speed, allow the engine a two- to three-minute cool-down period at low idle in NEUTRAL.
- Turn the ignition key to the OFF position.

NOTICE *Never pull the lanyard from the engine emergency stop switch for normal shutdown. Doing so may impair your ability to restart the engine quickly.*

- Avoid collisions; at high speeds the boat will require more time and distance to stop or slow.

Passive Hydrolock

Passive hydrolock occurs when water is siphoned through the boat's exhaust system, enters a cylinder in the engine and results in a non-start. This is possible on any marine vessel powered by a combustible engine with exhaust risers that sit below the waterline. Once the boat is ran and the engine heated, if it is allowed to cool for over 5-10 minutes without emptying the ballast or while the exhaust risers remain below the waterline, the potential for passive hydrolock exists. When the exhaust risers are allowed to sit below the waterline during the engine cooling process, water can siphon through the exhaust system into an open cylinder, causing a non-start.

Section 10

If your ballast is full when you shut down for over 5-10 minutes to swim and play, make sure you empty your rear surf tanks and rear plug n' play bags. This simple task will prevent your exhaust risers from sitting below the waterline. If you are merely swapping out riders it is not necessary to drain your tanks.

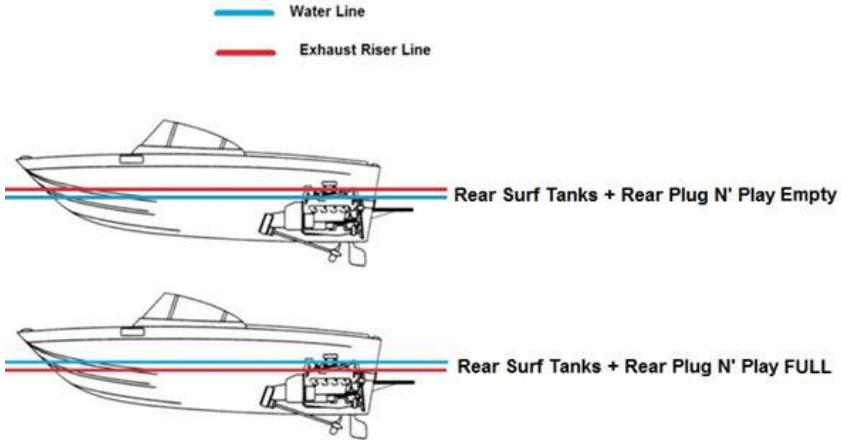

ACCELERATING AND RUNNING UNDERWAY

You must understand the boat's equipment and controls in order to drive and control the boat in a forward direction at all speeds and in all conditions. Learning to drive and control the boat can be challenging; take this matter seriously and spend plenty of time practicing.

The phrase "on plane" is commonly used when referring to the running angle of a boat in forward motion. When a boat is "on plane," its hull is usually running level or almost level with the water's surface, which is considered level. The level "plane" of the water's surface is the most efficient angle to run in. This basically means that the boat is running on top of the water and not plowing through it.

Factors to consider when accelerating a boat forward and running at the most efficient planing angle are:

- Boat design
- Hull type and condition
- Boat load and distribution of weight
- Engine capability and condition
- Propeller type, size and condition
- Power trim equipment and condition (if equipped)

Because all boats are different and vary in design, purpose and load, planing angles and characteristics will vary among all boats. Become familiar with the boat's characteristics and obtain qualified assistance.

The following guidelines provide a basic understanding of forward acceleration and operating on plane while underway:

- Always look in front of and around you before proceeding. Avoid collisions before accelerating; be aware and stay clear of people and obstacles in the water.
- Always advise all passengers on board of your intention to accelerate and get underway.
- Stow and fasten all loose gear.
- Make sure the engine cut-off switch lanyard is connected to the operator.
- If equipped, adjust the boat trim tabs up or to a neutral position with the hull.
- Shift from NEUTRAL into FORWARD detent idle position.
- Adjust steering to the direction of travel.
- Using a controlled and constant motion, move the throttle control forward.



WARNING *Control Hazard: When accelerating forward, the bow can rise and restrict visibility. Never remove your hand from the steering wheel. The rotational thrust of the propeller under rapid acceleration can create high steering torque and rapidly change the direction of steering, causing loss of control.*

- As the boat begins to move, the bow will rise and the boat will tend to plow through the water. As acceleration increases, the boat will begin to plane or level out within a few seconds. If it will not plane to a near-level position and has sufficient horsepower, slowly reduce the throttle back to the FORWARD detent idle position. Recheck the load distribution and trim equipment position to determine the cause.
- Once the boat is on plane, the steering torque will diminish; however, never remove your hands from the helm while underway. While running at a planed position, you will notice greater throttle response and steering control as you continue to accelerate or achieve the most comfortable and safe speed for the conditions. You can achieve better performance, control and running efficiency using the engine's power trim and the boat's trim tabs, if equipped.
- Be aware of the wake you create and anticipate the effect it will have on others. During acceleration, deceleration and at speeds other than on plane, a heavy wake is usually created. You are responsible for the boat's wake and any damage or injury it causes.

Section 10

- Obey no-wake areas and speed-controlled areas.
- Stay clear of or at a safe distance from other boats.
- Avoid collisions; at high speeds the boat will require more time and distance to stop or slow.

CHECKS DURING AND AFTER OPERATION

- Check gauges frequently for signs of abnormal conditions.
- Check that controls operate smoothly.
- Check for excessive vibration.

DOCKING

Practice leaving and approaching the dock to become familiar with the procedures.

Helpful guidelines when departing from the dock:

- Make sure you have sufficient space to maneuver the boat away from the dock, other boats and any other obstacles that may hinder your departure.
- Always allow sufficient clearance to the stern for the engine to clear any obstructions.
- Be aware of other boat traffic, wind and water conditions before departing.
- Make sure the engine is started and you have boat movement under control before casting off any mooring lines.
- Always proceed slowly when departing from a dock.

Helpful guidelines when docking:

- Make sure you have sufficient space to maneuver your boat around the dock, other boats and any other obstacles that may hinder your approach.
- Be aware of other boat traffic, wind and water conditions on your approach.
- Approach from a direction against the wind or current.
- When possible, approach slowly from a 45-degree angle and then steer parallel to the dock.
- Have fenders, dock lines and assistance ready.

 **WARNING** *Personal Injury Hazard: Never use your hand, arm or any other part of your body to attempt to keep the boat from hitting the dock. The boat could push against the dock, causing severe injury.*

- If possible, throw a mooring line to a person on the dock and have that person secure the bow. With the bow secure, swing the stern in with the engine or pull it in using a boat hook or the stern line.
- Tie off the bow and then the stern.
- Use bow and stern dock lines, as well as spring lines, for additional security.
- Use fenders to protect the boat from damage.
- Never attach a dock line to a point or part of the boat that is not designed to withstand the stress and the weight of the boat.
- If planning on docking the boat for a long period of time, use chafing protectors on the lines to protect the boat's finish.
- Leave some slack in the lines to allow for wave movement or tidal action if applicable.

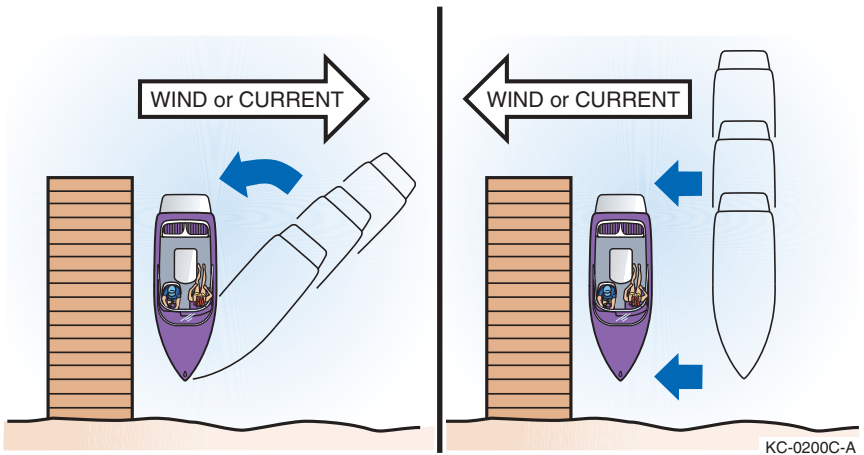

MOORING

NOTICE

It is not recommended to leave your boat in the water for extended periods of time. Extended mooring may cause hull surfaces to discolor and/or blister. Damage caused from this type of exposure is not covered under the Centurion Boats warranty. If extended mooring is necessary, consider using a high quality bottom paint for additional protection.

Because mooring configurations vary, consult with other experienced boaters or the boat dealer for recommendations on properly mooring the boat. Always moor the boat securely to prevent personal injury or property damage.

Helpful guidelines when mooring:

- Each mooring line must be of the appropriate strength, material and type to safely secure your boat when moored.
- Each mooring line must be longer than the length of the boat.
- Use bow and stern mooring lines, as well as spring lines, for additional security.
- Use fenders to protect the boat from damage.
- When possible, tie up with the bow facing into the wind or current.
- Never attach a mooring line to a point or part of your boat that is not designed to withstand the stress and the weight of the boat.
- Only use the bow eye, stern eyes and other cleats or attachment points that have been approved for mooring. Designated strong points should be used whenever possible.
- If you plan on mooring the boat for a long period of time, use chafing protectors on lines to protect the boat's finish.
- Leave some slack in the lines to allow for wave movement or tidal action if applicable.

ANCHORS AND ANCHORING

Anchors are available for various applications and come in many sizes, types and shapes. Boat weight and size are primary factors in choosing an anchor. When selecting an anchor, consult other qualified boaters familiar with the waters or the boat dealer.

Anchor line is constructed from various materials and is available in many diameters and types. The anchor rode for recreational boats consists of the anchor line connected to a length of chain attached to the anchor. Consult with the boat dealer for a recommendation on appropriate lines for the boat anchor and application.

For most applications, anchor line length should be at least six to seven times longer than the depth of the water in which you are anchoring. Always have plenty of additional anchor line on board. If anchoring in tidal waters, consider a rode chain about the length of the boat and increase the total anchor line length to ten times the depth of the water at low tide.

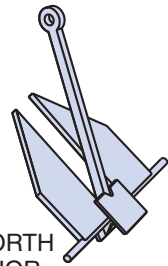

DANFORTH ANCHOR

KC-0042-A

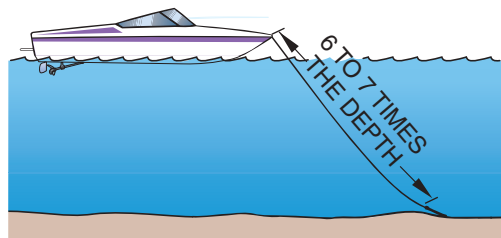

KC-0260C-A



WARNING

Sinking Hazard: ALWAYS anchor from the bow; NEVER anchor from the stern. A small amount of current will make a boat unsteady. A strong current can pull a boat anchored by the stern under the water and keep it there.



WARNING

Collision Hazard: ALWAYS anchor in areas where the boat will not disrupt other boats. Do not anchor in a channel or tie up to any navigation aid. It is dangerous and illegal.

Helpful guidelines when anchoring:

- Make sure the anchor line is tied to the anchor. Tie the other end of the line to the forward cleat or bow eye.
- Head the boat into the wind or current over the spot where you want to lower the anchor.
- Stop the boat before lowering the anchor.
- Slowly lower the anchor until it hits bottom.
- Allow the boat to back away, keeping tension on the line.
- Release at least six to seven times as much line as the depth of the water.
- Secure the anchor line to a designated strong point, typically the bow eye or dedicated anchor bit.
- Firmly pull on the line to make sure the anchor is holding.
- Occasionally check your position against the shoreline. If the anchor is dragging and the boat is drifting, reset the anchor.

Helpful guidelines when weighing (pulling in) the anchor:

- Start the engine(s).
- If necessary, move forward until enough tension is off the anchor line to allow for retrieval of the anchor. Avoid running over the anchor line; retrieve the line as you approach the anchor.
- Once the anchor line is straight up and down, lift the anchor from the bottom.
- If the anchor is stuck, attach the anchor line to the bow cleat so it is tight. The up-and-down motion of the bow from wave action may loosen the anchor from the bottom. If the anchor remains stuck, let out a few more feet of line and attach it to the bow cleat. While keeping tension on the line, slowly maneuver your boat around the anchor to help loosen it. Avoid running over the anchor line.
- Always stow and secure the anchor and line before departing.

LINES AND KNOTS

Mooring, anchor and other nautical lines are constructed from many different types of materials, and are available in many diameters and styles. Consult with your local marine supply store for a recommendation of appropriate lines for the boat and application. Commonly used mooring lines are constructed of a high-quality synthetic material in a double-braided configuration and usually have eye splices on at least one end.

Learn and become familiar with tying and using knots. Knowing how to use knots and lines properly can prevent personal injury and property damage.

Practice tying lines to docks, cleats and anchors, and connecting two lines together. Consult other qualified boaters or the boat dealer, or visit the local bookstore, library or the Internet for information on the proper use of nautical lines and knots. The following illustrations represent a few examples of securing mooring lines.

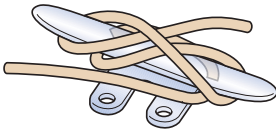

Cleating an open line

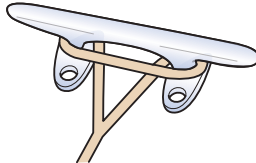

Cleating an eye-spliced line

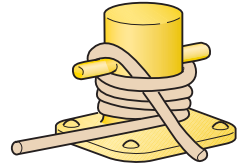

Securing to a dock bitt

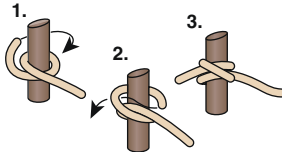

Securing load line
(clove hitch)

A "double half hitch" should always accompany a "clove hitch" on the load line.

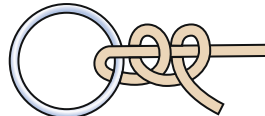

Securing load line
(double half hitch)

KCB-0010

CENTURION BOATS

Section 11

TRAILERING AND LAUNCHING

Before using the trailer, review *Safety in Section 3*.

LEGAL CONSIDERATIONS

The following information is intended as a basic guideline only. See the *Trailer Operator's Manual* for information on operation, adjustments and maintenance.

Before using the trailer, contact your state's Department of Motor Vehicles (and that of other states through which you may be traveling) for information on trailering regulations. Trailer regulations vary widely from state to state, and it is your responsibility to be in compliance with all regulations when trailering the boat.

Regulations include, but are not limited to, trailer registration, licensing, width, height, length, lights, safety chains, tie-downs, hitch type, weight capacity, brakes, spare wheels, vehicle mirrors and gross vehicle weight.

TRAILER CLASSIFICATION

Trailers are separated into four classes based on the Gross Vehicle Weight Rating (GVWR):

TRAILER CLASS	GVWR
Class One	under 2000 lb (907 kg)
Class Two	over 2000 lb (907 kg) and under 3500 lb (1588 kg)
Class Three	over 3500 lb (1588 kg) and under 5000 lb (2268 kg)
Class Four	over 5000 lb (2268 kg)

TRAILER TYPE

Trailers are designed for many applications and can vary in style. To prevent damage to the boat and/or personal injury, always use the appropriate trailer for proper support of the boat. Contact the dealer for more information.

TRAILER GROSS VEHICLE WEIGHT RATING

All trailers must display a Gross Vehicle Weight Rating (GVWR) decal, which shows the load-carrying capacity plus the weight of the trailer. The total weight of the boat (fully loaded with fuel, batteries, water, etc.), engine, gear and trailer must never exceed the GVWR.

TOWING VEHICLE

The towing vehicle must be able to safely pull the full trailer and boat load. Never pull a trailer load that exceeds the vehicle's towing capacity; you risk losing control of the trailer and/or vehicle. Before trailering, always check the *Vehicle Operator's Manual* for maximum towing/trailering load specifications and maximum gross vehicle weight specifications that include the fully loaded trailer.

VEHICLE TOWING HITCH

The towing vehicle must be able to safely pull the full trailer and boat load. The vehicle must have a towing hitch that is capable of safely handling the trailering load and tongue weight of the trailer.

Hitches are designed for many applications and can vary in style. Use professional assistance when selecting the correct hitch and hitch ball for the towing application.

 **WARNING** *Control Hazard: A vehicle hitch that is underrated or improperly installed can lead to loss of control of the trailer and/or vehicle. Never use a hitch that is not rated to pull the maximum weight of the trailering load or that is not rated for the maximum tongue weight that the trailering load applies.*

Hitches are divided into classes that specify the trailer's gross trailer weight and maximum tongue weight for each class.

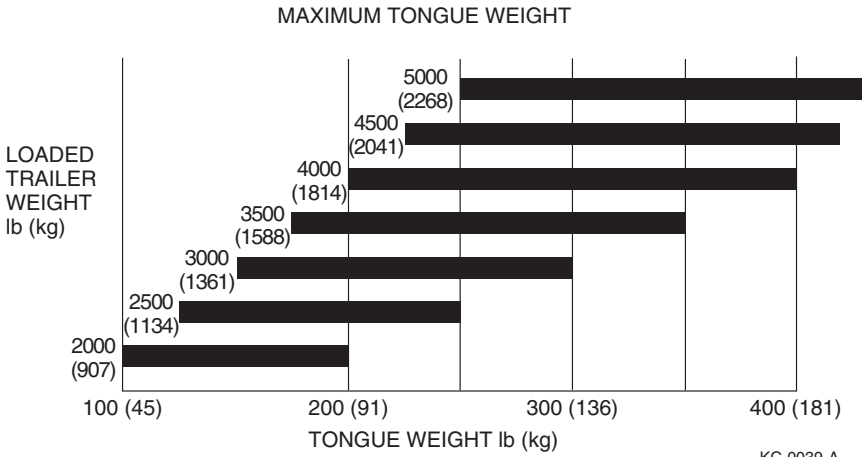

HITCH BALL AND TRAILER COUPLER

Most boat trailers have a coupler that connects to a hitch ball attached to the towing vehicle's hitch. The trailer hitch coupler must always match the size of the hitch ball. The correct hitch ball diameter for the coupler is usually marked on the trailer coupler.

WARNING *Control*
Hazard: *Never use a hitch ball size or rating that does not match the trailer coupler specifications. Using an improper size or rated hitch ball can lead to loss of control of the trailer and/or vehicle.*

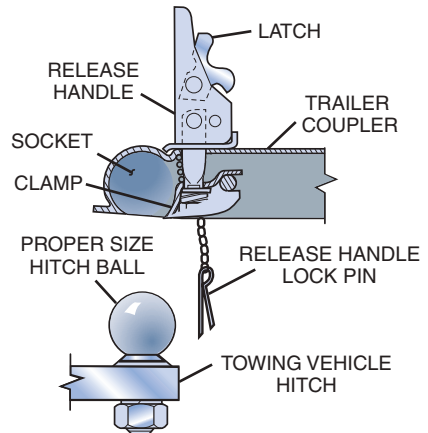

Section 11

Trailer hitch balls are sized and rated for use based on the trailer GVWR:

TRAILER CLASS	GVWR	HITCH BALL DIAMETER SIZE
Class One	under 2000 lb (907 kg)	1-7/8 in. diameter size
Class Two	over 2000 lb (907 kg) and under 3500 lb (1588 kg)	2 in. diameter size
Class Three	over 3500 lb (1588 kg) and under 5000 lb (2268 kg)	2 in. diameter size
Class Four	over 5000 lb (2268 kg)	2-5/16 in. diameter size

SAFETY CHAINS

The boat trailer's safety chains prevent the trailer from completely detaching from the towing vehicle when underway. Connect the chains to the vehicle's hitch or frame and crisscross the chains under the trailer tongue to prevent the tongue from dropping to the road if the trailer separates from the hitch ball. Rig the chains as tight as possible with enough slack to permit full-free turning. Safety chains must be rated at the same or greater weight capacity as the trailer's GVWR.

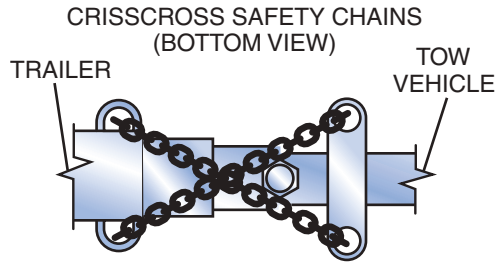

KC-0045C-A

Never allow the chains to drag on the ground when trailering.

Attach the chains properly and securely between the towing vehicle and trailer before trailering.

TRAILER BRAKES

In some states, any trailer with a GVWR of 1500 lb (680 kg) or more is required to have trailer brakes. Check with your state and local authorities for more information.

The three basic types of trailer brakes are electric, hydraulic surge and air-actuated. If the trailer is equipped with brakes, see the *Trailer Operator's Manual* for more information on operation, adjustments and maintenance.

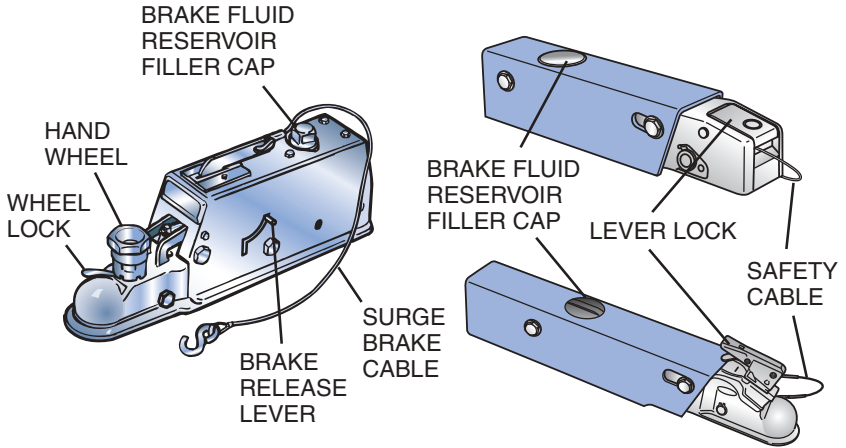

CNTRN-0057-A

5-PIN WIRING CONNECTOR

Some trailers equipped with surge brakes may utilize a 5-pin wiring connector. These trailers use an electric solenoid valve that allows brake fluid to bypass back to the reservoir while in REVERSE. The solenoid is usually connected to the reverse lights on the tow vehicle to ensure the brakes only bypass in REVERSE. The fifth pin is for deactivating the brakes when backing up, and is required to be connected to the vehicle's power when backing up.

TRAILERING GUIDELINES

Follow these guidelines when trailering:

- Before driving, make sure the vehicle maintenance and trailer maintenance are current. This is very important because towing puts additional stress on the tow vehicle.
- Make sure the wheel lug nuts/bolts on the tow vehicle and trailer are tightened to the correct torque.
- Be sure the hitch, coupler, draw bar and other equipment that connect the trailer and the tow vehicle are properly secured and adjusted.
- Make sure all running lights, brake lights, turn signals and hazard lights are working.
- Verify that the brakes on the tow vehicle and trailer are operating correctly.
- Maintain a safe speed as regulated by the trailering laws of the state where you are traveling.
- Check the trailer and vehicle brakes for proper operation and fluid level prior to departure.
- Check the trailer for damage prior to departure.
- Make sure the hitch ball and trailer coupler are the same size and bolts and nuts are tightly secured.
- The coupler must be completely over the ball, and the latching mechanism must be locked down.
- Make sure the safety chains are properly crisscrossed and connected. They should not touch the road but should have enough slack to make turns. If the ball were to break, the trailer would follow in a straight line and prevent the coupler from dragging on the road. Make sure the trailer emergency brake cable or chain is also installed to the tow vehicle frame.
- Ensure the breakaway system lanyard is connected to the tow vehicle and not to the safety chains or ball mount.

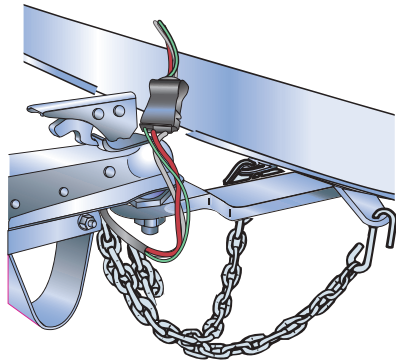

KC-0046C-A

NOTE — Make sure the towing vehicle and trailer are in compliance with all state and local laws. Contact your state motor vehicle bureau for laws governing the towing of trailers.

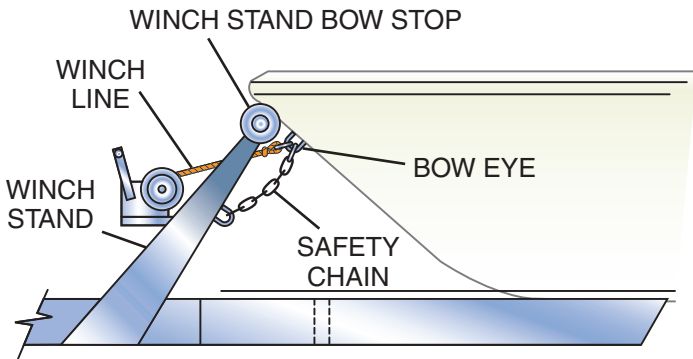

KC-0047C-A

- Once the trailer is secured to the vehicle hitch, stow the trailer jack or lift so that it will not hit the ground.
- Check and correct tire pressure on the tow vehicle and trailer, including the spare tire. Under-inflated tires heat up rapidly and may cause tire damage or failure. The proper tire pressure is listed on the trailer certification plate.
- Check trailer wheel bearings before each trip.
- Secure the stern of the boat to the trailer from the stern eyes.
- Fasten the bow of the boat to the trailer with the bow winch line connected to the bow eye and bow safety chains.
- If travel conditions require, use an additional tie-down strap across the rear of your boat from side to side to further secure the stern.
- Check all strapping material for wear.
- Check that the wiring is properly connected. It should not touch the road but should be loose enough to make turns without disconnecting or damaging the wires.
- Too much or too little tongue weight makes steering difficult and causes the tow vehicle to sway. Put approximately 5% to 10% of boat and trailer weight on the tongue.
- Drive with the vehicle and trailer running lights on.
- Check load distribution to make sure the tow vehicle and trailer are properly balanced front to back and side to side.
- Check that all items are securely fastened on and in the trailer.
- Be sure the trailer jack, tongue support and any attached stabilizers are raised and locked in place.
- Check side-view mirrors and rearview mirrors for good visibility.
- Check routes and restrictions on bridges and tunnels.
- Keep wheel chocks and jack stands on hand.

Section 11

- Side curtains, backdrop, aft curtains, convertible tops and detachable windshields are not designed to stay on boats at highway speeds. Before towing, take down the convertible top, side curtains, back cover and detachable windshield, if equipped.
- Remove any covers that are not designed to stay on boats at highway speeds.
- Carry a spare tire and wheel for both the trailer and the towing vehicle, along with tools to change them.
- See the *Engine Operator's Manual* for engine-related trailering information. Continuous road shocks may fatigue the boat's steering system.
- Tie outboard motors in place so they will not tilt or turn from road shock.
- On extended trips, carry spare wheel bearings, seals and races.
- While traveling, check the wheel hubs every time you stop. If the hub feels abnormally hot, inspect the bearing before continuing your trip.
- Carry a fire extinguisher in the vehicle.
- Turn carefully while towing a trailer; additional space and distance are needed.
- Drive slowly over railroad tracks or rough roads.
- While trailering the boat from lake to lake, boaters may unknowingly introduce a foreign aquatic species from one lake to the next. Thoroughly clean the boat below the waterline, remove all weeds and algae and drain the bilge and livewells before launching it in a new body of water.

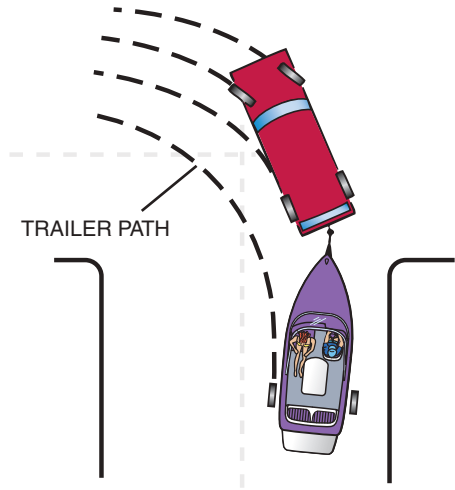

KC-0294C-A

BACKING UP

If you have never towed a trailer before, take time to practice and become comfortable with backing up the boat and trailer. Situations can arise in traffic, or when launching, that will require you to be able to back up the trailer safely.

Follow these guidelines when backing a trailer:

- Back slowly and make small steering adjustments.
- Turn the car wheels in the direction opposite where you want the trailer to go.
- After the trailer begins moving, turn the car to follow it.
- Have a second person assist you with audible and hand signals.

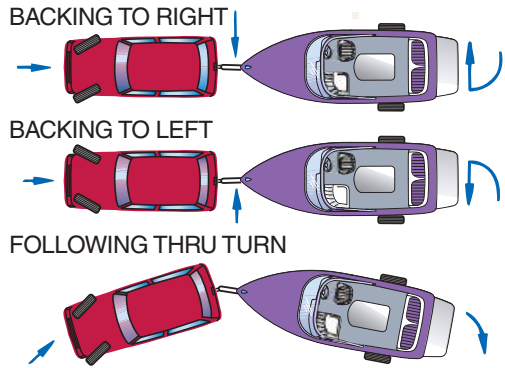

KC-0249C-A

LAUNCHING

Before launching, inspect the launch ramp for any problems that may hinder launching or make launching unsafe. Ramps can be slick and dangerous to drive or walk on, and may have unseen drop-offs beneath the water that would pose a safety hazard. Always be aware of water conditions and the effects of the wind when launching.

Before launching, inspect the boat and trailer for damage. Do not launch if you detect damage or find that the engine or propeller is not in good operating condition. Have any repairs made before launching.

Use courtesy when preparing the boat for launching by preparing away from the ramp on level ground before proceeding to the launch ramp.

When launching the boat on the trailer, have two or more people assist you. Since all launches are different, the following procedures are intended as guidelines only:

- Verify that the vehicle's brakes, including the parking brake, are in proper working order.
- Make sure the trailer is securely fastened to the vehicle.
- Remove the boat cover, if equipped.
- Check that the bilge drain plug is in place and all other plugs that allow water to leak into the boat are in place.
- Remove all tie-downs from the boat.

Section 11

- Attach the bow and stern docking lines.
- Attach boat fenders if necessary.
- Disconnect the trailer's light harness from the car, if applicable. Some trailers using surge brakes require the 5-pin harness connected to the vehicle to allow the trailer to be backed-up.
- Make sure the bow winch and strap are securely locked and fastened.
- Make sure the bow winch safety chains, if equipped, are in place.
- Make sure all required documentation and safety equipment are on board.
- Verify that batteries are fully charged and in good condition.
- Check fuel level; add fuel if necessary.
- Always launch with the help of another person.
- Make sure there is no one on the ramp behind the boat.
- Keep the trailer/vehicle combination as straight as possible and at 90 degrees to the shoreline.
- Back slowly down the ramp until the transom of the boat is a few inches in the water; then stop the vehicle.
- Stop the vehicle and shift into PARK (automatic transmission) or REVERSE (manual transmission). Apply the brakes and/or parking brake. If possible, use wheel blocks.
- Position the mooring lines within reach of the dock.
- Disconnect the bow winch strap and safety chains, if equipped, from the bow eye.
- Manually back the boat clear of and off the trailer into the water and secure to the dock using mooring lines.
- Remove any wheel blocks and release the vehicle brakes. Pull the trailer slowly out of the water, and secure and park in a designated area.
- Board the boat.
- Run the bilge blowers as required, if equipped.
- See the *Engine Operator's Manual* for starting procedures.
- Remove dock lines from the dock and proceed slowly away from the dock.

LOADING GUIDELINES

Follow these guidelines while loading the boat onto the trailer:

- When loading the boat on the trailer, have two or more people assist you.
- Stop, turn off the engine and secure the boat to the dock with dock lines at a position clear from where the trailer will be in the water.
- Verify that the vehicle's brakes, including the parking brake, are in proper working order.
- Disconnect the trailer's light harness from the tow vehicle, if applicable. Some trailers using surge brakes require the 5-pin harness connected to the vehicle to allow the trailer to be backed-up.
- Make sure the trailer is securely fastened to the vehicle.
- Back the trailer slowly down the ramp until it is positioned so that the boat can be loaded.
- Stop the vehicle and shift into PARK (automatic transmission) or REVERSE (manual transmission). Apply the brakes and/or parking brake. If possible, use wheel blocks.
- Position the mooring lines within reach of the dock.
- Manually position the boat onto the trailer using mooring lines. Make sure it is centered on the supports of the trailer.
- Position the bow eye into the bow stop and connect and secure the bow winch strap and safety chains, if equipped, to the bow eye.
- Secure the mooring lines inside the boat.
- Remove any wheel blocks and release the vehicle brakes. Slowly pull the trailer and boat up the ramp.
- Secure the transom to the trailer.
- Prepare for trailering as necessary.

REPORTING SAFETY DEFECTS

If you believe that your boat trailer has a defect which could cause a crash or could cause injury or death, you should immediately inform the National Highway Traffic Safety Administration (NHTSA) in addition to notifying the trailer manufacturer.

If NHTSA receives similar complaints, it may open an investigation, and if it finds that a safety defect exists in a group of trailers, it may order a recall and remedy campaign. However, NHTSA cannot become involved in individual problems between you, your dealer or the boat manufacturer.

To contact NHTSA, you may call the Vehicle Safety Hotline toll-free at 1-888-327-4236 (TTY: 1-800-424-9153); go to <https://www.nhtsa.gov>; or write to Administrator, NHTSA, 1200 New Jersey Avenue SE, Washington, DC 20590. You can also obtain other information about motor vehicle safety from <https://www.nhtsa.gov>

This Page Intentionally Left Blank

CENTURION BOATS

Section 12

GENERAL CARE AND MAINTENANCE

The boat may feature a variety of specialized systems and components. The following basic and typical information may not apply to your specific application. This section may not cover all systems or components on the boat. See the *Engine Operator's Manual* or the equipment manufacturer's information for maintenance procedures.

Maintenance procedures may require special knowledge and equipment. Always consult the boat dealer for assistance in performing service, maintenance or modifications to the boat.

Neglect of maintenance and unauthorized service work is not recommended and may void your warranty. Refer to the *Engine and Equipment Manufacturer's* maintenance schedules and requirements, and keep a detailed log of the procedures and dates completed. Always consult the boat dealer for assistance with periodic maintenance.

Before performing any general care and maintenance procedures within this section, review *Safety in Section 3*.

HULL DISCOLORATION



WARNING

Hull Damage Hazard: *If you leave the boat moored in the water for long periods of time, a condition may develop where you may experience signs of discoloration and/or "blistering" of the hull below the waterline. This is a normal condition for all fiberglass boats and does not indicate a problem with materials or workmanship. This condition is not covered under warranty. See Section 2 - Warranty for more information. If it is necessary for your boat to stay in the water, you should consider applying high-quality bottom paint for additional protection. Talk to other boaters in the area or see your dealer for recommendations.*

20-HOUR INSPECTION

A boat inspection is required between the first 15 to 20 hours of boat operation. The following maintenance must be performed at or before the 20-hour inspection by an authorized Centurion dealer. See the *Engine Operator's Manual*, *V-Drive Operator's Manual* or specific equipment operator's manuals for additional information.

- Check prop shaft alignment.
- Tighten all engine mounting bolts.
- Tighten all steering, throttle and shift system fasteners.
- Perform all recommended engine maintenance procedures.
- Inspect fuel system for any damage or leaks.
- Inspect ski pylon for damage and proper attachment.
- Check bilge pump for proper operation in manual and automatic modes.
- Inspect all Fasteners for tightness.
- Check engine and V-drive fluid levels.

NOTICE

Centurion Boats assumes no responsibility for the cost related to the 20-hour inspection. This is the owner's responsibility and is required to maintain your factory warranty.

25-HOUR ENGINE INSPECTION

After the first 25 hours of operation, it is recommended that the engine be given an inspection. Your boat dealer or PCM Premier servicing dealer should be contacted to perform the necessary checks and adjustments to ensure the proper engine performance. The following maintenance is from PCM Engine Manual that is included within each owner's package and should be performed:

- Change the engine oil and filter.
- Replace the primary fuel pre-filter.
- Check the engine alignment.
- Inspect the accessory drive belt(s) and check the tension.
- Check the fluid levels.
- Check the throttle and shift cable adjustments and check for freedom of movement.
- Cooling System - Inspect all hoses for leaks, damage and deterioration. Check all the hose clamps for adequate tightness.
- Exhaust System - Inspect the entire exhaust system for leaks, damage and deterioration. Check all the hose clamps for adequate tightness.
- Battery - Check the electrolyte level and specific gravity. Inspect the case for damage. Check the battery cables and connections.

- Engine Assembly - Check for loose, missing or damaged parts. Pay close attention to engine mounts, starter and alternator mounting fasteners.

NOTICE

PCM Engines assumes no responsibility for the cost related to the 25-hour inspection. This is the owner's responsibility.

PERIODIC MAINTENANCE

It is recommended that you read and understand the periodic maintenance procedures outlined in your *Engine Operator's Manual* and *V-Drive Operator's Manual*.

Perform the following inspections semiannually or every 100 hours.

- Perform all related periodic maintenance procedures outlined in your *Engine Operator's Manual* and *V-Drive Operator's Manual*.
- Inspect all hardware for pitting, corrosion or wear, and repair or replace as necessary.
- Clean the battery terminals and inspect the batteries and hold-downs for damage. Repair or replace as necessary.
- Check the propeller shaft coupling alignment. Contact your dealer for service recommendations.
- Check the propeller shaft seal for leakage. Repair or replace as necessary.
- Inspect and lubricate the steering system.

ENGINE

The manufacturer of the boat's engine(s) will provide a separate maintenance procedure. See the *Engine Operator's Manual* for specific information on maintenance procedures.

FUEL SYSTEM



WARNING

Fire/Explosion Hazard: Gasoline is extremely flammable and highly explosive under certain conditions.

Be sure to check the fuel hoses and connectors for leaking and deterioration before fueling and on a monthly basis.

Fuel vents are normally located in the deck in the same general area as the fuel fills. Periodically check that the fuel fills and vent lines are free of obstructions and kinks.

Check and/or replace the fuel filter periodically or clean as needed. If the filter has a water separator valve, use a catch container beneath the valve and open the valve to drain the water. Check fuel lines, vent hoses and drain hoses frequently for leaks. Replace any worn or cracked hoses.

Tightening a fitting or clamp may correct a fuel leak. If the leak continues, however, replace the line, fitting or hose immediately to prevent a build-up of fluids or gases.

Use fuel system parts certified for marine use only. Never use automotive parts in marine applications. Modern fuel systems are more complex and should only be serviced by a marine technician certified in fuel systems.

V-DRIVE

See the *PCM Engine Owner's Manual* for specific information on maintenance procedures.

STEERING SYSTEM

The steering system is the primary link for boat control and must be inspected and maintained regularly. Do not operate the boat if you suspect the steering system is malfunctioning. The following basic inspection and maintenance procedures may not apply to your steering system. For additional information contact your dealer.

 **WARNING** *Control Hazard: Improper maintenance of steering system is hazardous and can cause death or serious injury from sudden loss of control. Ensure all steering reservoirs, connections, hardware, cables and grease fittings are regularly inspected and maintained. If any steering problems are noticed, do not operate the boat and contact your dealer immediately for service assistance.*

- The rack-and-pinion helm gear box is typically a sealed and lubricated unit, which requires no additional lubrication. Contact your dealer for specific information on your helm unit.
- The steering cable requires periodic maintenance and lubrication. Contact your dealer for specific service information.

The rudder arm is connected to the rudder shaft. The rudder shaft is lubricated by the rudder stuffing box. The rudder stuffing box may be sealed or incorporate a grease fitting to allow lubrication during maintenance. Contact your dealer for specific service information.

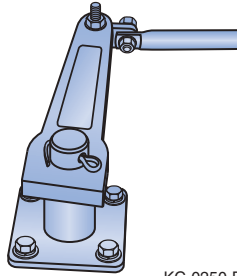

KC-0250-B

The rudder should be checked frequently for damage and tightness. If the rudder is damaged or requires service, contact your dealer for service.

ELECTRICAL SYSTEM

Before performing any work on the electrical system or the battery, review *Safety in Section 3*.

BATTERIES

⚠ WARNING *Electrical Shock Hazard: Always disconnect the batteries before performing maintenance on the DC electrical system. Electrical shock may occur if the batteries are not disconnected during maintenance on the DC electrical system.*

⚠ WARNING *Personal Injury Hazard: Always wear gloves and protective eyewear when working on and around the batteries. The batteries contain an acid called electrolyte. Avoid causing damage that could spill electrolyte into the bilge when servicing the batteries. Avoid getting salt water in or on the battery. Either condition can create a poisonous gas that is harmful if inhaled. Always disconnect the batteries before cleaning.*

⚠ CAUTION *Personal Injury Hazard: Never allow a tool to bridge across the battery terminals. Injury can result if the terminals are accidentally bridged with a tool or other conductor.*

Section 12

Today's boats can be loaded with electronics that all run off the boat's battery. Because of this, many boats will have two or more batteries: one for starting and running the engine, and one for electronics, commonly referred to as the house battery. One advantage is that the starting battery will not be drawn down when using electronics with the engine off, such as with a stereo. Another advantage is if the starting battery has lost capacity because of age, the battery switch has a 1+2 (Both) position that parallels both batteries for emergency starting. See the *Battery Switch* section of this manual for more information.

Marine batteries generally come in two types: starting and deep-cycle. Starting batteries are similar to car batteries, can supply lots of current for a short period of time and are used for starting the engine. Starting batteries should be recharged almost immediately and do not tolerate deep discharges. Deep-cycle batteries are designed for repeated discharging and recharging cycles without damage. They are used as the house battery on boats with higher DC power requirements.

All batteries have one thing in common — they run for a while, need recharging and require an eventual replacement as the capacity fades. Most marine batteries are sealed and require no maintenance other than keeping them at a full state of charge and diligently cleaning corrosion from the terminals. To maintain long life, deep-cycle batteries should not be discharged more than 50% before they are recharged.

Most marine batteries are flooded, sealed lead-acid, but there are several different battery types/chemistries that could be used. You must use caution when charging or replacing the batteries; replace batteries with the exact same type, group and capacity. If your boat is not equipped with an onboard battery charger, use a smart charger suitable to your battery type/chemistry.

 **CAUTION** ***Burst Hazard: Never use an automotive type (lead-acid) battery charger to charge a gel cell type battery. Doing so will cause damage to both the charger and battery and can cause the battery to burst. Use a battery charger specifically designed to charge gel cell type batteries.***

Always turn off the battery switch (if equipped) or disconnect the negative battery cable before servicing the electrical system.

NOTICE *The following information applies to lead-acid batteries. If you replace the batteries with batteries using different chemistry such as Li-Ion, you must follow the battery manufacturer's instructions for inspection, maintenance and charging.*

Refer to the OEM information for operation details.

General Care and Maintenance

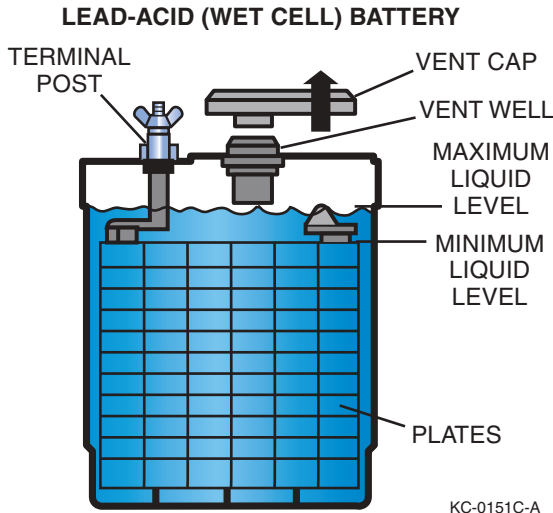

When you install a battery:

- Make sure the battery terminals are clean.
- Be certain to use correct polarity when you connect the battery cables to the battery.
- Make sure the cable connections are tight.
- Always shut down the engine before removing or attaching battery cables and never run the engine with the battery cables disconnected.
- Always remove the negative (-) cable first. Always attach the negative (-) cable last.

Check the battery frequently for signs of corrosion. If corrosion is evident, clean the terminal posts with a baking soda and water solution and a wire brush. Disconnect the battery terminals before cleaning.



WARNING

Burn Hazard: Lead-acid battery fluid can cause severe burns.

Check the fluid levels in the cells.

NOTICE

Some batteries are sealed and cannot be filled. A level of approximately 1/4 to 1/2 in. (6 to 13 mm) above the plates is sufficient. If needed, fill with distilled water; do not overfill.

Section 12

During extended periods of non-use, batteries will self-discharge and should be recharged. Before recharging, disconnect the battery terminals and remove the battery from the boat. Recharge the battery according to the directions enclosed with the battery and battery charger. When installing the battery in the boat, make sure the battery is secured in the battery box, the terminals are tight and all protective covers are in place.

Please review the operation manuals for any battery charger included with your boat by visiting NOCO's website:

<https://no.co/genius/gen>

 **WARNING** *Fire/Explosion Hazard: Hydrogen gases produced by a lead-acid battery while it is charging, or the engine is running, can cause a fire and/or an explosion.*

CIRCUIT BREAKERS AND FUSES

Never exceed the recommended fuse sizes or bypass a fuse in a circuit. Always install the proper (type and rating) fuses whenever replacing or changing fuses. Continuous fuse/breaker failures indicate a severe problem and require immediate attention.

 **WARNING** *Fire Hazard: Never reset a circuit breaker that has been automatically tripped or replace a fuse that has blown without first identifying and correcting the cause of the problem. Failure to correct the cause may result in a fire hazard.*

 **WARNING** *Fire Hazard: Installing an incorrect fuse or breaker can cause a fire.*

Some applications use circuit breaker switches to provide individual circuit protection with the ability to manually reset the breaker switch.

To reset a tripped circuit breaker, move the breaker switch to OFF. Identify and correct any problems with the circuit and unplug all loads connected to it. Wait a minimum of one minute for the breaker switch to cool and then push the breaker switch to ON. Turn the breaker switch to OFF immediately if it trips, and consult qualified personnel.

To replace a fuse, locate the fuse block and the failed fuse. Carefully remove the fuse without touching other fuses or wires. When possible, use a fuse removal/installation tool. Some accessories have in-line fuses accessible inside the helm or near the battery.



WARNING

Fire Hazard: DO NOT exceed the recommended fuse sizes or bypass the fuse safeguard. Always install the proper (type and rating) fuses whenever replacing or changing fuses.

NOTICE

A boat's electrical system is designed to protect you from electrocution, short circuits and overloads. Have a qualified electrician perform any modifications to the system such as adding electrical accessories. Some installed accessories, such as stereos, have an additional fuse located in-line with the positive lead. Other accessories may use in-line fuses near the battery.

CORROSION PROTECTION

GALVANIC CORROSION

Galvanic corrosion (electrolysis) is the deterioration of metals from the effects of electrolytic action. When two dissimilar metals are immersed in a conductive fluid such as salt water, an electric current is produced, much like a battery. As current flows between the two metals, the softer, or sacrificial, metal deteriorates.

If you operate in salt, polluted or brackish waters, the boat should be equipped with a transom-mounted sacrificial anode to prevent corrosion damage to other metal parts of your boat that are in contact with the water. The anodes are self-sacrificing and are slowly eroded by electrolytic action. These anodes are important and require periodic inspection for deterioration. Replace the anode when it is less than 50% of its original size.

NOTICE

To be effective, anodes must be bare metal. If the boat is dry-docked more than 24 hours, sand the anodes to clean oxidation from the surface.

- Zinc and aluminum anodes left in fresh water or zinc anodes used in brackish water will become covered with white oxide which effectively stops the sacrificial process and exposes the underwater gear to damage.
- Do not paint sacrificial anodes. Bottom paints/sealants on anodes will block the sacrificial process and expose the underwater gear to damage.
- Depending on local conditions, some anodes can deteriorate very quickly and must be closely monitored. See the boat dealer for recommendations.

Most propulsion units and transom-mounted accessories are equipped with one or more anodes that require periodic inspection. See the *Propulsion/Accessory Operator's Manual* for maintenance procedures.

NOTICE

Do not paint or coat sacrificial anodes or cathodes with any substance. Once covered, they do not provide protection from galvanic corrosion. Replace anodes if they have deteriorated 50% or more.

Optional, electronic cathode systems are designed to reduce the effects of electrolysis by emitting an electrical low-current charge into the water near the metal components' neutralizing electrolytic action.

SALTWATER CORROSION

Any boat exposed to salt water can be affected by the salt. However, to minimize the effects of salt water on boats, consider the following preparation and maintenance. Corrosion prevention is key and proper maintenance will mitigate the damaging effects of salt water.

If you plan to use your boat in salt water, all portions of the boat that will be submerged should be painted with an approved anti-fouling paint. This service is provided by your dealer or by someone recommended by your dealer. There is an extra charge for this service.

If you trailer your boat and use it in salt water, be sure that the bottom of the boat has a barrier between it and the bunks. If anti-fouling paint is not used, salt water trapped in the trailer bunks can cause corrosion at the point where the trailer bunk meets the hull.

In some cases you may need to have sacrificial anodes added to your boat to prevent electrolysis. Ask your dealer whether he recommends adding anodes. There is an extra charge for this service.

Some boats and/or propulsion systems may be designated as "Saltwater Series." This designates that additional design and/or materials are used to make them more resistant to the effects of salt water, but not "saltwater proof." The following maintenance also applies to saltwater series products.

Maintenance

Removing saltwater deposits from the boat as quickly as possible is the key to keeping saltwater corrosion in check.

- Rinse the boat hull and deck with fresh water and wash immediately after using the boat in salt water. Allow the boat to dry before covering it with the mooring or seat covers.
- Flushing the engine cooling system is recommended when the engine has been used in salt, polluted or brackish waters. Flush the entire engine cooling system with fresh water for at least 5 minutes after use in these waters. See the *Engine Operator's Manual* for the flushing procedure. Consult the boat dealer for suitable flushing equipment.

- You should repair paint chips and scratches when you start to notice bare metal showing. Do not paint any sacrificial anodes; rather, remove any oxidation with sandpaper.
- Cover your boat WHEN DRY with seat covers or a mooring cover to keep salt and weather off of your boat. Since most saltwater areas are very humid it is imperative that the boat be dry before it is covered. If you cover it wet you will see mildew develop.
- A yearly inspection for corrosion or deterioration of the electrical connections is recommended.
- If the boat is used primarily in salt water, wax the hull monthly and apply corrosion inhibitor to all hardware.

HARDWARE, FASTENERS AND FITTINGS

Check all fasteners, fittings, hinges, latches, rails and cleats for corrosion and tightness. Repair or replace any items that need attention. Never use automotive replacement parts when replacing marine parts.

Periodically clean all hardware with approved marine cleaners or mild soap and water. Never use abrasive cleaners or materials; they will scratch the polish and protective coatings on the hardware and cause the hardware to corrode. Applying a coating of marine-grade wax can help maintain the original shine of the hardware and help prevent corrosion.

STAINLESS STEEL AND CHROME HARDWARE

Stainless steel and chrome will normally oxidize over time, especially in marine environments. Cleaning and preventive maintenance of stainless steel and chrome hardware are crucial in maintaining appearance and functionality. If the hardware is left unattended, it can corrode, causing the hardware to appear unsightly and cause structural integrity problems.

Wash the stainless steel and chrome hardware with mild soap and water after operating the boat in corrosive environments such as salt water.

Remove rust or corrosion promptly by cleaning the hardware using a high-quality stainless steel, chrome cleaner or conditioner. Do not use any abrasive materials such as steel wool or sandpaper to clean the hardware. Do not use acids or bleach or any cleaners not intended for stainless steel or chrome, such as glass, tile or counter cleaners, as these types of cleaners can cause permanent damage. Always test a cleaner in an inconspicuous area first before applying to the complete surface.

After cleaning, protect the surface of the hardware by using a high-quality boat, automotive, stainless steel or chrome protectant or wax.

ALUMINUM HARDWARE

Periodically wash aluminum hardware with soap and water to keep it clean. If the boat is used in salt water or polluted water, wash aluminum hardware with soap and water after each use. Salt water allowed to remain on aluminum will penetrate the metal and corrode the aluminum.

It is recommended to frequently clean and coat all aluminum hardware with a metal protectant made for aluminum to protect against pitting and corrosion caused by the harsh effects of salt water. Choose an appropriate cleaner specific to your needs, as special cleaners are available for different types of aluminum hardware such as anodized, powder-coated and polished.

GENERAL MAINTENANCE AND CLEANING

 **WARNING** *Asphyxiation Hazard: Do not mix cleaning agents together; toxic vapors may be released. Read and follow safety-related precautions found on the product labels.*

REPLACEMENT AND/OR MODIFICATION OF NAVIGATION LIGHTS

Replacing navigation lights on your boat is crucial for safety and compliance with regulations. Contact our customer support to ensure that you have the right marine navigation lights installed.

First you must disconnect the battery, failure to do so will possibly result in an electrical shock. Loosen and remove any hardware holding the navigation light in place, store hardware somewhere safe. Slowly remove the navigation light and disconnect any cables. Check cable for any damage. Connect new navigation light to the cable and move it back in place. Reconnect battery and test new lights to make sure it was installed properly and works. Fasten hardware back into the original threads without over tightening.

If you need specific recommendations or further assistance, feel free to ask our customer service team!

MARINE GROWTH

If accelerated marine growth is a problem in your area, an antifouling bottom paint may be necessary to slow growth and prevent gelcoat damage. Before selecting a bottom paint, talk to the boat dealer to determine which product works best in your area. Many local variables can affect the selection of paint. Be sure to follow the paint manufacturer's directions exactly.

 **CAUTION** *When choosing an antifouling or protective bottom paint for your boat's aluminum hull, do not use any paint that contains copper or copper derivatives that may cause galvanic corrosion.*

CLEANING

Never allow any type of cleaning solution or cleaning material to come in contact with the water or be discharged into the water. The discharge of any type of debris or waste, including, but not limited to, food, trash, garbage, oil, fuel, liquids and human waste, is highly restricted, if not unlawful, in most waterways. Never discharge anything into the water.

Periodic cleaning is the best way to keep the boat looking new. Regular washing and waxing keep dirt, algae and water deposits from building up and deteriorating the finish. Keeping the boat in “show room” condition means greater personal satisfaction and higher resale value. Special cleaning products are available from the boat dealer.

HULL

NOTICE

Do not leave your boat in the water for extended periods of time. Extended mooring may cause hull surfaces to discolor and/or blister. Damage caused from this type of exposure is not covered under the Centurion Boats warranty. If extended mooring is necessary, consider using a high-quality bottom paint for additional protection.

When washing the boat, use a mild detergent with a warm water solution. Never use any kind of alkaline cleaners such as Tri-Sodium Phosphate (TSP), abrasive cleaners, solvents, ammonia or chlorine to clean gelcoat surfaces, as these will damage the gelcoat surface. Special cleaners are available from the boat dealer to remove marine growth and algae from the hull.

Wax gelcoat surfaces at least twice a season. Special marine gelcoat waxes are available from the boat dealer to prevent color fade and dirt adhesion. If the gelcoat has oxidized, chalked, dulled or faded from lack of proper maintenance, buffing may be necessary to bring back the shiny appearance. Hand buffing with #7 rubbing compound or power buffing with glazing compound #1 will quickly restore the surface; however, always seek certified assistance before attempting to restore your boat's finish.

UPHOLSTERY

Regular washing with warm soapy water is sufficient to keep the upholstery in good condition. For additional information on cleaners and upholstery maintenance, see the Upholstery Care information in your *Owner's Information Kit*.

CANVAS COVERS AND BIMINI TOPS

Regular washing with warm soapy water is sufficient to keep the canvas and bimini top in good condition. For additional information on cleaners and maintenance, see the SewLong Custom Boat Covers Owner's Manual and Great Lakes Boat Top Owner's Manual information in your *Owner's Information Kit*.

CARPET

Occasional vacuuming and washing with mild detergent and warm water or household carpet cleaners will keep the carpet clean. Thoroughly wash the detergent out of the carpet with clean water. Let the carpet dry in the sun to prevent any mildew or odor caused by moisture.

WINDSHIELD

A clean windshield is important. Your boat is equipped with a glass windshield, which can be sufficiently cleaned with a nonabrasive glass cleaner and a soft cloth. Harsh detergents, solvents, chemicals or dry cloths used on any glass windshield can scratch the surface.

BILGE SYSTEM

A boat's bilge area accumulates oil and greasy dirt over a period of time and should be cleaned periodically. Consult the boat dealer for recommendations on special bilge cleaning products and procedures.

BILGE PUMP

Periodically check the bilge pump(s) inlet screens and hoses for obstructions and debris. Foreign materials can clog the screen and hoses or become lodged in the bilge pump impeller, which can cause the pump to malfunction. Periodically check the operation of the bilge pump and float switch, if equipped. Inspect all wiring, clamps and hoses for tightness on a regular basis.

COCKPIT HEATER

The marine heater must be drained completely for winter storage. When winterizing the engine cooling system, the heater must be included. See the *Marine Heater Operator's Manual* for further information.

TRIM TAB / STINGER WAKE PLATE

Periodically inspect the trim tab for damage and leaks. Check the hydraulic pump (if equipped) fluid level periodically and fill with the recommended fluid.

WINDOW CHANNELS

Nylon pile is typically used in sliding window channels. Never use any products that contain bleaching solutions to clean window channels or seals. Use only a mild detergent and water solution for cleaning. If windows stick, spray the channels with silicone spray while working the window back and forth.

TEAK

If your boat is equipped with teak wood, consult your dealer for cleaning, maintenance and refinishing.

BALLAST TANKS

The ballast tank system must be completely drained before long periods of non-use and if the boat is to be stored in freezing temperatures to prevent damage to the system.

NOTICE

Protect the environment and natural resources by using environmentally safe products and always discard products in the proper manner.

- Remove the boat from the water and open the supply and drain seacocks to completely drain the system of water.
- If antifreeze is to be used during storage, use an environmentally safe antifreeze and follow the manufacturer's mixing instructions.
- Pour an equal amount, approximately 1 gallon (3.8 l), of antifreeze into each tank vent.
- Operate the pump in the drain mode for three seconds and stop, catching any expelled antifreeze in a proper container. Repeat the procedure for other tank(s).
- Close the water supply and drain seacocks.

NOTE — When returning your boat back to service, make sure to drain out the antifreeze mixture before returning the boat to the water.

SAFETY EQUIPMENT

Periodically check the safety equipment for damage, general condition and operation when applicable. Always replace safety equipment that is in question or in need of repair:

- Fire extinguisher
- Life jackets
- Visual distress signaling devices
- Audible signaling devices
- Navigational lights
- Emergency radios or Emergency Position Indicating Radio Beacon (EPIRB) or Personal Locator Beacon (PLB)
- First aid kit
- Batteries in electronic devices
- Ditch kit
- Life raft

GENERAL BOATING EQUIPMENT

Periodically check the general equipment on board for damage, general condition and operation when applicable. Always replace equipment that is in question or in need of repair.

- Anchors and anchor lines
- Boat hook
- Dock fenders
- Foul weather gear/clothing
- Mooring lines
- Oars/paddles
- Tool kit
- Tow line

TRAILER

Periodically check the general trailer components for damage, general condition and operation when applicable. Always replace trailer components that are in question or in need of repair.

- Lights
- Electrical connectors
- Tires (condition and pressure)
- Wheel lug nuts and studs
- Wheel valve stems
- Wheel bearings
- License plate and holder
- Rollers, bunks and hardware
- General fasteners (missing, loose or corroded)
- Safety chains or straps
- Winch, winch strap and hooks
- Trailer coupler and latch
- Frame, axle and springs
- Spare tire and wheel
- Brakes and actuator assembly

NOTE — Trailer bunks and carpet are wearable items and must be maintained.

This Page Intentionally Left Blank

CENTURION BOATS

Section 13

WINTERIZATION AND STORAGE

The boat may be equipped with a variety of specialized systems and components. The following basic and typical information may not apply to your specific application. This section may not cover all systems or components on the boat. Consult the boat dealer for assistance.

The garage specifications for your specific boat and trailer are found on the website.

Winterizing or storing the boat for extended periods of non-use requires special preparation to prevent boat and system damage. Without proper preparation, if the boat is not used or is stored for extended periods of time, internal parts of the engine may become corroded from lack of lubrication. If the boat is stored in freezing temperatures, water inside the bilge, engine cooling system or boat water systems may freeze and cause damage. Be sure to keep up with all annual maintenance during winterization.

Before performing any winterization and storage procedures within this section, review *Safety in Section 3*.

WINTERIZATION AND STORAGE PREPARATION

The following procedures will help prevent damage to the boat:

- While the boat is still in the water, fill fuel tank(s) with fresh fuel and add the proper amount of fuel stabilizer/conditioner according to the engine manufacturer's recommendations. Operate the boat for at least 15 minutes to be sure that the treated fuel has reached the engine.

NOTICE

If you plan to store the boat for more than three months in either a humid environment, extreme temperatures or outdoors, "fog" the engine with a corrosion-preventing fogging oil according to the propulsion system manufacturer's recommendations. See the Engine Operator's Manual for more information.

Section 13

- Once the boat is removed from the water, remove the bilge drain plug and the T-handle plug located under the V-drive access port immediately. Store the plugs in a plastic bag and tape it to the throttle control lever for easy accessibility the next time you use the boat.
- Inspect all sacrificial corrosion protection anodes for excessive wear and replace as necessary.
- Check all thru-hull fittings and other fasteners for tightness and leakage.
- Thoroughly clean the hull, deck and interior of the boat as soon as you remove it from the water; marine growth is easier to remove when it is wet.
- Always allow all boat compartments to air dry for a couple of days to prevent mildew from trapped moisture. If you use shrink wrap, always allow for ventilation to prevent mildew from trapped moisture.
- Apply a coat of wax to the entire surface of the boat and rust inhibitor on all metal parts.
- Clean all traces of dirt, oil, grime and grease from the engine and bilge.
- After washing, raise the bow of the boat high to allow as much water as possible to drain while performing other storage preparations.
- Touch up areas where paint has been removed.
- Prepare the engine for storage according to the *Engine Operator's Manual*. Flush the engine cooling system with clean water and/or a nontoxic antifreeze mixture approved for marine use. Never exceed the maximum engine rpm for flushing recommended as stated in the manual.
- Perform all scheduled maintenance for the engine and boat equipment. See the *Engine Operator's Manual* and all equipment manufacturer's information for periodic and annual maintenance procedures.
- Turn off all electrical switches and breakers.
- Remove all batteries from the boat. Clean, fully charge and store the batteries in an area outside the boat not subject to freezing temperatures. Never store batteries close to heat, sparks or open flames.
- Open all water drains and seacocks, and thoroughly drain all ballast tanks (if equipped) and water lines. Manually disconnect any lines that may have residual water trapped.
- Thoroughly drain all ballast tank filters (if equipped) that may have residual water trapped.
- Use nontoxic antifreeze approved for marine use to prevent freeze damage in the ballast tanks and lines. Consult your local marina or certified marine technician for recommendations for your system.
- Clean all interior upholstery, furniture, appliances, etc.
- Pest/rodent repellents may help prevent damage to the boat during storage.

ENGINE AND V-DRIVE WINTERIZATION

Proper engine winterization is dependent on the engine installed; remove only the plugs / clamps identified for your model in the PCM engine owner's manual.

Engines with closed cooling contain anti-freeze coolant in the closed system and do not need to be drained; only the sea water part of the system needs draining.

If you have a closed cooling system with a cockpit heater installed, do not drain the heater as it is plumbed in the closed part of the system.

NOTICE

Always refer to the PCM engine Owner's Manual for specific engine winterization requirements.

STORING ON A CRADLE OR BLOCKS

- When storing a boat on support other than the proper trailer, make sure the hull is supported properly to prevent hull damage. Most cradles are custom-built to support the boat's hull.
- Put the cradle, stands or blocks on a hard, level surface capable of supporting the combined weight of the cradle and the boat.
- When using blocks with jack stands, always use jack stands that are rated for more than the required load, making sure they are securely positioned so they cannot move under the load. Use a minimum of three blocks to support the keel and each side of the boat where applicable. Use a minimum total of nine jacks and/or blocks.

If stored outside:

- Position the boat to allow for adequate draining from rain or snow.
- Cover the boat to prevent the collection of rain, snow or debris. When using a cover, allow ventilation for residual moisture and condensation to escape. Never cover or plug the bilge drain hole.

NOTICE

Mooring covers are not designed to be used to protect the boat when stored outside. Use a high-quality, properly fitted canvas cover with suitable support for expected snow loads.

STORING ON A TRAILER

- Be sure the trailer supports are adjusted to properly support the boat's hull.
- Repack the trailer wheel bearings with water-resistant wheel bearing grease.
- Park the trailer and boat in a protected area to reduce possible damage from the elements and surroundings.
- Loosen tie-downs and winch line, but be sure the boat is resting properly on hull supports.
- Lift the trailer and place blocks under the trailer frame to relieve weight on trailer tires and springs. Position the boat to allow for adequate draining from rain or snow.
- Cover the boat to prevent the collection of rain, snow or debris. When using a cover, allow ventilation for residual moisture and condensation to escape. Never cover or plug the bilge drain hole.

STORING DURING THE SUMMER

The best way to store your boat is under a boat house or storage roof. A mooring cover will help reduce the effects of sun and dirt. The mooring cover can repel most water but will collect water during heavy downpours. Always remove collected water after a rain to help prevent tearing and staining. The mooring cover can suffer damage from high winds, so take proper precautions to prevent damage when possible. If you desire a canvas cover that can also withstand heavier loads, contact your dealer to get information on a custom storage cover from a local canvas maker.

RECOMMISSIONING AFTER STORAGE

- Remove blocks from under the trailer frame.
- Tighten tie-downs and the trailer winch line.
- Check tire pressure and lug nut tightness on the trailer.
- Inspect the hull for damage.
- Charge and install all batteries.
- Check the bilge blower vents for obstructions and blower operation.
- Check the bilge pump and float switch for proper operation.
- Inspect all battery and electrical wiring for loose connections and/or damage.
- Check the fuel system for leaks or damage. Verify the condition of all hoses and fuel line. Should a fuel hose need replacing, use only USCG-approved hose. Check hose labels for exact type of replacement. Be sure all hose clamps are tight.

- Check the engine and bilge for signs of nesting animals; clean as necessary.
- Check the entire engine for cracks and leaks caused by freeze damage.
- Check the condition of all hoses and clamps for tightness.
- Clean the bilge area and install the boat bilge drain plug.
- Lubricate all seacocks and check for proper operation.
- Install all drain plugs in strainers and seacocks.
- Close all drains and valves that were opened during winterization.
- Perform any annual maintenance not performed during winterization. See the *Engine Operator's Manual* and all equipment manufacturer's information for periodic and annual maintenance procedures.
- Check the engine's cooling water intake areas and screens (if equipped) for obstructions.
- If the engine uses a self-contained cooling system and was drained for storage, fill the system with fresh coolant solution. Check the *Engine Operator's Manual* for specific procedures.
- Check all engine exhaust connections for exhaust leakage or damage.
- Check and lubricate the steering system.
- Check all navigational lights.
- Check all controls, gauges, boat systems, accessories and related equipment for proper operation.
- Check all fire extinguishers for charge level.
- Inspect all safety equipment for condition and operation as applicable.
- When possible, briefly start and run the engine(s) using proper water supply equipment to check that the engine does start and there are no major operational problems.

NOTICE

If fogging oil was used during winterization, the engine will emit excessive white smoke upon initial start-up. This condition is normal and will diminish once the fogging oil has been cleared through the engine.

- Once the boat is in the water, start the engine.
- When the engine starts, watch the gauge readings closely, checking for leaks and abnormal noises.
- Keep speeds low for the first 15 minutes until the engine has reached normal operating temperature.
- See the *Engine Operator's Manual* and all equipment manufacturer's information for additional recommendations.

LIFTING

NOTICE

Consult the boat dealer for proper lifting instructions for the boat.

Attempt to lift or hoist boats only if you are qualified or experienced with this procedure. This procedure requires special equipment and experience. Do not attempt to lift or hoist the boat alone; damage, personal injury or death can occur.



WARNING *Crush Hazard: Special equipment is necessary to lift the boat and/or engine. Always use lifting equipment with sufficient capacity to lift the boat and/or engine.*

Empty water and water tanks and winterize applicable systems prior to removing the boat from the water. Consult the information for propulsion, water, waste, air conditioning and fuel systems before removal from the water. Improper winterization, lifting and storage is not covered by the warranty.

If the boat is to be removed from the water without a trailer, follow these guidelines:

- Cover lifting cables with a rubber hose or other protectors to prevent damage to the finish.
- Attach guidelines to the bow and stern to control movement.
- Use spreader bars and keep lifting pressure vertical to prevent side load damage.
- Keep the bow slightly higher than the stern to prevent engine damage.

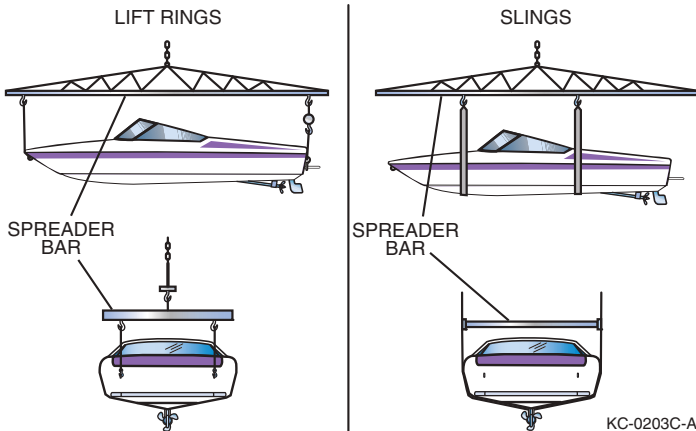

CENTURION BOATS

Section 14

TROUBLESHOOTING

The following information will assist you in identifying basic performance, mechanical and electrical problems. This information is intended as a general troubleshooting guide and may describe items that are not applicable to the boat.

The tachometer can be very useful when troubleshooting the boat's performance problems. A typical engine should maintain the same operating rpm throughout the useful life of the boat. When the normal operating rpm is known, that rpm should be used as a starting point when performance problems arise.

If you detect a problem with the engine, see the *Engine Operator's Manual*. If you detect an equipment or boat system problem, see the manufacturer's information for that item.

Before performing any troubleshooting procedures within this section, review *Safety in Section 3*.

NOTICE

Certain problems may require specialized skills and tools. Always consult qualified personnel before making any repairs or modifications.

PROBLEM	POSSIBLE CAUSES
Engine will not crank	<ul style="list-style-type: none">• Engine emergency stop switch lanyard not connected• Shift/throttle control not in the NEUTRAL position• Main circuit breaker open• Battery switch is in the OFF position• Battery terminals or wiring connections corroded• Low battery voltage• Faulty ignition switch/FOB battery dead• Engine problem

Section 14

PROBLEM	POSSIBLE CAUSES
Engine cranks but will not start	<ul style="list-style-type: none"> • No fuel in tank • Fuel tank valves closed to engine • Fuel filter clogged • Flame arrestor dirty, if equipped • Contaminated fuel • Engine problem
Poor boat performance	<ul style="list-style-type: none"> • Contaminated fuel • Uneven load distribution • Excessive load • Improper trim equipment (if equipped) position • Improper propeller selection • Excessive water in bilge • Damaged or obstructed propeller • Marine growth on hull • Damaged hull • Engine system problem • Plugged flame arrestor, if equipped
Throttle/shifting control problems	<ul style="list-style-type: none"> • Corroded cable • Excessive bends or kinks in cable • Engine/network system problem
Excessive vibration	<ul style="list-style-type: none"> • Damaged or obstructed propeller • Bent propeller shaft • Engine/network system problem
Electrical problems	<ul style="list-style-type: none"> • Blown fuse/breaker or open circuit • Loose or corroded wiring connections • Defective switch or gauge • Weak or discharged battery

PROBLEM	POSSIBLE CAUSES
<p>Ramfill tanks do not seem to be filling up, or they are full on the screen but you're listed to one side or another</p>	<ul style="list-style-type: none"> • Check the "fill" valves to see if they are opening up while underway. If they are not opening up then you will not have water entering the ballast liner. • Check the valves in the back of the boat where the Ramfill drains are located. Are the handles all the way up? If so, they are in the open position. This means when you're underway the water is rushing out of the tank (instead of staying inside the ballast liner). If this is the case, push the valve back down (make sure the clip is secured in place), then "Override" the fill for Ramfill on the Touch Vision display screen until you see water coming out of the vent.
<p>The ramfill valves are not opening</p>	<ul style="list-style-type: none"> • Are you up to 10 mph to operate Ramfill? Are you over 25 mph? • If all the valves are not working then the problem is most likely associated with the PDM. Check to make sure that all the electrical plug-ins that go to the PDM are secure. • Check the pinouts on the wires that go to the PDM to see if they are dislodged. When connected, each contact of a pinout connector must mate with the contact on the other connector that has the same function. • If the problem continues you will need to contact your local service center to determine whether the PDM needs to be replaced.

Ramfill Valve and Clip



CENTURION BOATS

Section 15

GLOSSARY OF NAUTICAL TERMS

ABOARD – On or in the boat.

ABYC – American Boat and Yacht Council, Inc.

AFLOAT – On the water.

AFT – Toward the rear or stern of the boat.

AGROUND – Touching bottom.

AMIDSHIP – Center or middle of the boat.

ANCHOR – (1) An iron casting shaped to grip the lake bottom to hold the boat.
(2) The act of setting the anchor.

ASHORE – On the shore.

ASTERN – Toward the stern.

AUTOMATIC CHARGING RELAY (ACR) – An ACR parallels (combines) batteries during charging, and isolates them when charging has stopped and after battery voltage has fallen. An ACR is intended to keep a load from discharging both of the batteries.

AUTOMATIC IDENTIFICATION SYSTEM (AIS) – An automatic tracking system used on ships and by vessel traffic services (VTS) for identifying and locating vessels by electronically exchanging data with other nearby ships, AIS base stations, and satellites.

BAIL – To remove water from the bottom of the boat with a pump, bucket, sponge, etc.

BAITWELL – A miniature livewell used to store and keep live bait alive and healthy.

BEAM – The widest point on the boat.

BEARING – Relative position or direction of an object from the boat.

BILGE – The lowest interior section of the boat hull.

BILGE KEELS – The raised areas or aluminum extrusions on the bottom of a boat that parallel the keel.

BOARDING – To enter the boat.

BOUNDARY WATERS – A body of water between two areas of jurisdiction; i.e., a river between two states.

BOW – The front of the boat.

BULKHEAD – Vertical partition (wall) in a boat.

BUNKS – Hull supports on trailer that may be covered with carpet, plastic or rollers.

BURDENED BOAT – Term for the boat that must “give-way” to boats with the right-of-way.

CAPACITY PLATE – A plate that provides maximum weight capacity and engine horsepower rating information. It is located in full view of the helm.

CAPSIZE – To turn over.

CAST-OFF – To unfasten mooring lines in preparation for departure.

CENTER LINE – A lengthwise imaginary line which runs fore and aft with the boat's keel.

CHINE – The point on a boat where the side intersects (meets) the bottom.

CLEAT – A deck fitting with ears to which lines are fastened.

CONSOLE – Also called helm. The steering wheel area of the boat.

CONTROLLER AREA NETWORK (CANBUS) – A robust bus standard designed to allow microcontrollers and devices to communicate with each other in applications without a host computer.

CRANKING BATTERY – The main battery used for engine starting and electrical circuits.

CURRENT – Water moving in a horizontal direction.

DECK – The open surface on the boat where the passengers walk.

DEEP-CYCLE BATTERIES – Special long-running batteries which can be repeatedly discharged and recharged without significant loss of power.

DIGITAL SELECTIVE CALLING (DSC) – A standard for sending pre-defined digital messages via the medium frequency (MF), high frequency (HF) and very high frequency (VHF) maritime radio systems. It is a core part of the Global Maritime Distress and Safety System (GMDSS).

DOLLY WHEEL – A rolling jack assembly at the front of the trailer used for positioning the coupler during trailer hookup.

DRAFT – The depth of the boat below the waterline, measured vertically to the lowest part of the hull.

ELECTRONIC LEAKAGE CIRCUIT INTERRUPTER (ELCI) – Installed with or in addition to the main shore power disconnect circuit breaker(s) to offer an additional level of protection from shore power faults.

ELECTRONIC NAUTICAL CHARTS (ENCs) – Vector data sets that support all types of marine navigation.

ELECTROLYSIS – The breakup of metals due to the effects of galvanic corrosion.

EMERGENCY POSITION INDICATING RADIO BEACONS (EPIRBs) – Safety devices carried by a vessel to alert search and rescue services and allow them to quickly locate you in the event of an emergency.

FATHOM – Unit of depth or measure; 1 fathom equals 6 feet.

FENDERS – Objects placed alongside the boat for cushioning. Sometimes called bumpers.

FORE – Toward the front or bow of the boat. Opposite of aft.

FREEBOARD – The distance from the water to the gunwale.

FUEL SENDING UNIT – The electrical device that is mounted on the outside of a built-in fuel tank and controls the dashboard fuel gauge.

GIVE-WAY BOAT – (1) Term for the boat that must take whatever action necessary to keep well clear of the boat with the right-of-way in meeting or crossing situations. (2) The burdened boat.

GLOBAL MARITIME DISTRESS AND SAFETY SYSTEM (GMDSS) – An internationally agreed-upon set of safety procedures, types of equipment, and communication protocols used to increase safety and make it easier to rescue distressed ships, boats and aircraft.

- GLOBAL POSITIONING SYSTEM (GPS)** – A global navigation satellite system that provides geolocation and time information to a GPS receiver.
- GROUND FAULT CIRCUIT INTERRUPTER (GFCI)** – A type of circuit breaker that measures current flow in the hot and neutral wires and immediately switches the electricity off if an imbalance of current flow is detected.
- GUNWALE** – The rail or upper edge of a boat's side.
- HEAD** – A marine toilet.
- HELM** – The steering wheel or command area.
- HULL** – The body of the boat.
- HYPOTHERMIA** – A physical condition where the body loses heat faster than it can produce it.
- IN-LINE FUSE** – A type of protective fuse located in the power wire of a direct current (DC) circuit usually near the battery.
- KEEL** – The lowest portion of the boat; extends fore and aft along the boat's bottom.
- LIFE JACKET** – A buoyant, wearable jacket that, when properly used, will support a person in the water; also see PFD.
- LIST** – Leaning or tilt of a boat toward the side.
- MAKING WAY** – Making progress through the water.
- MARINE CHART** – Seagoing maps showing depths, buoys, navigation aids, etc.
- MOORING** – An anchor, chain or similar device that holds a boat in one location.
- NATIONAL MARINE ELECTRONICS ASSOCIATION (NMEA)** – A U.S.-based marine electronics trade organization setting standards of communication between marine electronics.
- NATIONAL OCEANIC AND ATMOSPHERIC ADMINISTRATION (NOAA)** – An American scientific agency within the United States Department of Commerce that focuses on the conditions of the oceans, major waterways and the atmosphere.
- NAVIGATION AID** – Recognizable objects on land or sea such as buoys, towers or lights which are used to fix position to identify safe and unsafe waters.
- NEMA 2000** – A plug-and-play CANBUS communications standard used to connect marine instruments and engines within the vessel for integrated data exchange.
- NMMA** – National Marine Manufacturers Association.
- NO-WAKE SPEED** – The speed at which a boat travels to produce an imperceptible wake.
- PASSIVE HYDROLOCK** – A problem that occurs when water siphons through the boat's exhaust system, enters a cylinder in the engine and results in an engine starting failure. This problem is possible on any marine vessel powered by a combustible engine with exhaust risers that sit below the waterline.
- PFD** – A buoyant personal flotation device used to support a person in the water; also see Life Jacket.
- PITOT TUBE** – See Speedometer Pickup Tube.
- PLANING HULL** – A hull designed to lift, thereby reducing friction and increasing efficiency.
- PORPOISE** – A condition in which the bow bounces up and down caused by trimming the engine too far out.
- PORT** – (1) The left side of a boat when facing the bow. (2) A destination or harbor.
- PRIVILEGED BOAT** – Term used for the boat with the right-of-way.

Section 15

PULPIT – The fiberglass extension on the bow of the boat used as a place to secure your anchor.

RIGHT-OF-WAY – Term for the boat that has priority in meeting or crossing situations. The stand-on or privileged boat.

RULES OF THE ROAD – Regulations for preventing collisions on the water.

SPEEDOMETER PICKUP TUBE – Also called pitot tube. The plastic device that extends below the bottom of the boat. It connects to the speedometer with plastic flexible tubing.

SPLASHWELL – The section of an outboard-equipped boat that is just forward of the transom.

STAND ON BOAT – Term for the boat that must maintain course and speed in meeting or crossing situations. The privileged boat.

STARBOARD – The right side of the boat when looking toward the bow.

STERN – The back of the boat.

STOW – To pack the cargo.

STRONG POINT – A dedicated eye specially reinforced for the attachment of mooring lines, anchor chains, anchor lines and tow lines.

SURGE BRAKES – A type of trailer braking system designed to automatically actuate when the tow vehicle's brakes are applied.

TRANSDUCER – The unit that sends/receives signals for the depth sounder.

TRANSOM – The transverse beam across the stern.

TRIM – Fore to aft and side to side balance of the boat when loaded.

UNDERWAY – Boat in motion; i.e., not moored or anchored.

USCG – United States Coast Guard.

V-PAD – A modified vee-hull design with a small, flat area in the keel aft.

VISUAL DISTRESS SIGNAL – A device used to signal the need for assistance such as flags, lights and flares.

WAKE – The waves that a boat leaves behind when moving through the water.

WATERWAY – A navigable body of water.

WINDLASS – A mechanical device that grasps the anchor line or chain to raise or lower the anchor.

INDEX

Numerics

20-hour inspection	12-2
25-hour engine inspection	12-2
5-pin wiring connector	11-5

A

About this manual	1-1
About your new boat	1-3
Accelerating and running underway	10-14
Accessories	8-14
Accidents	4-3, 5-6
Accidents, collisions and giving assistance	5-6
Activate/deactivate profile	8-51, 8-90, 8-124
After refueling	10-9
Aids to navigation	7-6
Alcohol	4-3
Aluminum hardware	12-12
America's Waterway Watch	4-9
American Boat & Yacht Council	1-8
American Red Cross	1-8
Anchor line	10-18
Anchors and anchoring	10-18
Anodes	13-2
Antifouling bottom paint	12-12
Aquatic Invasive Species (AIS)	4-6
Aquatic vegetation/weeds	6-3
Audible (sound) signals	3-39
Audible signaling devices	3-31, 3-39
Audible signals	7-2
Audio controls	8-70
Audio screen	8-27
Auto volume	8-28

B

Backing up	11-9
Ballast controls	8-21, 8-76, 8-110
Ballast screen	8-20
Ballast tank plumbing and pumps	9-2
Ballast tank switch (optional)	8-10
Ballast tank system (optional)	9-2
Ballast tanks	12-15
Ballasts screen	8-76, 8-110

Barefooting	3-18
Basic safety rules	3-2
Batteries	9-14, 12-5
Battery	9-13
Battery management center	8-4
Battle advance tower	9-9
Before getting underway	10-1
Before refueling	10-8
Bell	7-2
Bilge pump	12-14
Bilge pump switch	8-9
Bilge pump system	9-15
Bilge system	12-14
Blower switch	8-9
Bluetooth manager	8-31
Boarding	10-3
Boat flags	6-4
Boat information form	1-10
Boat loading	10-5
Boat operator, occupants and participants	3-50
Boat owner / operator responsibilities	4-1
Boat Owners Association of The United States	1-8
Boat system failure	5-5
Boat terminology	1-3
Boating accident	4-3
Boating regulations and your responsibilities	4-1
Boating under the influence	4-3
Boat-Sharing safety	3-46
BoatU.S. Foundation for Boating Safety Hotline	1-8
Bridges and shipping channels	4-9
Buffing	12-13
Buoys	7-6, 7-9, 7-10, 7-11, 7-12

C

Canvas covers and bimini tops	12-14
Capacity plate	10-5
Capsizing and flooding	5-4
Captive touch SxS HD dash system (Ri series models)	8-13
Carbon monoxide (CO)	3-49

Carpet	12-14
CATS (Centurion Articulating Tracking System)	9-1
Centurion Fe configuration	8-71
Centurion Fe22	3-56
Centurion Fe23	3-56
Centurion Fe25	3-56
Centurion Nv Configuration	8-106
Centurion Nv213	3-57
Centurion Nv243	3-57
Centurion Ri Configuration	8-15
Centurion Ri230	3-55
Centurion Ri245	3-55
Centurion Ri265	3-54
Centurion shift driver assist (optional)	9-19
Certification standards	1-5
Charging system	9-13
Checks during and after operation	10-16
Circuit breakers	12-8
Circuit breakers and fuses	12-8
Cleaners	12-13
Cleaning	12-13
Cleaning agents	4-7
Cockpit heater	12-14
Cockpit heater switch (optional)	8-11
Cold water	6-2
Cold weather and cold or frozen water conditions	6-2
Collision	5-6
Commercial shipping safety zones	4-9
Construction and features	1-3
Control operation guidelines	8-12
Control system gauge	8-3
Corrosion	12-9
Courtesy and docking light switch	8-10
CPR	5-1
Create new	8-47, 8-84, 8-116
Crossing	7-5
Cruise	8-68
Cruising limitations	3-48

D

Dams and spillways	6-3
Danger signal	7-2
Dangerous weather	5-5

Dash controls	8-13
Daymarks/Dayboards	7-7, 7-10
DC system	9-13
Dealer settings	8-54, 8-131
Debris	6-3
Design category	1-6
Designated seating positions	3-54
Develop water sense	3-49
Disclaimer	1-7
Display	8-71, 8-102, 8-106
Distress signals	7-2
Docking	10-16
Drain plug	13-2
Driver - best practices	3-11
Driving defensively	3-45
Driving pattern	3-12
Dropzone auto tower	9-9
Drugs	4-3
Dual battery setup	9-14

E

Edit profile	8-50, 8-88, 8-122
Electric steering	9-11
Electric supply	9-13
Electrical system	9-13, 12-5
Electrolysis	12-9
Electronic steering	9-11
Emergencies	5-1, 5-6
Emergency assistance	4-4
Emergency preparation checklist	5-1
Emissions	4-7
Engine	8-104, 12-3
Engine and V-drive winterization	13-3
Engine compartment ventilation system	9-19
Engine cooling system	9-12, 13-2
Engine emergency stop switch and lanyard	3-42, 8-8
Engine exhaust system	9-13
Engine lubrication system	9-10, 9-13
Engine or boat system failure	5-5
Exhaust emissions	4-7

F

Factory reset	8-51
Falling tips for water sports	3-10
Fasteners	12-11
Favorites	8-30
Fe switch panel	8-7
Fe23 ballast tank locations	9-3

- Features8-15
 Features and options9-1
 Filing a Float plan10-2
 Fire and explosion5-2
 Fire extinguisher3-32, 3-33
 Fires3-33
 First aid/medical emergencies5-1
 Fishing4-9
 Flags6-4
 Float plan10-2
 Float switch12-14
 Fog conditions6-2
 Fogging oil13-1
 Freezing temperatures6-2, 13-1
 Fuel (gasoline)10-6, 10-7, 12-3
 Fuel management10-6
 Fuel stabilizer13-1
 Fuel suppliers10-6
 Fuel system9-12, 12-3
 Fuel filter12-4
 Fueling10-6, 10-7, 10-9
 Fuses12-8
- G**
- Galvanic corrosion12-9
 Anodes12-9
 Gauges8-17, 8-65, 8-74, 8-108
 Gelcoat12-13
 General8-97
 General boating equipment12-16
 General care and maintenance12-1
 General maintenance and
 cleaning12-12
 General safety3-2
 Getting underway10-10
 Glossary of nautical terms15-1
 Go home mode8-51, 8-89, 8-123
 Good boating practices3-2
 Gross Vehicle Weight Rating
 (GVWR)11-2
- H**
- Harbor flags and indicators6-5
 Hardware, fasteners and
 fittings12-11
 Hazard3-20, 6-3, 6-4
 Hazard information3-48
 Helm8-1, 10-11
 Helm and controls8-1
 Hitch ball and trailer coupler11-3
- Home screen8-15, 8-62, 8-71, 8-106
 Horn7-2
 Horn switch8-9
 Hull12-13
 Hull discoloration12-1
 Hull identification number1-5
 Hull identification, capacity and
 safety plates1-5
 Hurricane and severe weather
 preparedness5-7
 Hydraulic steering9-11
 Hypothermia5-1, 6-2
- I**
- Icy waters6-2
 Inclement weather6-2
 Inflatables3-16
 Insurance4-2
 Isolated danger markers7-12
- K**
- Know water sports hand signals3-10
 Knowing the boat3-46
- L**
- Lateral markers7-10
 Launching11-9
 Law of salvage5-1
 LED lighting3-43
 Left display8-62
 Legal considerations11-1
 Life jackets3-31, 3-34
 Lifting13-6
 Lighthouses7-9
 Lights and lighted structures7-8
 Limited warranty statement2-1
 Lines and knots10-20
 Loading11-11
 Loading guidelines11-11
- M**
- Maintenance12-1
 Man Overboard (MOB)5-3
 Manatee7-11
 Map controls8-38, 8-91, 8-125
 Map settings8-103
 Maps screen8-38, 8-91, 8-125
 Marine growth12-12
 Markers7-6, 7-9, 7-11
 Markers, warnings and advisories ...6-4

MARPOL treaty 4-6
Mechanical steering 9-10
Medical emergencies 5-1
Meeting head-on 7-4
Menu 8-51, 8-131
Minimum onboard personal
safety equipment 3-31
Minor lights 7-10
Minors 4-4
Monofilament fishing line 4-10
Mooring 10-17
Mooring buoys 7-7

N

National Association of State
Boating Law Administrators 1-8
National Marine Manufacturers
Association 1-8
National Oceanic and Atmospheric
Administration's National Weather
Service 1-8
National Safe Boating
Council Inc. 1-8
Nautical terminology 1-3
Naval vessel protection zones 4-8
Navigation lights switch 8-9
Navigation markers 6-4
Navigation rules and aids 7-1
Navigational lights 3-43
Navigational lights and night
operation 7-13
Negligent operation 4-4
Neutral start safety switch 8-9
Noise 4-8
Nv ballast tank locations 9-4
Nv starboard switch panel 8-6

O

Observer 3-51
Observer seat storage
compartment 8-4
Operating in hazardous
conditions 6-1
Operating the Boat 10-1
Operating under the influence 4-3
Operation by minors 4-3, 4-4
Operator's license and education 4-3
Organizations 1-8
Other special signs and markers ... 7-11
Overboard dumping 4-6

Overtaking/passing 7-3

P

Paints 4-7
PDM 8-104
People with handicaps and
elderly people 3-47
Performance 10-5
Periodic maintenance 12-3
Pets 3-47
Planing 10-14
Platform dragging 3-8, 3-49
Plug n' play ballast system 9-5
Popup 8-45, 8-96, 8-129
Power switch panel 8-4
Powering up your system 8-14
Predator power tower 9-9
Pre-departure safety checklist 10-2
Preferred channel markers 7-12
Pregnant women 3-47
Profile popup 8-46, 8-83, 8-116
Propeller selection and
replacement guidelines 9-18
Propeller strikes 3-8
Propeller strut 9-15
Protecting the boat from theft 5-8
Protecting the environment 4-5
Publications 1-7

Q

QuickSurf 9-6

R

Ramfill 9-4
Ramfill ballast operation 9-5
Ramfill ballasts 8-24, 8-77, 8-111
Range lights 7-8
Range markers 7-10
Reboot to loader 8-53
Recommended safety
equipment 3-44
Reduced visibility 6-2
References and contact
information 1-7
Refueling built-in fuel tanks 10-9
Registration certificates 4-2
Registration numbers 4-2
Regulations 4-3, 4-4, 4-7, 4-8, 7-1
Regulatory markers 7-9

- Replacement and/or modification
of navigation lights 12-12
Reporting accidents 4-3, 5-6
Reporting safety defects 11-11
Requesting assistance
(non-distress call) 5-1
Required boating safety
equipment and regulations 3-31
Restricted areas 4-5, 4-8
RGBW outputs 8-26, 8-78, 8-112
Ri switch panel 8-5
Ri245 ballast tank locations 9-3
Right display 8-15
Right-of-way 7-1
Rotational thrust 10-12
Rules of the road 7-1
Running aground 5-5
- ## S
- Safe water markers 7-11
Safety 3-1, 3-7, 4-2, 10-5
Safety and training 3-45
Safety chains 11-4
Safety decals 3-20
Safety decals and statements 3-20
Safety equipment 10-1, 12-16
Safety guidelines 3-2
Safety labels 3-20
Safety precautions 3-26
Safety statements 3-25
Saltwater corrosion 12-10
Maintenance 12-10
Save/save as 8-35, 8-83, 8-116
Sea Tow Services
International, Inc. 1-8
Seals in the engine lower unit 4-9
Seating locations 3-54
Security zones 4-8
Settings 8-97
Severe weather 6-1
Shallow water 6-3
Shift and throttle controls 8-11
Shifting 8-12, 10-12
Shock 6-2
Show trip information 8-69
Shutting down your system 8-14
Signs 7-11
Silent stinger wake plate 9-8
Single-lever controls 8-11
Situational awareness 3-45
Small boats and swimmers 3-46
Source selection 8-29
Special markers 7-10
Special needs passengers 3-47
Speed limits 4-8
Spillways 6-3
Spotter 3-51
Stainless steel and chrome
hardware 12-11
Starting 10-10
Static electricity and the fuel
system 10-6
Steering 10-11
Steering system 9-10, 12-4
Stinger wake plate 9-7
Stopping 10-11
Storage 13-1, 13-3, 13-4
Storm conditions 6-1
Storm warning 6-4
Summer storage 13-4
Surf screen 8-32, 8-80, 8-114
Surge brakes 11-5
Switches and breakers 8-4
Switching outputs 8-27, 8-80, 8-113
Switching screen 8-25, 8-78, 8-112
- ## T
- Tab controls 8-16, 8-32, 8-62
8-72, 8-80, 8-107, 8-114
Teak 12-15
The general prudential rule 7-2
Theme color 8-58
Thru-hull fittings 13-2
Toddlers 3-47
Top buttons 8-19, 8-67
Tow boat safety 3-4
Tow boat technology 9-1
Tower light switch (optional) 8-10
Towing hitch 11-2
Towing on the water 5-6
Towing vehicle 11-2
Tracks 8-43, 8-95, 8-129
Trailer 11-1, 12-17
Trailer brakes 11-5
Trailer classification 11-1
Trailer gross vehicle weight
rating 11-2
Trailer mode 8-23, 8-76, 8-110

Trailer regulations 11-1
Trailer type 11-2
Trailing and launching 11-1
Trailing guidelines 11-6
Trim tab switch (optional) 8-10
Trim tab/stinger wake plate ... 9-5, 12-14
Type B fire extinguishers 3-33
Typical power trim tabs and smart
rams 9-6
Typical shift and throttle control 8-12

U

U.S. Coast Guard (USCG) 1-8, 4-1
U.S. Coast Guard Auxiliary 1-9
U.S. Coast Guard Navigation
Center (NAVCEN) 1-9
U.S. Coast Guard Office of
Boating Safety 1-9
U.S. Coast Guard safety standards
compliance plate 1-6
U.S. Coast Guard's America's
Waterway Watch Program 1-9
U.S. Government Publishing
Office 1-9
U.S. Power Squadrons 1-9
United States Aids to Navigation
System (USATONS) 7-6
Upholstery 12-13
Using the boarding platform/ladder ... 3-
53, 10-4

V

V-drive / Direct drive 12-4
Vegetation 6-3
Vehicle towing hitch 11-2
Visibility 6-2
Visual distress signaling (VDS)
devices 3-31
Visual distress signaling devices ... 3-39
Visual distress signals (VDS) 3-41

W

Wake 4-8, 8-105
Wake feature
ballast fill and drain times 8-56
Wake tower (optional) 9-8
Wakeboarding 3-15
Wakeskating 3-16
Wakesurfing 3-18
Warranty 2-1

Washing 12-13
Waste 9-15
Water hazards 6-3
Water sports 3-5, 3-7, 3-9, 3-13,
3-14, 3-49, 3-50, 3-52
Water sports guidelines 3-50
Water Sports Industry
Association 1-9
Waypoints 8-42, 8-94, 8-128
Weather 5-5, 6-1, 6-2
Wet sounds updater 8-57
Whistle 7-2
Window channels 12-15
Windshield 12-14
Winterization and storage 13-1
Winterizing 13-1

Z

Zone 8-30



2047 Grogan Avenue, Merced, CA 95341

www.centurionboats.com

Part No. OM-26